

Signal converters, limit switches and process indicators Catalogue 2014/2015

Let's connect.

Analogue signal conditioning



Dear Customers,

The PDF versions of our catalogues offer practical additional functions, helping you to find your way around our product range and simplifying the ordering process.

In addition to the catalogue, the PDF also contains:

- Internal page links
- Links to the online catalogue

Try it out for yourself. Click the order number to obtain more detailed information and close-up images via you web browser. The links in the PDF file also enable you to go directly to the next desired catalogue page.

Further Weidmüller product catalogues can be accessed by clicking the following:



Signal Isolating Converters, Trip Amplifiers and Displays

Catalogue 4.1

Signal Isolating Converters, Trip Amplifiers and Displays

Product overview - Analogue Signal Conditioning

Intrinsically safe signal conditioners for hazardous area applications

Signal converters in 6 mm width

Signal converters

Trip amplifier for monitoring AC/DC circuits

Indicators and configurable displays

Accessories Analogue Signal Conditioning

Appendix

Technical appendix/Glossary

Index

Search according to type or order number,
Addresses worldwide

Signal Isolating Converters, Trip Amplifiers and Displays

Intrinsically safe signal converters – ACT20X Page B.6



- Analogue and binary signal interfaces to Ex Zone 0 / Division 1
- FDT/DTM software configurable
- 2 channel modules in 22.5 mm housing

Signal converter, 6 mm – ACT20M Page C.4



- Isolating and converting of temperature signals and DC signals (3-way isolation, supply isolators and passive isolators)
- Up to 2 channels with a width of 6 mm
- Power supply via the CH20M DIN rail bus

Signal converter and monitoring components, 6 mm – MCZ Page C.30



- Signal converter in terminal format
- Passive isolator, temperature/frequency converter and threshold monitoring
- Simple wiring with pluggable cross-connection channels

Network-compatible signal converters ACT20C Page D.6



- Separation and conversion of current or voltage signals
- Limit value monitoring, diagnosis, monitoring via Ethernet networks
- PC configuration with FDT/DTM software

Signal converters and monitoring components – ACT20P Page D.8



- Separation and conversion of temperature and DC signals (3-way isolation, supply isolators and passive isolators)
- Strain gauge transmitter for reading from load cells
- High levels of galvanic isolation and accuracy

Signal converters – WAVE Page D.18



- Separation and conversion of temperature and DC signals (3-way isolation, supply isolators and passive isolators)
- A large selection of standard signal- and measurement isolating transformers
- High level of galvanic isolation

Interface converters Page D.62



- RS232/ RS485/ TTY interface converter in WAVE housing
- RS232 connection with SUB-D connector
- Bi-direction communication enabled

Trip amplifiers for monitoring – WAVE Page E.4



- Monitoring DC and AC currents and voltages
- Current/voltage ranges and switching points can be set manually.
- Pluggable units for monitoring current – on DIN rail base

Displays Page F.6



- Large four-character LED display
- 1/8"-DIN-standard front-panel with IP 65 protection
- Integrated signal converter and trip amplifier

Configuration adapter

Page G.4



- USB interface adapter for configuring signal converters
- Compatible with ACT20X, WAVE TTA and ITX+ modules
- Simple installation with plug-in connector

Markers and cross-connectors

Page G.11



- Suitable MultiCard markers for all modules
- Pluggable cross-connectors for WAVE, MCZ and MICROSERIES

Calibration device

Page G.15



- Measures and simulates voltage and current signals
- Adjustable continuous level and ramping functions
- Easy to adjust with buttons on front

Product overview – Analogue Signal Conditioning

Product overview – Analogue Signal Conditioning	Introduction	A.2
	Quick select – Analogue Signal Conditioning	A.4

Analogue Signal Conditioning Qs and As

Where are analogue conditioners used?

In all types of electronic industrial and marine measurement and control systems – for example in processes such as power plants, steelworks, water and waste plants, oil and gas production and chemical processing. In fact, wherever temperature, pressure, level, flow, weight, speed, etc., is measured and controlled as part of a continuous or batch production process. Such measurement parameters – after being accurately produced – must not be degraded on their way from the field to the control room, despite external influences from the atmosphere and installation. Conversion or changes to these signals requires electronics of the highest quality, which can also withstand wide ambient temperature changes, electro-magnetic interference, vibration, corrosive or hazardous conditions.

What functions do analogue conditioners provide?

One or more of the following:

- 1) Isolation of high level DC measurement and control signals. (Why do we need isolation? – see the notes that follow later in this catalogue.)
- 2) Conversion of high level signals, such as 0...5 V input to 4...20 mA output
- 3) Amplification, linearisation and transmission of low-level sensor inputs, such as millivolts from thermocouples, into high level DC outputs to enable transmission over distances 100 m or more.
- 4) Initiation of status indications and alarms by creating relay contact closure outputs from analogue inputs.



Why do we need separate analogue modules nowadays? Surely the control system (PLC or DCS) can perform the same functions?

- 1) Sometimes this is true, but look at where the cabling from the field devices (transmitters, sensors, valves and actuators) needs to go. It will usually go not just straight to the control system. Many signals are also passed to local indicators and alarms, and each will need isolating from the others.
- 2) Often sensors - like thermocouples for temperature – need isolating, converting and linearising locally to a standardised high level signal (e.g. 4...20 mA) for long distance transmission – instead of running expensive compensation cable to the control system.
- 3) Where the control system has no isolated analogue inputs, a separate isolator will often be needed.
- 4) Where the control system cannot provide power for the sensor / transmitter and it is convenient to do this from an isolating module.
- 5) Where a high integrity, dedicated display is required, separate from the control system display, and the input needs splitting.
- 6) Where local linearisation is needed for a plant operator – for example where a liquid volume indicator is needed for filling a bulk storage tank, but the measurement is level (level to volume conversion depends on the shape of the tank).
- 7) Where the control system only takes 4...20 mA analogue inputs and the sensors provide other less common ranges, such as 0...20 mV, 2...10 V, 0...10 k Ω , 0...1 mA, 4...12 kHz, 0...5 A AC etc
- 8) Where the control system needs to be protected from electrical noise pulses on it's analogue inputs
- 9) Where expansion of the analogue inputs would mean an expensive new I/O board for the control system

How can I select the right product for my application?

- 1) Weidmüller has a formidable range of analogue conditioners, covering most application requirements, and our range is expanding. We also have some useful tools for selection and configuration.
- 2) If you cannot find a suitable product for your application, it doesn't mean we don't have one! Tell us your requirement, and if we can't provide a solution from our current range of products, there may be a customised version that we could create for you.



Quick select – Analogue Signal Conditioning

Selection table

Order No.	Product	Input									Miscellaneous	Sensor feed	Width
		Amount	0...20 mA	4...20 mA	0...10 V	0...5 V	TC	RTD	Frequency				
Intrinsically safe signal converter for the Ex zone													
8965340000	ACT20X-HDI-SDO-RNO-S	1						X			Namur Initiator		22.5 mm
8965350000	ACT20X-HDI-SDO-RNC-S	1						X			Namur Initiator		22.5 mm
8965370000	ACT20X-2HDI-2SDO-RNO-S	2						X			Namur Initiator		22.5 mm
8965380000	ACT20X-2HDI-2SDO-RNC-S	2						X			Namur Initiator		22.5 mm
8965360000	ACT20X-HDI-SDO-S	1						X			Namur Initiator		22.5 mm
8965390000	ACT20X-2HDI-2SDO-S	2						X			Namur Initiator		22.5 mm
8965400000	ACT20X-SDI-HDO-L-S	1									NPN PNP switching signal		22.5 mm
8965420000	ACT20X-2SDI-2HDO-S	2									NPN PNP switching signal		22.5 mm
8965410000	ACT20X-SDI-HDO-H-S	1									NPN PNP switching signal		22.5 mm
8965470000	ACT20X-HTI-SAO-S	1	X					X	X			X	22.5 mm
8965480000	ACT20X-2HTI-2SAO-S	2	X					X	X			X	22.5 mm
8965490000	ACT20X-HUI-SAO-S	1	X	X	X	X	X	X	X			X	22.5 mm
1318220000	ACT20X-HUI-SAO-LP-S	1	X	X	X	X	X	X	X			X	22.5 mm
8965430000	ACT20X-HAI-SAO-S	1		X							HART [®] -transparent	X	22.5 mm
8965440000	ACT20X-2HAI-2SAO-S	2		X							HART [®] -transparent	X	22.5 mm
8965450000	ACT20X-SAI-2SAO-S	1		X							HART [®] -transparent		22.5 mm
8965460000	ACT20X-2SAI-2HAO-S	2		X							HART [®] -transparent		22.5 mm
8978580000	CBX200	1									ACT20X		
Signal converter in 6 mm width													
1176020000	ACT20M-AI-2SAO-S	1	X	X	X	X							6.1 mm
1175990000	ACT20M-CI-2CO-S	1	X	X									6.1 mm
1176000000	ACT20M-AI-AO-S	1	X	X	X	X							6.1 mm
1176010000	ACT20M-AI-AO-E-S	1	X	X	X	X							6.1 mm
1175980000	ACT20M-CI-CO-S	1	X	X									6.1 mm
1176030000	ACT20M-UI-AO-S	1	X	X	X	X	X	X					6.1 mm
1176070000	ACT20M-CI-CO-ILP-S	1	X	X								X	6.1 mm
1176080000	ACT20M-2CI-2CO-ILP-S	2	X	X								X	6.1 mm
1176040000	ACT20M-CI-CO-OLP-S	1	X	X								X	6.1 mm
1176050000	ACT20M-2CI-2CO-OLP-S	2	X	X								X	6.1 mm
8965500000	ACT20-Feed-In-PRO-S	1											22.5 mm
1282490000	ACT20-Feed-In-S	1											6.1 mm
1375450000	ACT20M-BAI-AO-S	1									-10(20)...+10(20) mA, -5(10)...+5(10) V		6.1 mm
1375470000	ACT20M-BAI-2AO-S	1									-10(20)...+10(20) mA, -5(10)...+5(10) V		6.1 mm
1375480000	ACT20M-TCI-AO-S	1						x					6.1 mm
1375500000	ACT20M-TCI-AO-E-S	1						x					6.1 mm
1375510000	ACT20M-RTI-AO-S	1							x				6.1 mm
1375520000	ACT20M-RTI-AO-E-S	1							x				6.1 mm
1435590000	ACT20M-RTCI-CO-OLP-S	1							x				6.1 mm
1435610000	ACT20M-RTCI-CO-EOLP-S	1							x				6.1 mm
Standard-signal isolator													
8540180000	WAS5 CCC 0-20/0-20mA	1	X										17.5 mm
8540190000	WAZ5 CCC 0-20/0-20mA	1	X										17.5 mm
8540270000	WAS5 CVC 0-20mA/0-10V	1	X										17.5 mm
8540200000	WAS5 CCC 4-20/0-20MA	1		X									17.5 mm
8540250000	WAS5 CCC 0-20/4-20mA	1	X										17.5 mm
8540230000	WAS5 CVC 4-20mA/0-10V	1		X									17.5 mm
8447160000	WAS5 CCC HF 0-20/0-20MA	1	X										17.5 mm
8447170000	WAZ5 CCC HF 0-20/0-20MA	1	X										17.5 mm
8447250000	WAS5 CCC HF 4-20/0-20MA	1		X									17.5 mm
8447220000	WAS5 CVC HF 0-20/0-10V	1	X										17.5 mm
8447280000	WAS5 CVC HF 4-20/0-10V	1		X									17.5 mm
8444980000	WAS4 CCC DC 4-20/4-20MA	1		X									12.5 mm
8444990000	WAZ4 CCC DC 4-20/4-20MA	1		X									12.5 mm

	Output					Miscellaneous	Configuration	Auxiliary power	Rated voltage	Isolation	Connection system	Special characteristics	Page
	Amount	0...20 mA	4...20 mA	0...10 V	Relay								
	1				X		Software	24 V DC	300 V	3-way	S	With ATEX approval	B.17
	1				X		Software	24 V DC	300 V	3-way	S	With ATEX approval	B.17
	2				X	2 relay outputs	Software	24 V DC	300 V	3-way	S	With ATEX approval	B.17
	2				X	2 relay outputs	Software	24 V DC	300 V	3-way	S	With ATEX approval	B.17
	1					Transistor output	Software	24 V DC	300 V	3-way	S	With ATEX approval	B.19
	2					Transistor output	Software	24 V DC	300 V	3-way	S	With ATEX approval	B.19
	1				X		Software	24 V DC	300 V	3-way	S	With ATEX approval	B.21
	2				X		Software	24 V DC	300 V	3-way	S	ATEX approval, ignition protection group IIC	B.21
	1				X		Software	24 V DC	300 V	3-way	S	ATEX approval, ignition protection group IIB	B.23
	1	X	X		X		Software	24 V DC	300 V	3-way	S	With ATEX approval	B.11
	2	X	X		X	2 relay outputs	Software	24 V DC	300 V	3-way	S	With ATEX approval	B.11
	1	X			X		Software	24 V DC	300 V	3-way	S	With ATEX approval	B.13
	1		X					300 V	2-way	S	Output-side power supply	B.15	
	1		X		X		Software	24 V DC	300 V	3-way	S	ATEX approval, HART®- transparent	B.7
	2		X		X	2 relay outputs	Software	24 V DC	300 V	3-way	S	ATEX approval, HART®- transparent	B.7
	1		X		X		Software	24 V DC	300 V	3-way	S	ATEX approval, HART®- transparent	B.9
	2		X		X	2 relay outputs	Software	24 V DC	300 V	3-way	S	ATEX approval, HART®- transparent	B.9
	1						Software	USB				Programming accessories	G.4
	2	X	X	X			DIP	24 V DC	300 V	4-way	S		C.11
	2	X	X				DIP	24 V DC	300 V	4-way	S		C.10
	1	X	X	X			DIP	24 V DC	300 V	3-way	S		C.14
	1	X	X	X			DIP	24 V DC	300 V	3-way	S		C.15
	1	X	X				none	24 V DC	300 V	3-way	S		C.13
	1	X	X	X			Software	24 V DC	300 V	3-way	S		C.17
	1	X	X				none		300 V	2-way	S		C.18
	2	X	X				none		300 V	2-way	S		C.18
	1	X	X				none		300 V	2-way	S		C.19
	2	X	X				none		300 V	2-way	S		C.19
	1				X		none	24 V DC			S	ATEX approval	C.29
	1						none	24 V DC			S	ATEX approval	C.29
	1	x	x	x			DIP switch	24 V DC	300 V	2-way	S	ATEX approval	C.16
	2	x	x	x		2 x -10(20)...+10(20) mA	DIP switch	24 V DC	300 V	2-way	S	ATEX approval	C.12
	1	x	x	x		0(1)...5 V	DIP switch	24 V DC	300 V	2-way	S	ATEX approval	C.24
	1	x	x	x		0(1)...5 V	DIP switch	24 V DC	300 V	2-way	S	ATEX approval	C.25
	1	x	x	x		0(1)...5 V	DIP switch	24 V DC	300 V	2-way	S	ATEX approval	C.22
	1	x	x			0(1)...5 V	DIP switch	24 V DC	300 V	2-way	S	ATEX approval	C.23
	1		x			20...4 mA	DIP switch		300 V	2-way	S	Passive converter	C.20
	1		x			20...4 mA	DIP switch		300 V	2-way	S	Passive converter	C.21
	1	X						24 V DC	300 V	3-way	S		D.32
	1	X						24 V DC	300 V	3-way	Z		D.32
	1			X				24 V DC	300 V	3-way	S		D.33
	1	X						24 V DC	300 V	3-way	S		D.34
	1		X					24 V DC	300 V	3-way	S		D.32
	1			X				24 V DC	300 V	3-way	S		D.34
	1	X						24 V DC	300 V	3-way	S	Limiting frequency >15 kHz	D.28
	1	X						24 V DC	300 V	3-way	Z	Limiting frequency >15 kHz	D.28
	1	X						24 V DC	300 V	3-way	S	Limiting frequency >15 kHz	D.29
	1			X				24 V DC	300 V	3-way	S	Limiting frequency >15 kHz	D.28
	1			X				24 V DC	300 V	3-way	S	Limiting frequency >15 kHz	D.29
	1		X					24 V DC	300 V	2-way	S	Output-side power supply	D.38
	1		X					24 V DC	300 V	2-way	Z	Output-side power supply	D.38

Connection system: S = screw / Z = tension clamp, ILP (Input Loop Powered) = Input Loop Powered, OLP (Output Loop Powered) = Output Loop Powered

Quick select – Analogue Signal Conditioning

Selection table

Order No.	Product	Input									Miscellaneous	Sensor feed	Width
		Amount	0...20 mA	4...20 mA	0...10 V	0...5 V	TC	RTD	Frequency				
Standard-signal isolator													
8445010000	WAS4 CCC DC 4-20/0-20mA	1		X									12.5 mm
8445040000	WAS4 CVC DC 4-20/0-10V	1		X									12.5 mm
8445050000	WAZ4 CVC DC 4-20/0-10V	1		X									12.5 mm
8540310000	WAS5 VCC 0-10V/0-20MA	1			X								17.5 mm
8540320000	WAZ5 VCC 0-10V/0-20MA	1			X								17.5 mm
8540290000	WAS5 VCC 0-10V/4-20MA	1			X								17.5 mm
8540300000	WAZ5 VCC 0-10V/4-20MA	1			X								17.5 mm
8540330000	WAS5 VVC 0-10V/0-10V	1			X								17.5 mm
8540340000	WAZ5 VVC 0-10V/0-10V	1			X								17.5 mm
8561610000	WAS5 VVC HF +/-10V/+10V	1									-10...+10 V		17.5 mm
8447310000	WAS5 VCC HF 0-10/0-20MA	1			X								17.5 mm
8447340000	WAS5 VCC HF 0-10/4-20MA	1			X								17.5 mm
8447370000	WAS5 VVC HF 0-10/0-10V	1			X								17.5 mm
8447380000	WAZ5 VVC HF 0-10/0-10V	1			X								17.5 mm
8411190000	MCZ CCC 0-20mA/0-20mA	1	X										6 mm
8444950000	WAS5 CCC LP 0-20/0-20mA	1	X										17.5 mm
8444960000	WAZ5 CCC LP 0-20/0-20mA	1	X										17.5 mm
8463580000	WAS5 CCC LP 0-20/0-20mA	2	X										17.5 mm
8463590000	WAZ5 CCC LP 0-20/0-20mA	2	X										17.5 mm
8543720000	WAS5 OLP	1	X	X	X	X							17.5 mm
8543730000	WAZ5 OLP	1	X	X	X	X							17.5 mm
7940024139	WAVEPak DC/DC	1	X		X							X	12.5 mm
Network-compatible signal converters													
1334490000	ACT20C-AI-A0-MTCP-S	1	X	X	X							X	22.5 mm
Standard signal isolators													
7760054114	ACT20P-CI-CCO	1	x	x							2-/3-wire transmitter	X	12.5 mm
7760054115	ACT20P-CI-2CO	1	x	x							2-/3-wire transmitter	X	12.5 mm
7760054117	ACT20P-2CI-2CO-12	2	x	x									12.5 mm
Universal isolator													
8560750000	WAZ4 PRO DC/DC	1	X	X	X						User adjustable: +/-20 mV...+/-200 V +/-0.1 mA...+/-100 mA		12.5 mm
8560740000	WAS4 PRO DC/DC	1	X	X	X								12.5 mm
Standard-signal duplicator													
8581160000	WAS5 CCC 20LP	1		X									17.5 mm
8581170000	WAZ5 CCC 20LP	1		X									17.5 mm
Universal measuring transducer													
8939670000	WAS6 TTA	1	X	X	X	X	X	X	X		User adjustable: -200...500 mV -20...50 V 2 Hz...100 kHz	X	45 mm
8939680000	WAZ6 TTA	1	X	X	X	X	X	X	X			X	45 mm
8964310000	WAS6 TTA EX	1	X	X	X	X	X	X	X			X	45 mm
8964320000	WAZ6 TTA EX	1	X	X	X	X	X	X	X		RTD, TC, resistor, potentiometer	X	45 mm
7940016563	ITX+ 4-20mA/4-20mA	1	X	X	X	X					User adjustable: -5...+10 V -100...+200 mV -10...+20 mA		12.5 mm

	Output					Miscellaneous	Configuration	Auxiliary power	Rated voltage	Isolation	Connection system	Special characteristics	Page
	Amount	0...20 mA	4...20 mA	0...10 V	Relay								
	1	X						24 V DC	300 V	2-way	S	Output-side power supply	D.38
	1			X				24 V DC	300 V	2-way	S	Dual-side power supply	D.39
	1			X				24 V DC	300 V	2-way	Z	Dual-side power supply	D.39
	1	X						24 V DC	300 V	3-way	S		D.35
	1	X						24 V DC	300 V	3-way	Z		D.35
	1		X					24 V DC	300 V	3-way	S		D.35
	1		X					24 V DC	300 V	3-way	Z		D.35
	1			X				24 V DC	300 V	3-way	S		D.36
	1			X				24 V DC	300 V	3-way	Z		D.36
	1					-10...+10 V		24 V DC	300 V	3-way	S	Limiting frequency >15 kHz	D.31
	1	X						24 V DC	300 V	3-way	S	Limiting frequency >15 kHz	D.30
	1		X					24 V DC	300 V	3-way	S	Limiting frequency >15 kHz	D.30
	1			X				24 V DC	300 V	3-way	S	Limiting frequency >15 kHz	D.31
	1			X				24 V DC	300 V	3-way	S	Limiting frequency >15 kHz	D.31
	1	X						100 V	2-way	Z		Passive isolator ILP	C.32
	1	X						300 V	2-way	S		Passive isolator ILP	D.43
	1	X						300 V	2-way	Z		Passive isolator ILP	D.43
	2	X						300 V	2-way	S		Passive isolator ILP	D.43
	2	X						300 V	2-way	Z		Passive isolator ILP	D.43
	1		X				DIP switch	300 V	2-way	S		Passive isolator OLP	D.42
	1		X				DIP switch	300 V	2-way	Z		Passive isolator OLP	D.42
	1	X		X			Pluggable bridge	24 V DC	300 V	3-way	S		D.27
	1	X	X	X			Software	24 V DC	300 V	4-way	S	Network-compatible, Ethernet	D.7
	1	X	X					24 V DC	300 V	3-way	S	HART transparency	D.12
	2	X	X					24 V DC	300 V	3-way	S	HART transparency	D.11
	2	X	X					24 V DC	300 V	3-way	S	HART transparency	D.13
	1	X	X	X		Adjustable: 0/2...+/-10 V	DIP switch	22...230 V AC/DC	600 V	3-way	Z		D.26
	1	X	X	X		0/1...+/-5 V 0...+/-20 mA	DIP switch	22...230 V AC/DC	600 V	3-way	S		D.26
	2		X					300 V	2-way	S		Passive isolator OLP	D.40
	2		X					300 V	2-way	Z		Passive isolator OLP	D.40
	3	X	X	X	X	1 analogue output, 2 relay outputs	Software	18...264 V AC/DC	300 V	3-way	S		D.22
	3	X	X	X	X			300 V	3-way	Z			D.22
	3	X	X	X	X			300 V	3-way	S		With ATEX approval	D.23
	3	X	X	X	X			300 V	3-way	Z		With ATEX approval	D.23
	1		X				Software		300 V	2-way	S	Passive isolator OLP	D.25

Connection system: S = screw / Z = tension clamp, ILP (Input Loop Powered) = Input Loop Powered, OLP (Output Loop Powered) = Output Loop Powered

Quick select – Analogue Signal Conditioning

Selection table

Order No.	Product	Input									Miscellaneous	Sensor feed	Width
		Amount	0...20 mA	4...20 mA	0...10 V	0...5 V	TC	RTD	Frequency				
Frequency measuring transducer													
8581180000	WAS4 PRO Freq	1						X			2- and 3-wire PNP/NPN;	12.5 mm	
8581190000	WAZ4 PRO Freq	1						X			Namur Initiator, push-pull step	12.5 mm	
8461480000	MCZ CFC 0-20MA	1	X									6 mm	
8461470000	MCZ VFC 0-10V	1			X							6 mm	
Strain gauge transmitter													
1067250000	ACT20P-BRIDGE-S	1									adjustable +/-10 mV...+/- 50 mV	22.5 mm	
AC/DC measuring transducer													
8581220000	WAS2 VMA V ac	1									Adjustable: 0...450 V AC	22.5 mm	
8581230000	WAZ2 VMA V ac	1										22.5 mm	
8528650000	WAS1 CMA LP 1/5/10A ac	1									Adjustable: 0...10 A AC	22.5 mm	
8528660000	WAZ1 CMA LP 1/5/10A ac	1										22.5 mm	
8523400000	WAS1 CMA 1/5/10A ac	1									Adjustable: 0...10 A AC	22.5 mm	
8523410000	WAZ1 CMA 1/5/10A ac	1										22.5 mm	
8526610000	WAS2 CMA 5/10A uc	1									Adjustable: 0...10 A AC/DC	22.5 mm	
8526620000	WAZ2 CMA 5/10A uc	1										22.5 mm	
8545830000	WAS2 CMA 20/25/30A uc	1									Adjustable: 0...30 A AC/DC	22.5 mm	
8545840000	WAZ2 CMA 20/25/30A uc	1										22.5 mm	
8513330000	WAS2 CMA 40/50/60A uc	1									Adjustable: 0...60 A AC/DC	22.5 mm	
8526590000	WAZ2 CMA 40/50/60A uc	1										22.5 mm	
Temperature measuring transducer													
8560720000	WAS5 PRO Thermo	1					X					17.5 mm	
8560730000	WAZ5 PRO Thermo	1					X					17.5 mm	
8432300000	WTS4 THERMO	1					X					12.5 mm	
8432310000	WTZ4 THERMO	1					X					12.5 mm	
8560700000	WAS5 PRO RTD	1						X				17.5 mm	
8560710000	WAZ5 PRO RTD	1						X				17.5 mm	
8679490000	WAS5 PRO RTD 1000	1						X				17.5 mm	
8638950000	WAS5 PRO RTD Cu	1						X				17.5 mm	
8432220000	WTZ4 PT100/2 C 0/4-20mA	1						X				12.5 mm	
8432160000	WTZ4 PT100/3 C 0/4-20mA	1						X				12.5 mm	
8432280000	WTZ4 PT100/4 C 0/4-20mA	1						X				12.5 mm	
8432229999	WTZ4 PT100/2 C 0/4-20mA variabel	1						X				12.5 mm	
8432169999	WTZ4 PT100/3 C 0/4-20mA variabel	1						X				12.5 mm	
8432289999	WTZ4 PT100/4 C 0/4-20mA variabel	1						X				12.5 mm	
8432250000	WTZ4 PT100/4 V 0-10V	1						X				12.5 mm	
8432190000	WTZ4 PT100/2 V 0-10V	1						X				12.5 mm	
8432130000	WTZ4 PT100/3 V 0-10V	1						X				12.5 mm	
Temperature measuring transducer													
8432259999	WTZ4 PT100/4 V 0-10V variabel	1						X				12.5 mm	
8432199999	WTZ4 PT100/2 V 0-10V variabel	1						X				12.5 mm	
8425720000	MCZ PT100/3 CLP 0...100C	1						X				6 mm	
8483680000	MCZ PT100/3 CLP 0...120C	1						X				6 mm	
8604420000	MCZ PT100/3 CLP 0...150C	1						X				6 mm	
8473010000	MCZ PT100/3 CLP 0...200C	1						X				6 mm	
8473020000	MCZ PT100/3 CLP 0...300C	1						X				6 mm	
8473000000	MCZ PT100/3 CLP -50C...+150C	1						X				6 mm	
8604430000	MCZ PT100/3 CLP -40C...100C	1						X				6 mm	

Amount	Output					Miscellaneous	Configuration	Auxiliary power	Rated voltage	Isolation	Connection system	Special characteristics	Page
	0...20 mA	4...20 mA	0...10 V	Relay									
1	X	X	X			0...5 V	DIP switch	24 V DC	300 V	3-way	S		D.55
1	X	X	X			0...5 V	DIP switch	24 V DC	300 V	3-way	Z		D.55
1						Frequency: 0...1/ 4/ 8/ 16 kHz		24 V DC	100 V	2-way	Z	Frequency output	C.34
1						Frequency: 0...1/ 4/ 8/ 16 kHz		24 V DC	100 V	2-way	Z	Frequency output	C.34
1	X			X				10...60 V DC	300 V	3-way	S		D.17
1	X	X					DIP switch	24 V DC	300 V	3-way	S		D.60
1	X	X					DIP switch	24 V DC	300 V	3-way	Z		D.60
1		X					DIP switch		300 V	2-way	S	Passive converter OLP	D.58
1		X					DIP switch		300 V	2-way	Z	Passive converter OLP	D.58
1	X	X					DIP switch	24 V DC	300 V	2-way	S	Output-side power supply	D.58
1	X	X					DIP switch	24 V DC	300 V	2-way	Z		D.58
1	X	X	X				DIP switch	24 V DC	300 V	2-way	S	Input-side power supply	D.56
1	X	X	X				DIP switch	24 V DC	300 V	2-way	Z		D.56
1	X	X	X				DIP switch	24 V DC	300 V	2-way	S	Input-side power supply	D.56
1	X	X	X				DIP switch	24 V DC	300 V	2-way	Z		D.56
1	X	X	X				DIP switch	24 V DC	300 V	2-way	S	Input-side power supply	D.57
1	X	X	X				DIP switch	24 V DC	300 V	2-way	Z		D.57
1		X					DIP switch	24 V DC	300 V	3-way	S		D.52
1		X					DIP switch	24 V DC	300 V	3-way	Z		D.52
1	X	X	X				DIP switch	24 V DC			S		D.53
1	X	X	X				DIP switch	24 V DC			Z		D.53
1	X	X	X				DIP switch	24 V DC	300 V	3-way	S		D.44
1	X	X	X				DIP switch	24 V DC	300 V	3-way	Z		D.44
1	X	X	X				DIP switch	24 V DC	300 V	3-way	S		D.46
1	X	X	X				DIP switch	24 V DC	300 V	3-way	S		D.48
1	X	X					Potentiometer	24 V DC			Z		D.51
1	X	X					Potentiometer	24 V DC			Z		D.50
1	X	X					Potentiometer	24 V DC			Z		D.49
1	X	X					Potentiometer	24 V DC			Z		D.51
1	X	X						24 V DC			Z	Special adjustment	D.50
1	X	X						24 V DC			Z	Special adjustment	D.49
1			X				Potentiometer	24 V DC			Z		D.49
1			X				Potentiometer	24 V DC			Z		D.51
1			X				Potentiometer	24 V DC			Z		D.50
1				X				24 V DC			Z	Special adjustment	D.49
1				X				24 V DC			Z	Special adjustment	D.51
1		X									Z	Passive converter OLP	C.33
1		X									Z	Passive converter OLP	C.33
1		X									Z	Passive converter OLP	C.33
1		X									Z	Passive converter OLP	C.33
1		X									Z	Passive converter OLP	C.33
1		X									Z	Passive converter OLP	C.33
1		X									Z	Passive converter OLP	C.33

Connection system: S = screw / Z = tension clamp, ILP (Input Loop Powered) = Input Loop Powered, OLP (Output Loop Powered) = Output Loop Powered

Quick select – Analogue Signal Conditioning

Selection table

Order No.	Product	Input									Miscellaneous	Sensor feed	Width
		Amount	0...20 mA	4...20 mA	0...10 V	0...5 V	TC	RTD	Frequency				
Monitoring modules													
8260280000	MCZ SC 0-10V	1			X								6 mm
8227350000	MCZ SC 0-20mA	1	X										6 mm
8543820000	WAS5 DC/Alarm	1	X	X	X								17.5 mm
8543880000	WAZ5 DC/Alarm	1	X	X	X								17.5 mm
8705640000	WAS5 VMR 1ph	1									Adjustable: 24...260 V AC/DC 1-phase reset input		17.5 mm
8705630000	WAS2 VMR 3ph	1									Adjustable: 80...250 V AC/DC 3-phase 200...400 V AC/DC 1-phase		22.5 mm
8516560000	WAS2 CMR 1/5/10A ac	1									0...10 A AC		22.5 mm
8516570000	WAZ2 CMR 1/5/10A ac	1									0...10 A AC		22.5 mm
8513340000	WAS2 CMR 20/40/60A ac	1									0...60 A AC		22.5 mm
8526600000	WAZ2 CMR 20/40/60A ac	1									0...60 A AC		22.5 mm

	Output					Miscellaneous	Configuration	Auxiliary power	Rated voltage	Isolation	Connection system	Special characteristics	Page
	Amount	0...20 mA	4...20 mA	0...10 V	Relay								
	2				X			24 V DC			Z		C.35
	2				X			24 V DC			Z		C.35
	2				X		DIP switch	24 V DC	300 V	3-way	S	Adjustable switching thresholds	E.4
	2				X		DIP switch	24 V DC	300 V	3-way	Z	Adjustable switching thresholds	E.4
	1				X	CO contact	DIP switch		300 V	3-way	S	Adjustable switching thresholds, supply from the measurement circuit	E.8
	1				X	Monitoring of low and surge voltages	DIP switch		600 V	2-way	S	Adjustable switching thresholds, supply from the measurement circuit	E.9
	1				X		DIP switch	24 V DC	300 V	2-way	S	Adjustable switching thresholds	E.5
	1				X		DIP switch	24 V DC	300 V	2-way	Z	Adjustable switching thresholds	E.5
	1				X		DIP switch	24 V DC	300 V	2-way	S	Adjustable switching thresholds	E.5
	1				X		DIP switch	24 V DC	300 V	2-way	Z	Adjustable switching thresholds	E.5

Connection system: S = screw / Z = tension clamp, ILP (Input Loop Powered) = Input Loop Powered, OLP (Output Loop Powered) = Output Loop Powered

Intrinsically safe signal conditioners for hazardous area applications

Intrinsically safe signal conditioners for hazardous area applications

Intrinsically safe signal conditioners for hazardous area applications - Overview	B.2
ACT20X - Overview	B.4
Current supply isolator	B.6
Current output isolator	B.8
Temperature transducer	B.10
Universal measurement and signal isolator-converter	B.12
NAMUR isolating switching amplifier	B.16
Valve control module	B.20

Intrinsically safe signal conditioners for hazardous area applications

ACT20X signal converters

The ACT20X is a completely new line of signal converter products for the Ex zone. These compact modules require only 11 mm per channel and take up very little space in the electrical cabinet. Weidmüller has specifically designed the ACT20X line for process automation applications in Ex and non-Ex zones. The 17 different variants can process all standard input signals (such as 2-wire, HART®, NAMUR-, RTD, thermocouple or DC signals) from Ex zone 0. They can also handle digital or analogue signals from Ex-zone field devices to the controller. The integrated relay output issues an alert in the event of a malfunction; this makes troubleshooting easier and reduces facility down times. The WI-Manager configuration software is based on FDT (Field Device Tool) technology. The software allows you to configure all ACT20X products with your PC so that they can be custom-fit to a wide variety of process applications. Weidmüller provides a device type manager (DTM) for the ACT20X modules that can be used in any FDT-based frame. The DTMs allow you to configure different devices quickly and accurately. They also enable you to analyse measurements and diagnostics data. The DTM can also be used to clearly identify the connected device. The FDT frame application “WI Manager” and the device-specific DTMs are available from Weidmüller free of charge. The ACT20X modules can be used in a temperature range from -20 °C to +60 °C without limitations. The modules can be installed in the safe zone or in the explosion risk area of Zone 2. The ACT20Xs always deliver a pure, interference-free signal

thanks to their accuracy, temperature stability and high insulation strength. They can easily be used around the globe since they already have all the necessary international approvals, including ATEX, ICEEX, GOST and FM.

The newest member of the ACT20X family is the ACT20X-HUI-SAO-LP. This offers an intrinsically safe input for 0/4 to 20 mA, 0 to 10 V, temperature and resistance signals, and separates the Ex zone from the safe zone. The narrow 12.5 mm module is supplied via the 4 to 20 mA output.

Features

- International approvals for Zone 0, 1 and 2 (IECEX, ATEX) and Class 1 Division 1 and 2 (FM)
- Analogue and binary signal interface to Zone 0/Div.1 for explosion-risk inputs and outputs
- All standard input signals (4 to 20 mA HART®, NAMUR-, RTD- or thermocouple signals) out of Ex zone 0, 1 or 2
- Two-channel type saves space in the electrical cabinet and reduces installation costs
- HART® transparent signal isolator
- Integrated alarm contact
- Configuration over FDT/DTM standard with the frame application “WI Manager”





ACT20X

ACT20X – intrinsic safety signal conditioners for hazardous areas

PC-configurable conditioners family for hazardous areas in the new Weidmüller electronics housing for installation in safe or hazardous areas.

ACT20X meets the arduous requirements of the process industry where potentially explosive fluids are controlled. The range connects to sensors and actuators in the hazardous area, isolates their signals and limits the energy passed to them. On the input side ACT20X models can process d.c.,

temperature, Namur and volt-free contact signals. On the output side field devices in the Ex area are controlled via the ACT20X with analogue or digital signals. All ACT20X products are characterised by insulation, accuracy and high temperature stability.

The digital 2-channel versions with width of 22.5 mm are available with either transistor or relay output. Due to this high component density, the space requirements and installation costs are reduced accordingly.





Configuration via FDT

All modules can be quickly and conveniently configured with manufacturer-independent FDT/DTM software.

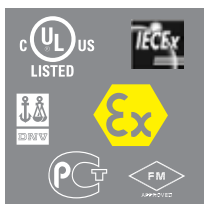

Worldwide application

Fulfills the strict standards and requirements of the process industry. Can be used worldwide due to international and local approvals ATEX, IECEx, CULUS, FM, GOST and DNV.



Intelligent connection system

Pluggable, coded, with release lever. The release lever simplifies maintenance and allows disconnection without damaging the cables.

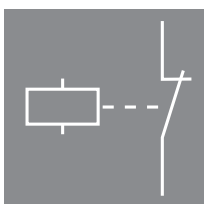

Alarm function

No laborious troubleshooting. Alarm function integrated for cable or sensor errors. In case of failures, a diagnostic signal is sent to the control system.



Robust

Wide ambient temperature range from – 20 °C ... + 60 °C.



Current supply isolator, HART® Transparent



Current output isolator, HART® Transparent



Temperature transducer



Universal measurement and signal isolator/converter



NAMUR disconnect-switch amplifier



Valve control component

ACT20X

Current-supply isolator, HART® Transparent

The ACT20X-HAI-SAO current supply isolator is a HART®-protocol transparent signal isolator for analogue input signals from Ex zone 0. It provides an analogue signal for the safe zone on the output side. It is available in a single-channel or double-channel version.

EX area Zone 0, 1, 2, 20, 21, 22

Safe area Zone 2 / FM Class 1, Division 2

Input Signals



Output Signals

Analogue, 4...20 mA

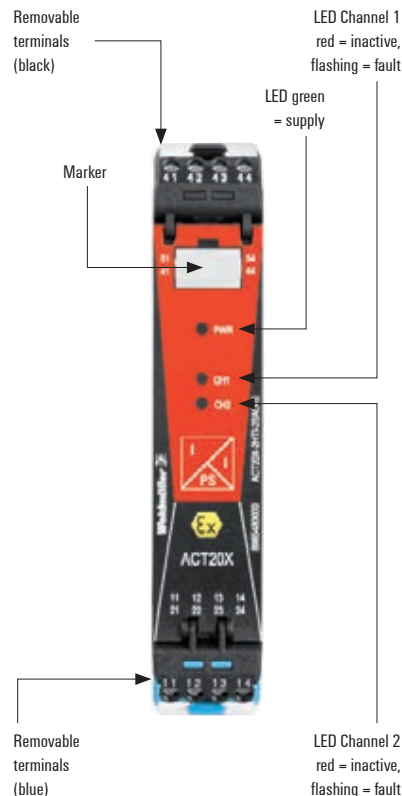
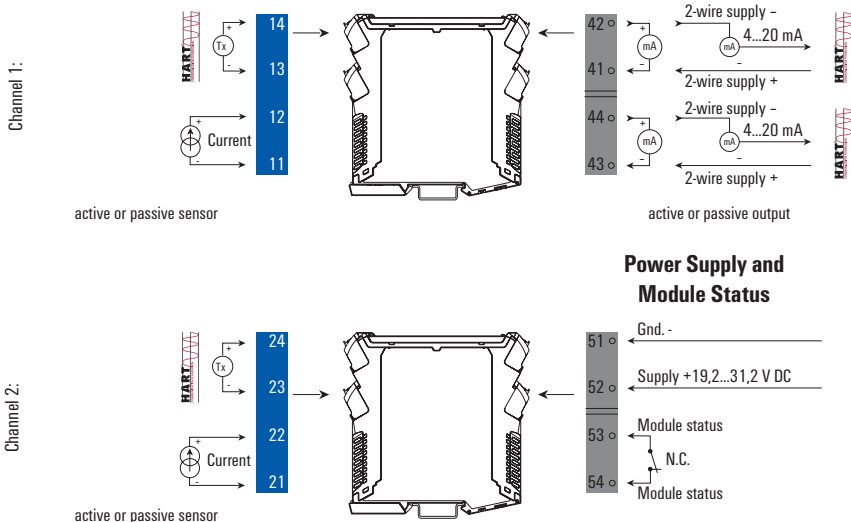

Ex label (excerpt)

ATEX	FM	U_o/U_i	0 V / 30 V
II 3 G Ex nA nC IIC T4 Gc	Installation in CL I DIV2 GP A-D T4	I_o/I_i	0 mA / 120 mA
II (1) G [Ex ia Ga] IIC/IIB/IIA	KI. III ABT 1/2 GP A-G or	P_o/P_i	0 mW / 0,85 W
II (1) D [Ex ia Da] IIIC	KI. I Zn2 AEx/Ex nA nC [ia] IIC T4	L_i	0 μ H
	Example:	C_i	2 nF
IECEX	ATEX version,	IIC	$C_o = 0,08 \mu$ F, $L_o = 3$ mH
Ex nA nC IIC T4 Gc	Ex input, External Current Source:	IIB	$C_o = 0,6 \mu$ F, $L_o = 12$ mH
[Ex ia Ga] IIC/IIB/IIA	(More details in ATEX certificate)	IIA	$C_o = 2,15 \mu$ F, $L_o = 25$ mH

Application example: Measuring temperature with a head transmitter, signal transmission with HART®

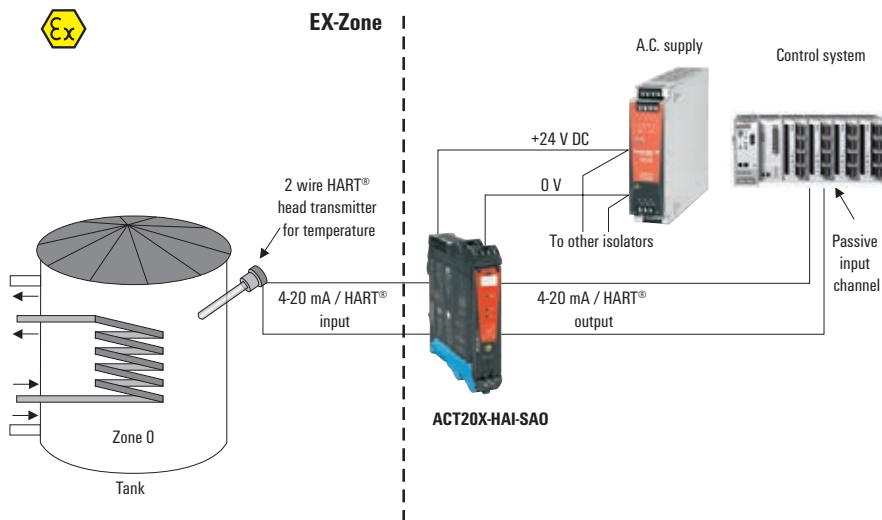

Current supply isolator

- Converts analogue signals from Ex zone 0 into analogue output signals for safe zones.
- Active and passive current inputs/outputs
- HART® - transparent
- PC configuration with FDT/DTM software, download link at www.weidmueller.com
- Relay output for failure alarm
- 2-channel module, can also be used as a signal splitter

ACT20X-HAI-SA0-S / 2HAI-2SA0-S

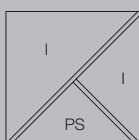

Technical data

Input	
Input current	4...20 mA
Sensor supply	≤ 28 V DC
Residual ripple (current loop)	< 7,5 mV _{eff}
Output analogue	
Output current	3,5 - 23 mA
Output signal limit	< 28 mA
load impedance current	≤ 600 Ω
2-wire supply	≤ 26 V DC
Accuracy	< 0,1% span
Temperature coefficient	< 0,01% of span/°C (TU)
Step response time	≤ 5 ms
Cut-off frequency (-3 dB)	0,5...2,5 kHz @ 3,5...23 mA bi-directional HART® signal
Alarm output	
Type	Relay, 1 NC (voltage-free)
Nominal switching voltage	≤ 125 V AC / 110 V DC (safe area) ≤ 32 V AC / 32 V DC (Zone 2)
Continuous current	≤ 0,5 A AC / 0,3 A DC (safe zone), ≤ 0,5 A AC / 1 A DC (Zone 2)
Power rating	≤ 62,5 VA / 32 W (safe area) ≤ 16 VA / 32 W (Zone 2)
General data	
Supply voltage	19,2 - 31,2 V DC
Power consumption	≤ 3 W (2 channels)
Ambient temperature / Storage temperature	-20 °C...+60 °C / -20 °C...+85 °C
Approvals	
Approvals	cULus; DEKRAATEX; DETNORVER; FMEX; GOSTEX; GOSTME25; IECExDEK
Insulation coordination	
Insulation voltage	2,6 kV (input / output)
Rated voltage	300 V
EMC standards	DIN EN 61326

Dimensions	
Clamping range (nominal / min. / max.)	mm ²
Depth x width x height	mm
Note	

Screw connection	
2,5 / 0,5 / 2,5	
113,6 / 22,5 /	

Ordering data

Type	Qty.	Order No.
1-channel version		
ACT20X-HAI-SA0-S	1 ST	8965430000
2-channel version		
ACT20X-2HAI-2SA0-S	1 ST	8965440000

CBX200 USB configuration adapter - 8978580000

ACT20X

Current output isolator, HART® Transparent

The ACT20X-SAI-HAO current output isolator is HART®-transparent. The input is connected to the safe area controller or PLC, and the output is connected to an analog actuator in a hazardous area, e.g. Zone 0. It is available in a single-channel or double-channel version.

EX area Zone 0, 1, 2, 20, 21, 22

Safe area Zone 2 / FM Class 1, Division 2

Ex Output signals



Input signals

Analogue, 4...20 mA

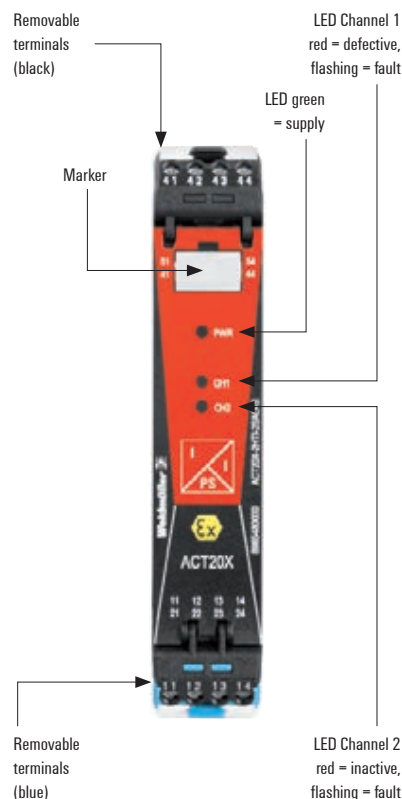
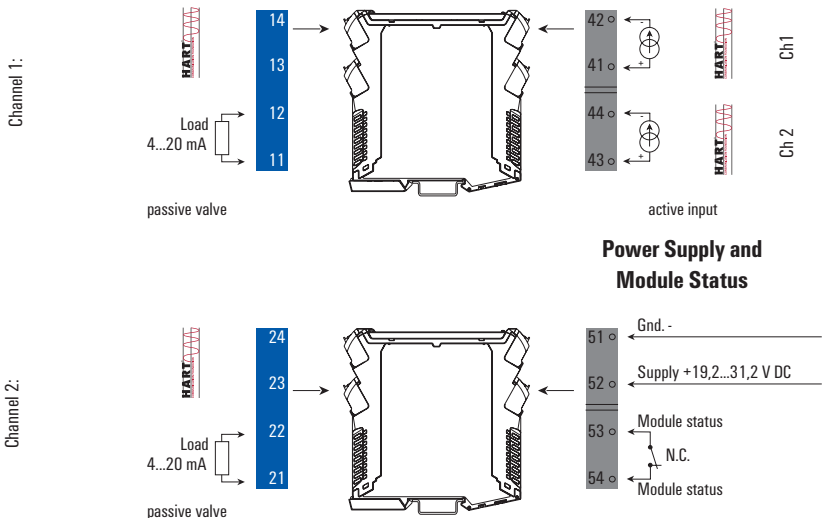

Ex label (excerpt)

ATEX	FM	U_n	28 V
II 3 G Ex nA nC IIC T4 Gc	Installation in CL I DIV2 GP A-D T4	I_n	93 mA
II (1) G [Ex ia Ga] IIC/IIB/IIA	KI. III ABT 1/2 GP A-G or	P_n	0.65 W
II (1) D [Ex ia Da] IIIC	KI. I Zn2 AEx/Ex nA nC [ia] IIC T4	IIC	$C_n = 0.08 \mu F, L_n = 4 \text{ mH}$
IECEx	Example:	IIB	$C_n = 0.65 \mu F, L_n = 16 \text{ mH}$
Ex nA nC IIC T4 Gc	ATEX version,	IIA	$C_n = 2.15 \mu F, L_n = 32 \text{ mH}$
[Ex ia Ga] IIC/IIB/IIA	Ex output,		
[Ex ia Da] IIIC	(More details in ATEX certificate)		



Application example: controlling an actuator in the Ex zone.

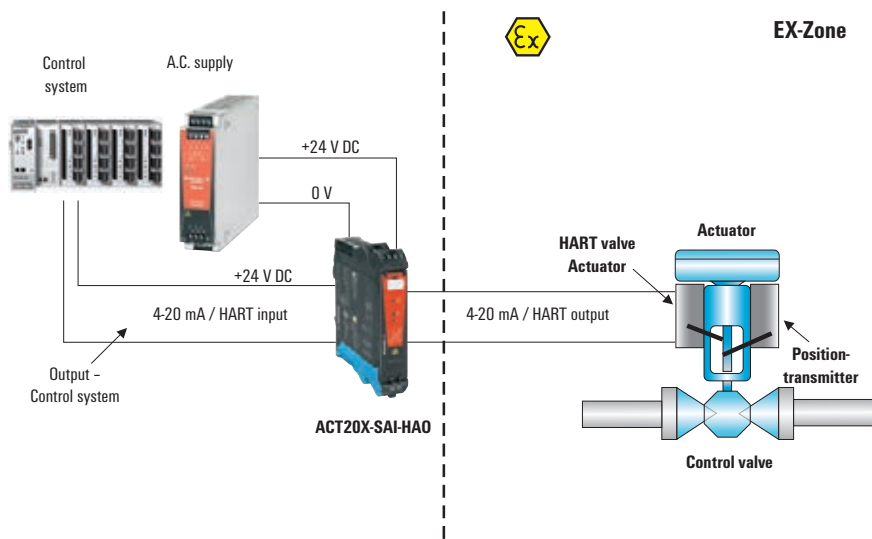

Current output isolator

- For controlling field devices located in explosion risk zones
- HART® Transparent
- Relay output for error alarm
- PC configuration with FDT/DTM software, download at www.weidmueller.com
- 1 or 2 channels in one module

ACT20X-SAI-HA0-S / 2SAI-2HA0-S

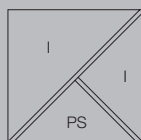

Technical data

Input	
Input current	4...20mA
Voltage drop	< 2 V
Output analogue	
Output current	4...20 mA (max. 23 mA)
Output signal limit	< 28 mA
load impedance current	≤ 600 Ω
2-wire supply	> 14.5 V @ 20 mA
Residual ripple (current loop)	< 7.5 mV _{eff}
Accuracy	< 0.1% span
Temperature coefficient	< 0.01% of span/°C (TU)
Step response time	≤ 5 ms
Cut-off frequency (-3 dB)	0.5...2.5 kHz @ 3.5...23 mA bi-directional HART® signal
Alarm output	
Type	Relay, 1 NC (voltage-free)
Nominal switching voltage	≤ 125 V AC / 110 V DC (safe area) ≤ 32 V AC / 32 V DC (Zone 2)
Continuous current	≤ 0.5 A AC / 0.3 A DC (safe zone), ≤ 0.5 A AC / 1 A DC (Zone 2)
Power rating	≤ 62.5 VA / 32 W (safe area) ≤ 16 VA / 32 W (Zone 2)
General data	
Supply voltage	19.2 - 31.2 V DC
Power consumption	≤ 3 W (2 channels)
Ambient temperature / Storage temperature	-20 °C...+60 °C / -20 °C...+85 °C
Approvals	
Approvals	cULus; DEKRAATEX; DETNORVER; FMEX; GOSTEX; GOSTME25; IECExDEK
Insulation coordination	
Insulation voltage	2.6 kV (input / output)
Rated voltage	300 V
EMC standards	DIN EN 61326

Dimensions	
Clamping range (nominal / min. / max.)	mm ²
Depth x width x height	mm
Note	

Screw connection	
2.5 / 0.5 / 2.5	
113.6 / 22.5 /	

Ordering data

Type	Qty.	Order No.
1-channel version		
ACT20X-SAI-HA0-S	1 ST	8965450000
2-channel version		
ACT20X-2SAI-2HA0-S	1 ST	8965460000

CBX200 USB configuration adapter - 8978580000

ACT20X

Temperature transducer

The ACT20X-HTI-SAO temperature transducer processes temperature signals from PT100 sensors and thermocouples originating in the Ex zone. A current signal (mA) can also be connected as the input signal. The input is part of an intrinsically safe circuit (Zone 0). The isolated milliamp analogue output is the input to the receiver or controller in the safe area. It is available in a single-channel or double-channel version.

EX area Zone 0, 1, 2, 20, 21, 22

Safe area Zone 2 / FM Class 1, Division 2

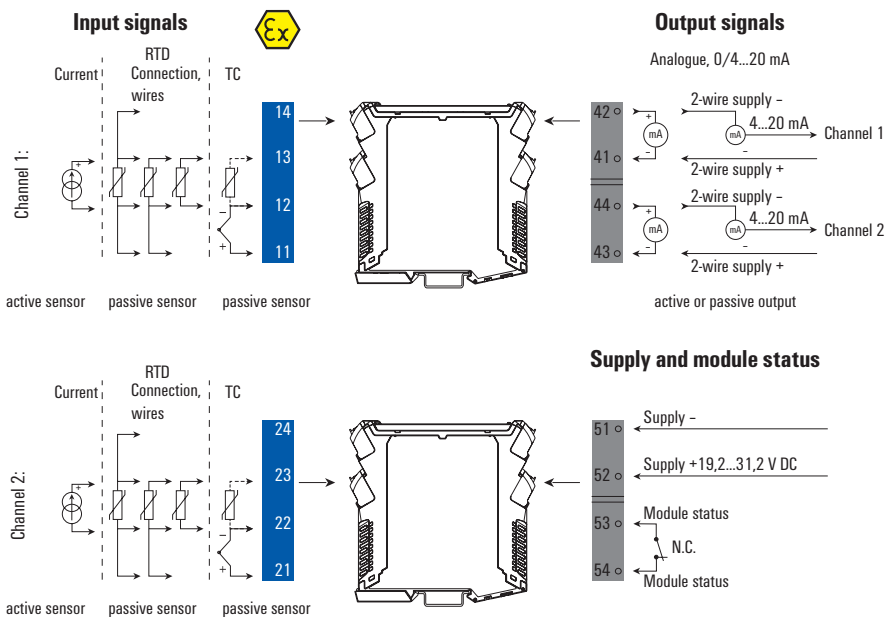

Ex label (excerpt)

ATEX	FM	U_o/U_i	8.7 V / 10 V
II 3 G Ex nA nC IIC T4	Installation in CL I DIV2 GP A-D T4	I_o/I_i	18.4 mA / 30 mA
II (1) G [Ex ia] IIC/IIB/IIA	KI, III ABT 1/2 GP A-G or	P_o	400 mW
II (1) D [Ex iaD]	KI, I Zn2 AEx/Ex nA nC [ia] IIC T4	$L_o/R_o/L_i$	892 μ H/ Ω / 820 nH
	Example:	C_i	30 nF
IECEX	ATEX version,	IIC	$C_o = 5 \mu$ F, $L_o = 100$ mH
Ex nA nC IIC T4 Gc	Ex input Temperature,	IIB	$C_o = 50 \mu$ F, $L_o = 300$ mH
[Ex ia Ga] IIC/IIB/IIA	(More details in ATEX certificate)	IIA	$C_o = 1000 \mu$ F, $L_o = 700$ mH

Application example: temperature measurements in the Ex zone

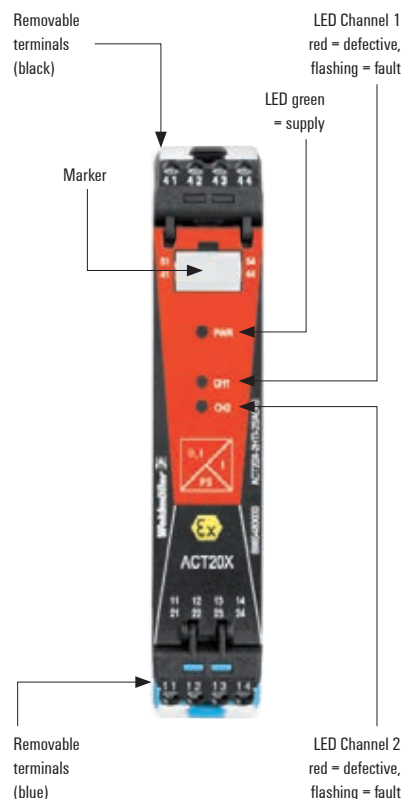
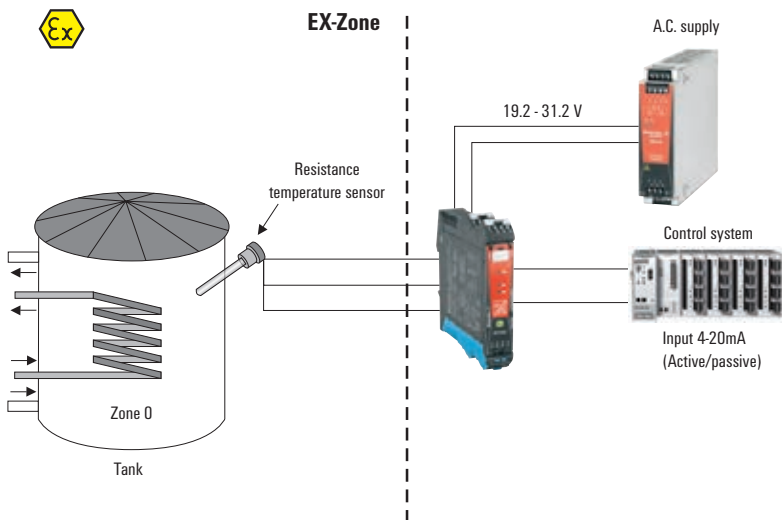

Accuracy / temperature coefficients
ACT20X-HTI-SAO

Input	Accuracy	Temperature coefficient
Input mA	$\leq \pm 4 \mu$ A	$\leq \pm 4 \mu$ A / °C
Input RTD		
Pt100	$\leq \pm 0.2$ °C	$\leq \pm 0.02$ °C / °C
Ni100	$\leq \pm 0.3$ °C	$\leq \pm 0.03$ °C / °C
Input TC		
Type B	$\leq \pm 4.5$ °C	$\leq \pm 0.45$ °C / °C
Type E, J, K, L, N, T, U	$\leq \pm 1$ °C	$\leq \pm 0.1$ °C / °C
Type R, S, W3, W5, LR	$\leq \pm 2$ °C	$\leq \pm 0.2$ °C / °C
Note		

Temperature transducer

- Converts intrinsically safe RTD, thermocouple and mA signals into analogue signals for safe zones.
- PC configuration with FDT/DTM software, download link at www.weidmuller.com
- Relay output for failure alarm
- 1 or 2 channels in one module
- 2-channel module, can also be used as a signal splitter

ACT20X-HTI-2SA0-S / 2HTI-2SA0-S

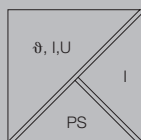

Usable as:

- Safety barrier (insulator)
- Signal conversion
- 2-wire measuring transducer
- Amplifier, repeater

Technical data

Input	
Type	RTD, TC, DC (mA)
Sensor supply	
Temperature input range	Configurable
Line resistance in measuring circuit	≤ 50 Ω
Input current	0...20 mA, 4...20mA
Input resistance, current	20 Ω + PTC 50 Ω
Output	
Output current	0(4)...20 mA / 20...4 mA (configurable)
Output signal limit	3.8...20.5 mA / 0...20.5 mA (dependent on range)
load impedance current	≤ 600 Ω
Influence of load resistance	≤ 0.01% of span / 100 Ω
Current loop output	
Output current (current loop)	4...20 mA
Load resistance	(U _g - 3.5) / 0.023 A
Influence of load resistance	≤ 0.01% of span / 100 Ω
2-wire supply	3.5...26 V DC
Alarm output	
Type	Relay, 1 NC (voltage-free)
Nominal switching voltage	≤ 125 V AC / 110 V DC (safe area) ≤ 32 V AC / 32 V DC (Zone 2)
Continuous current	≤ 0.5 A AC / 0.3 A DC (safe zone), ≤ 0.5 A AC / 1 A DC (Zone 2)
Power rating	≤ 62.5 VA / 32 W (safe area) ≤ 16 VA / 32 W (Zone 2)
General data	
Supply voltage	19.2 - 31.2 V DC
Power consumption	≤ 3 W (2 channels)
Tightening torque, min. / Tightening torque, max.	0.4 Nm / 0.6 Nm
Ambient temperature / Storage temperature	-20 °C...+60 °C / -20 °C...+85 °C
Approvals	
Approvals	cULus; DETNORVER; FMEX; GOSTEX; GOSTME25; IECEXKEM; KEMAATEX
Insulation coordination	
Insulation voltage	2.6 kV (input / output)
Rated voltage	300 V
EMC standards	DIN EN 61326
Dimensions	
Clamping range (nominal / min. / max.)	mm ²
Length x width x height	mm
Note	
Screw connection	
	2.5 / 0.5 / 2.5
	119.2 / 22.5 /

Type	Temperature-range	Accuracy
Metal PTC		
Pt100	-200...850 °C	± (0.15 + 0.02 x T) Class A ± (0.30 °C + 0.005 x T) Class B
Pt500	-200...850 °C	
Pt1000	-200...850 °C	
Ni50		
Ni100	-60...0 °C	± (0.4 + 0.007 x T)
Ni120	0...180 °C	± (0.4 + 0.028 x T)
Ni1000		
TC-Type according to IEC60584-1		
B	50...250 °C	± 25 K
	250...500 °C	± 10 K
	500...1820 °C	± 6 K
E	-200...-150 °C	± 4 K
	-150...1000 °C	± 3 K
J	-200...-150 °C	± 4 K
	-150...1200 °C	± 3 K
K	-200...-150 °C	± 5 K
	-150...1200 °C	± 3 K
	1200...1372 °C	± 4 K
N	-200...-150 °C	± 6 K
	-150...1300 °C	± 3 K
R	-50...200 °C	± 10 K
	200...1780 °C	± 6 K
S	-50...200 °C	± 10 K
	200...1780 °C	± 6 K
T	-200...-150 °C	± 5 K
	-150...400 °C	± 3 K
according to DIN43710		
U	0...600 °C	± 3 °C
L	0...900 °C	± 3 °C

Ordering data

Type	Qty.	Order No.
1-channel version		
ACT20X-HTI-2SA0-S	1 ST	8965470000
2-channel version		
ACT20X-2HTI-2SA0-S	1 ST	8965480000

CBX200 USB configuration adapter - 8978580000

ACT20X

Universal measurement and signal isolator-converter

The ACT20X-HUI-SA0-S is a universal input signal isolator/converter. This model processes temperature signals from PT100 sensors and thermocouples as well as DC voltage and current signals (mA) from the hazardous area. On the output side, an isolated milliamp signal is passed to the receiver or controller in the safe area. This model also has a relay output which can be used for a process alarm or trip.

EX area Zone 0, 1, 2, 20, 21, 22

Safe area Zone 2 / FM Class 1, Division 2

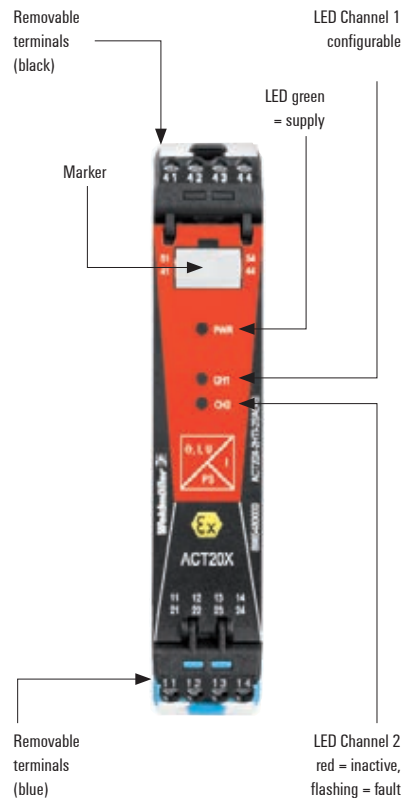
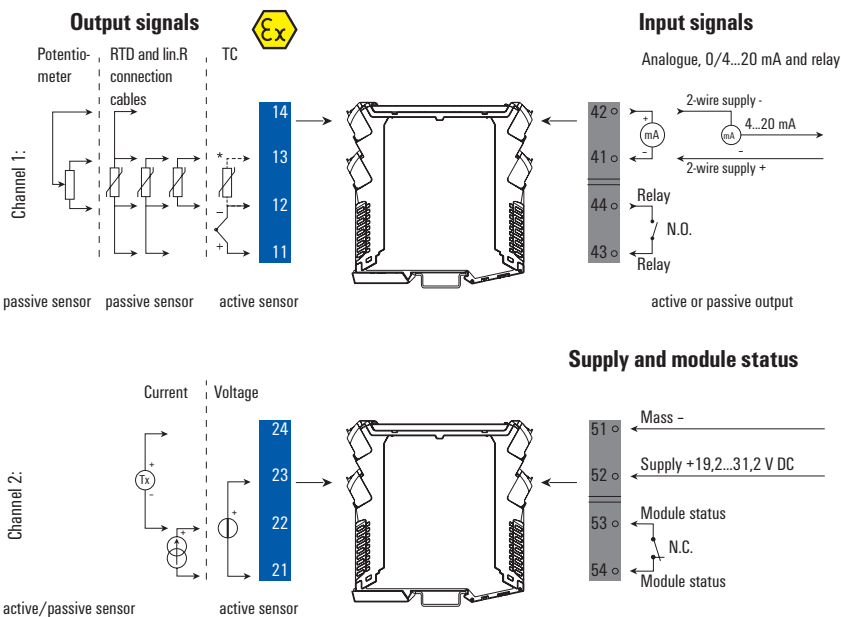

Ex label (excerpt)

ATEX	FM	U_i / U_o	30 V / 8.3 V
II 3 G Ex nA nC IIC T4	Installation in CL I DIV2 GP A-D T4	I_i / I_o	120 mA / 0.2 mA
II (1) G [Ex ia] IIC/IIB/IIA	KI, III ABT 1/2 GP A-G or	P./P _o	900 mW / 0.4 mW
II (1) D [Ex iaD]	KI, I Zn2 AEx/Ex nA nC [ia] IIC T4	C_i	3 nF
IECEX	Example:	L_i	1 µH
Ex nA nC IIC T4 Gc	ATEX version,	IIC	$C_o = 7 \mu F$ $L_o = 1000 \text{ mH}$
[Ex ia Ga] IIC/IIB/IIA	Ex input External Current Source	IIB	$C_o = 73 \mu F$ $L_o = 1000 \text{ mH}$
[Ex ia a] IIC	(More details in ATEX certificate)	IIA	$C_o = 1000 \mu F$ $L_o = 1000 \text{ mH}$



Application example: position measurement of an actuator

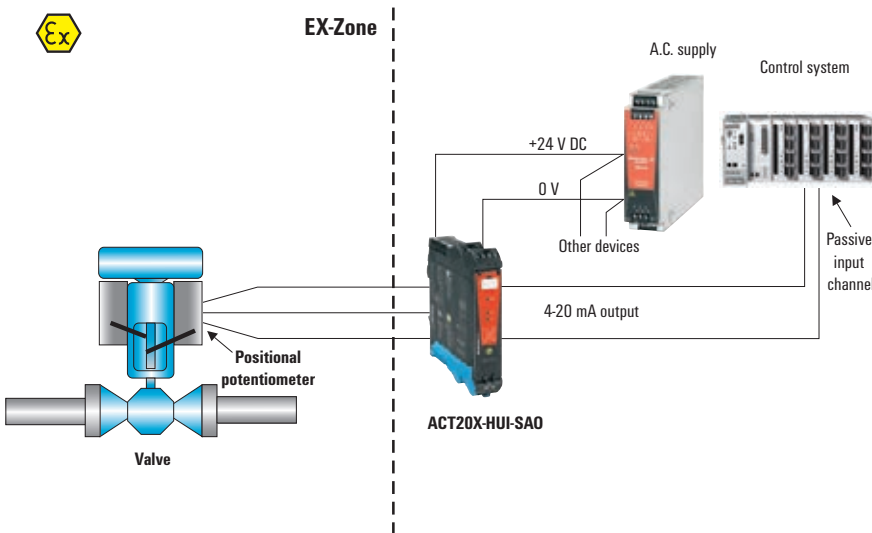

Accuracy / temperature coefficients ACT20X-HUI-SA0

Input	Accuracy	Temperature coefficient
Input mA	$\leq \pm 4 \mu A$	$\leq \pm 4 \mu A / ^\circ C$
Input Volt	$\leq \pm 20 \mu V$	$\leq \pm 2 \mu V / ^\circ C$
Input RTD		
Pt100	$\leq \pm 0.2 ^\circ C$	$\leq \pm 0.02 ^\circ C / ^\circ C$
Ni100	$\leq \pm 0.3 ^\circ C$	$\leq \pm 0.03 ^\circ C / ^\circ C$
Input TC		
Type B	$\leq \pm 4.5 ^\circ C$	$\leq \pm 0.45 ^\circ C / ^\circ C$
Type E, J, K, L, N, T, U	$\leq \pm 1 ^\circ C$	$\leq \pm 0.1 ^\circ C / ^\circ C$
Type R, S, W3, W5, LR	$\leq \pm 2 ^\circ C$	$\leq \pm 0.2 ^\circ C / ^\circ C$
Note		

Universal measurement and signal isolator converter

- Universal isolator for intrinsically safe RTD signals, thermal sensor signals, resistor signals, potentiometer signals and DC signals (mA,V)
- PC configuration with FDT/DTM software, download at www.weidmueller.com
- Digital relay output adjustable as threshold switch
- Relay output for error alarm

ACT20X-HUI-SA0-S

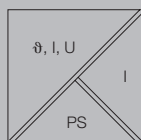

Usable as:

- Safety barrier (insulator)
- Signal conversion
- 2-wire measuring transducer
- Amplifier, repeater

Technical data

Input	
Type	RTD, TC, DC (mA, V)
Sensor supply	28...16.5 V DC/0...20 mA
Temperature input range	Configurable
Line resistance in measuring circuit	≤ 50 Ω
Input current	0...20 mA, 4...20mA
Input voltage	0...12 V DC, configurable: 0.1 / 0.2...1 / 0.5 / 0...10 and 2...10 V DC
Potentiometer	10 Ω...10 kΩ
Input resistance, voltage/current	> 10 MΩ / 20 Ω + PTC 50 Ω
Output analogue	
Output current	0...23 mA, configurable: 0...20 / 4...20 / 20...0 / 20...4 mA
Output signal limit	3.8...20.5 mA / 0...20.5 mA (dependent on range)
load impedance current	≤ 600 Ω
Influence of load resistance	≤ 0.01% of span / 100 Ω
Current loop output	
Output current (current loop)	4...20 mA
Load resistance	≤ (Vs - 10) / 20 mA (current loop)
Influence of load resistance	≤ 0.01% of span / 100 Ω
2-wire supply	≤ 26 V DC
Output digital	
Type	Relay, 1 NO / NC contact
Function	Configurable switching thresholds, Sensor error, Window function
Nominal switching voltage	≤ 250 V AC / 30 V DC (safe area) ≤ 32 V AC / 32 V DC (Zone 2) ≤ 2 A AC/DC (safe area, Zone 2 area)
Continuous current	≤ 2 A AC/DC (safe area, Zone 2 area)
Alarm output	
Type	Relay, 1 NC (voltage-free)
Nominal switching voltage	≤ 125 V AC / 110 V DC (safe area) ≤ 32 V AC / 32 V DC (Zone 2)
Continuous current	≤ 0.5 A AC / 0.3 A DC (safe zone), ≤ 0.5 A AC / 1 A DC (Zone 2)
General data	
Supply voltage	19.2 - 31.2 V DC
Power consumption	≤ 3.5 W
Tightening torque, min. / Tightening torque, max.	0.4 Nm / 0.6 Nm
Ambient temperature / Storage temperature	-20 °C...+60 °C / -20 °C...+85 °C
Approvals	
Approvals	cULus; DETNORVER; FMEX; GOSTEX; GOSTME25; IECEXKEM; KEMAATEX
Insulation coordination	
Insulation voltage / Rated voltage	2.6 kV (input / output) / 300 V
EMC standards	DIN EN 61326
Dimensions	
Clamping range (nominal / min. / max.)	mm ²
Length x width x height	mm
Note	
Screw connection	
	2.5 / 0.5 / 2.5
	119.2 / 22.5 /

Type	Temperature-range	Accuracy
Metal PTC		
Pt100	-200...850 °C	± (0.15 + 0.02 x T) Class A ± (0.30 °C + 0.005 x T) Class B
Pt500	-200...850 °C	
Pt1000	-200...850 °C	
Ni50		± (0.4 + 0.007 x T) ± (0.4 + 0.028 x T)
Ni100	-60...0 °C	
Ni120	0...180 °C	
Ni1000		
TC-Type according to IEC60584-1		
B	50...250 °C	± 25 K
	250...500 °C	± 10 K
	500...1820 °C	± 6 K
E	-200...-150 °C	± 4 K
	-150...1000 °C	± 3 K
J	-200...-150 °C	± 4 K
	-150...1200 °C	± 3 K
K	-200...-150 °C	± 5 K
	-150...1200 °C	± 3 K
	1200...1372 °C	± 4 K
	-200...-150 °C	± 6 K
R	-150...1300 °C	± 3 K
	-50...200 °C	± 10 K
S	200...1780 °C	± 6 K
	-50...200 °C	± 10 K
T	200...1780 °C	± 6 K
	-200...-150 °C	± 5 K
	-150...400 °C	± 3 K
according to DIN43710		
U	0...600 °C	± 3 °C
L	0...900 °C	± 3 °C

Ordering data

Type	Qty.	Order No.
1-channel version		
ACT20X-HUI-SA0-S	1 ST	8965490000

CBX200 USB configuration adapter - 8978580000

ACT20X

Output loop powered universal measurement and signal isolating converter

The ACT20X-HUI-SA0-LP is a universal input, isolating signal converter. This model processes temperature signals from PT100 sensors and thermocouples as well as DC voltage and current signals (mA) from the hazardous area. The 12.5 mm wide module is powered through it's 4-20 mA output.

EX area Zone 0, 1, 2, 20, 21, 22

Safe area Zone 2 / FM Class 1, Division 2

B

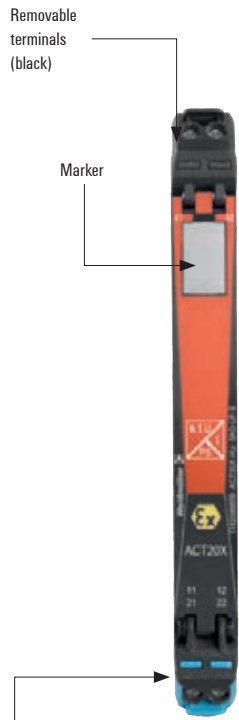
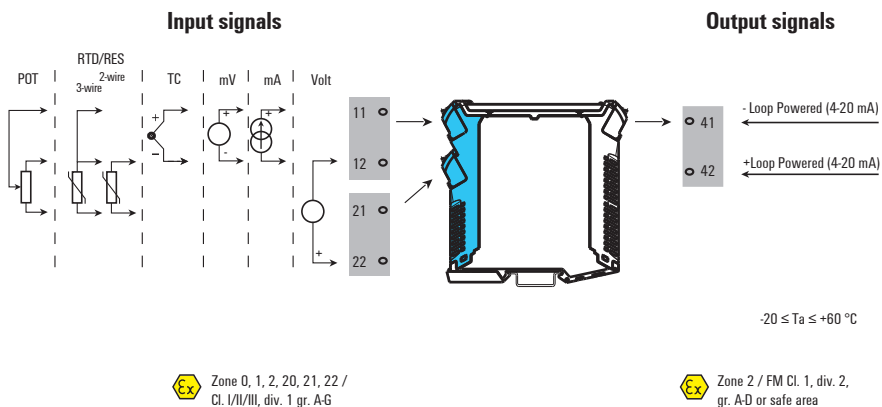

Removable terminals (black)
Marker
Removable terminals (blue)



Ex label

ATEX		U_o	5.88 V
II 3 G Ex nA nC IIC T4		I_o	3.1 mA
II (1) G [Ex ia] IIC/IIB/IIA		P_o	4.6 mW
II (1) D [Ex iaD]		C_i	0.001 μ F
IECEx		L_i	negligible
Ex nA IIC T4 Gc	Example:		
[Ex ia Ma Ga] I/IIC [Ex ia Da] IIC	IECEx version		
	(More details in IECEx certificate)		

Application example: Temperature measurement in the EX-zone

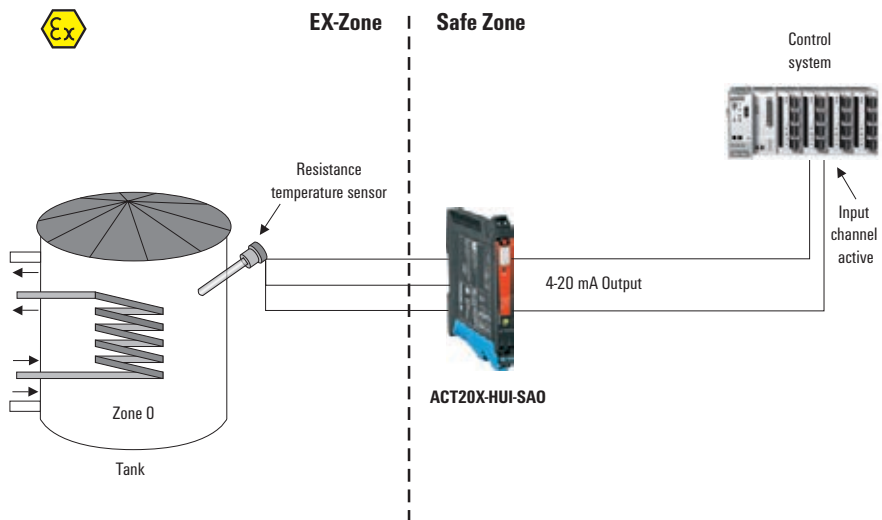

Accuracy / temperature coefficients ACT20X-HUI-SA0-LP

Input	Accuracy	Temperature coefficient
Input mA	$\leq \pm 4 \mu$ A	$\leq \pm 4 \mu$ A / °C
Input Volt	$\leq \pm 20 \mu$ V	$\leq \pm 2 \mu$ V / °C
Input RTD		
Pt100	$\leq \pm 0.2$ °C	$\leq \pm 0.02$ °C / °C
Ni100	$\leq \pm 0.3$ °C	$\leq \pm 0.03$ °C / °C
Input TC		
Type B	$\leq \pm 4.5$ °C	$\leq \pm 0.45$ °C / °C
Type E, J, K, L, N, T, U	$\leq \pm 1$ °C	$\leq \pm 0.1$ °C / °C
Type R, S, W3, W5, LR	$\leq \pm 2$ °C	$\leq \pm 0.2$ °C / °C
Note		

Universal measurement and signal isolator-converter

Output-loop powered

- Universal isolator for intrinsically safe RTD signals, thermal sensor signals, resistor signals, potentiometer signals and DC signals (mA,V)
- Supply via output loop
- 12.5 mm thin housing
- PC configuration with FDT/DTM software, download at www.weidmuller.com

ACT20X-HUI-SA0-LP-S

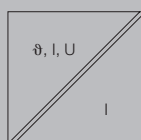

Technical data

Input	
Type	RTD, TC, DC (mA, V), 2- 3 wire resistor
Temperature input range	Configurable
Input current	± 25 mA
Input voltage	± 28 V DC
Potentiometer	10 Ω...10 kΩ
Input resistance, voltage/current	> 10 MΩ @ 600 mV, 2 MΩ @ 28 V / 70 Ω
Output analogue	
Output current	4...20 mA (max. 23 mA)
load impedance current	≤ 700 Ω
Residual ripple (current loop)	≤ 10 mV _{ss}
Accuracy	< 0.1 % of end value
Temperature coefficient	Max. 200 ppm/K of output range
Step response time	< 400 ms (10...90 %)
Cut-off frequency (-3 dB)	100 Hz
General data	
Supply voltage	11...28 V DC (loop powered)
Tightening torque, min. / Tightening torque, max.	0.4 Nm / 0.6 Nm
Ambient temperature / Storage temperature	0 °C...+60 °C / -20 °C...+70 °C
Approvals	
Approvals	cULus; GOSTEX
Insulation coordination	
Insulation voltage / Rated voltage	4 kV (input / output) / 300 V _{eff}
Rated voltage	300 V _{eff}
EMC standards	DIN EN 61326

Dimensions	
Clamping range (nominal / min. / max.)	mm ²
Length x width x height	mm
Note	

Screw connection	
	2.5 / 0.5 / 2.5
	119.2 / 12.5 /

Inputs					
Type	Thermocouples (TC), RTD, mA, Volt, mV, resistor, potentiometer				
Type	Standard	Lower limit	Upper limit	Min. area	
B		100 °C	1820 °C	400 °C	
E	IEC584	-270 °C	1000 °C	80 °C	
J		-270 °C	1200 °C		
K		-270 °C	1372 °C		
L	DIN43710	-100 °C	900 °C		
N	IEC584	-180 °C	1300 °C	100 °C	100 °C
R, S		-50 °C	1768 °C	300 °C	80 °C
T		-270 °C	400 °C	400 °C	80 °C
U	DIN43710	-200 °C	600 °C	100 °C	100 °C
User-defined Input		Up to 101 values			
Error detection		Upper error signalling value: 23 mA, Lower error signalling value: 3,5 mA			
mA		±25 mA @ 70 Ω		4 mA	
Volt		±28 V @ 2 MΩ		2,0 V	
		±12 V @ 2 MΩ		1,0 V	
mV		±600 mV @ >10 MΩ		50 mV	
		±150 mV @ >10 MΩ		15 mV	
Type	Standard	Lower limit	Upper limit	Min. area	
2-, 3-, 4-wire RTD	Pt100,	DIN43710	-200 °C	850 °C	-20 °C
	Pt200				
	Pt1000				
	Ni120	-80 °C	320 °C	15 °C	
	Cu10	-100 °C	260 °C	100 °C	
User-defined Input		Up to 101 values			
Resistance		0 to 12 kΩ / 500 Ω			
		0 to 15 kΩ / 100 Ω			
		0 to 750 Ω / 50 Ω			
Potentiometer		1.2 kΩ to 500 kΩ			

Ordering data

Type	Qty.	Order No.
1-channel version		
ACT20X-HUI-SA0-LP-S	1 ST	1318220000

CBX200 USB configuration adapter - 8978580000

ACT20X

NAMUR isolating switching amplifier: with relay output

The ACT20X-HDI-SDO-RNO (NC) isolating switching amplifier is a specialised signal isolating converter for Namur sensor signals or for volt-free contacts from a Zone 0 hazardous area. A single relay, available optionally as NC or NO, provides the output signal in the safe zone. Single-channel or double-channel versions are also available.

EX area Zone 0, 1, 2, 20, 21, 22

Safe area Zone 2 / FM Class 1, Division 2

B

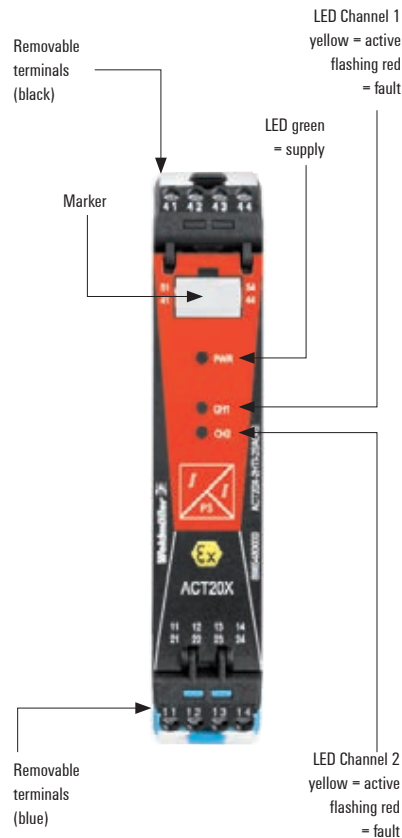
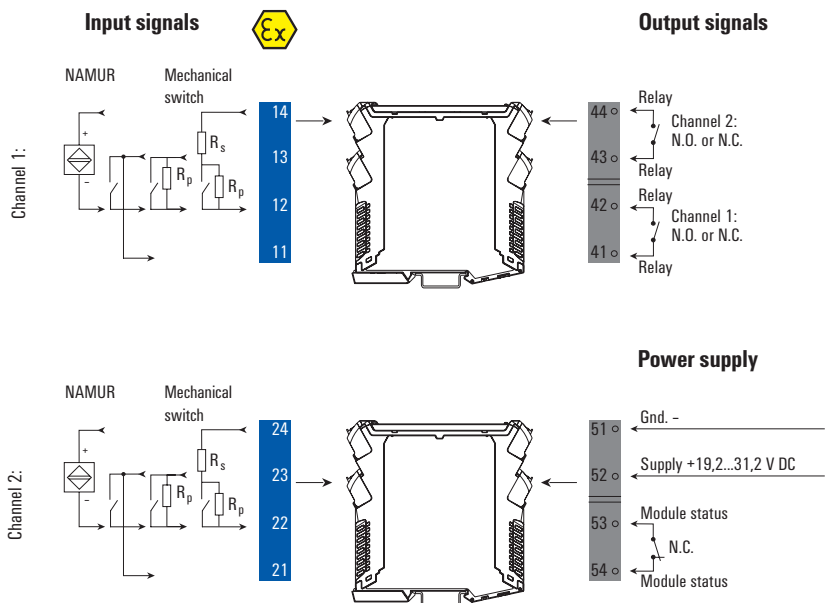

Ex label (excerpt)

ATEX	FM	U_o	10.6 V
II 3 G Ex nA nC IIC T4	Installation in CL I DIV2 GP A-D T4	I_o	12 mA
II (1) G [Ex ia Ga] IIC/IIB/IIA	KI. III ABT 1/2 GP A-G oder	P_o	32 mW
II (1) D [Ex iaD]	KI. I Zn2 AEx/Ex nA nC [ia] IIC T4	L_s / R_s	1150 μ H/ Ω
IECEX	Example:	IIC	$C_o = 2 \mu$ F, $L_s = 260$ mH
Ex nA nC IIC T4 Gc	ATEX version,	IIB	$C_o = 6 \mu$ F, $L_s = 780$ mH
[Ex ia Ga] IIC/IIB/IIA	Ex input	IIA	$C_o = 18 \mu$ F, $L_s = 1000$ mH
[Ex ia Da] IIIC	(More details in ATEX certificate)		



Application: monitoring of fill level with the ACT20X HDI-SDO-RNO (relay output)

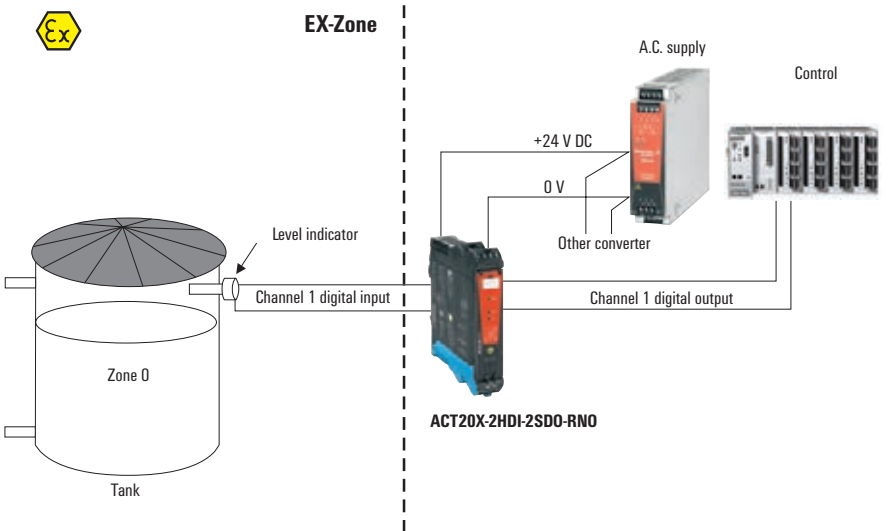

NAMUR isolating switching amplifier

- Converts intrinsically safe digital signals (NAMUR / switching contact) from EX Zone 0 into digital output signals (relay output) for the safe zone
- PC configuration with FDT/DTM software, download at www.weidmueller.com
- Relay output for error alarm, cable break, short-circuit
- 1 or 2 channels in one module

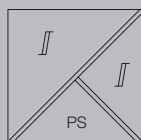
ACT20X-HDI-SDO-RNO-S / RNC-S
ACT20X-2HDI-2SDO-RNO-S / RNC-S
**Technical data**

Input	
Sensor	NAMUR sensor, according to EN60947, switch with or without RS, RP
Sensor supply	8 V DC / 8 mA
Resistance	RP = 750 Ω / RS = 15kΩ
Input frequency	0...5 kHz
Pulse duration	> 0.1 ms
Input resistance	1 kΩ
Trigger level low / Trigger level high	< 1.2 mA / > 2.1 mA
Output signal in case of wire break	< 0.1 mA, > 6.5 mA (in case of wire break)
Output	
Type	Relay, 2 NC (voltage-free), Switching frequency 20 Hz
Rated switching voltage	≤ 250 V AC / 30 V DC (safe area) ≤ 32 V AC / 32 V DC (Zone 2)
Continuous current	≤ 2 A AC/DC (safe area, Zone 2 area)
Power rating	≤ 500 VA / 60 W (safe area) ≤ 16 VA / 32 W (Zone 2)
Alarm output	
Type	Relay, 1 NC (voltage-free)
Nominal switching voltage	≤ 125 V AC / 110 V DC (safe area) ≤ 32 V AC / 32 V DC (Zone 2)
Continuous current	≤ 0.5 A AC / 0.3 A DC (safe zone), ≤ 0.5 A AC / 1 A DC (Zone 2)
Power rating	≤ 62.5 VA / 32 W (safe area) ≤ 16 VA / 32 W (Zone 2)
General data	
Supply voltage	19.2 - 31.2 V DC
NAMUR supply	8 V DC / 8 mA
Power consumption	≤ 3 W (2 channels)
Tightening torque, min. / Tightening torque, max.	0.4 Nm / 0.6 Nm
Ambient temperature / Storage temperature	-20 °C...+60 °C / -20 °C...+85 °C
Approvals	
Approvals	cULus; DETNORVER; FMEX; GOSTEX; GOSTME25; IECEXKEM; KEMAATEX
Insulation coordination	
Insulation voltage	2.6 kV (input / output)
Rated voltage	300 V
EMC standards	DIN EN 61326
Dimensions	
Clamping range (nominal / min. / max.)	mm ²
Length x width x height	mm
Note	
Screw connection	
	2.5 / 0.5 / 2.5
	119.2 / 22.5 /

Ordering data

Type	Qty.	Order No.
1-channel version, NO		
ACT20X-HDI-SDO-RNO-S	1 ST	8965340000
1-channel version, NC		
ACT20X-HDI-SDO-RNC-S	1 ST	8965350000
2-channel version, NO		
ACT20X-2HDI-2SDO-RNO-S	1 ST	8965370000
2-channel version, NC		
ACT20X-2HDI-2SDO-RNC-S	1 ST	8965380000
CBX200 USB configuration adapter - 8978580000		

ACT20X

Pulse Isolator, with NPN transistor output.

The ACT20X-HDI-SDO isolating switching amplifier is a digital pulse signal isolator for Namur sensors or volt-free contacts from a Zone 0 hazardous area. A transistor (NPN) output is provided for the receiver or controller in the safe area. Single-channel or double-channel versions are also available.

EX area Zone 0, 1, 2, 20, 21, 22

Safe area Zone 2 / FM Class 1, Division 2

B

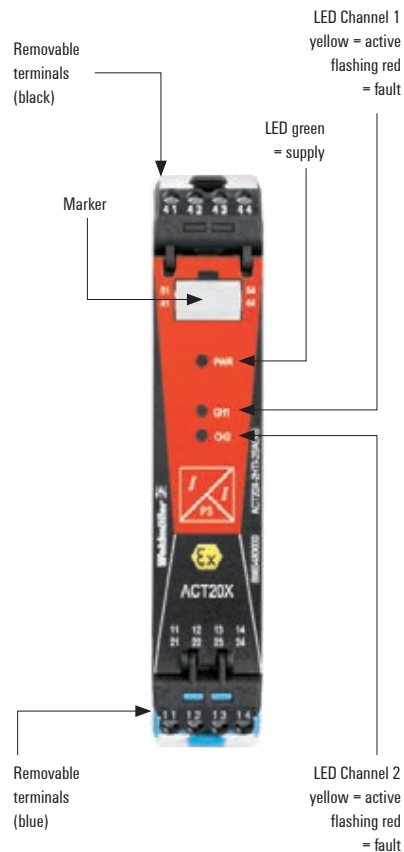
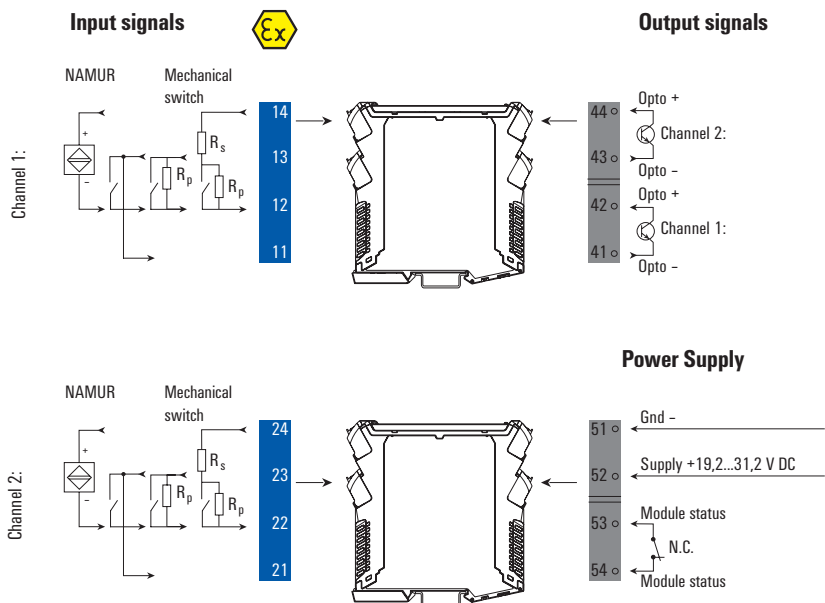

Ex label (excerpt)

ATEX	FM	U_o	10.6 V
II 3 G Ex nA nC IIC T4	Installation in CL I DIV2 GP A-D T4	I_o	12 mA
II (1) G [Ex ia Ga] IIC/IIB/IIA	KI. III ABT 1/2 GP A-G oder	P_o	32 mW
II (1) D [Ex iaD]	KI. I Zn2 AEx/Ex nA nC [ia] IIC T4	L_s / R_s	1150 μ H/ Ω
IECEX	Example:	IIC	$C_o = 2 \mu$ F, $L_s = 260$ mH
Ex nA nC IIC T4 Gc	ATEX version	IIB	$C_o = 6 \mu$ F, $L_s = 780$ mH
[Ex ia Ga] IIC/IIB/IIA	Ex input	IIA	$C_o = 18 \mu$ F, $L_s = 1000$ mH
[Ex ia Da] IIIC	(More details in ATEX certificate)		



Application: monitoring the fill level with isolating switching amplifier

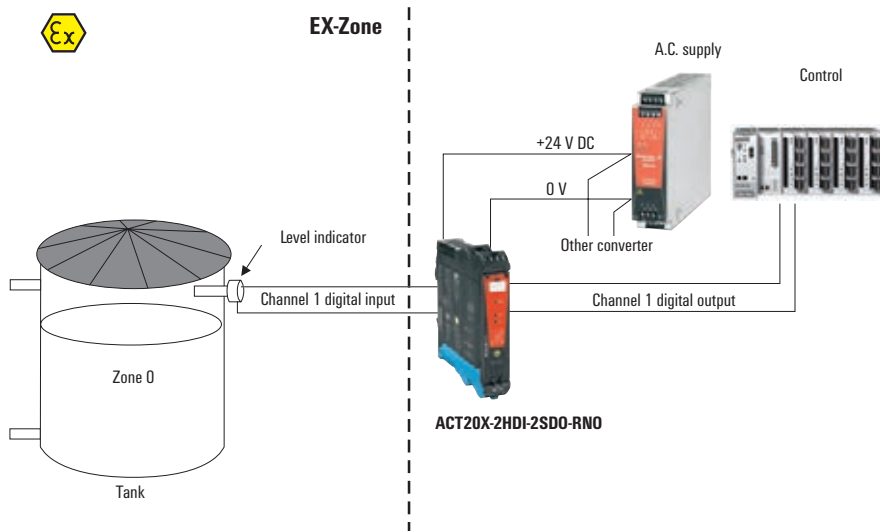

NAMUR isolating switching amplifier

- Converts intrinsically safe signals (NAMUR / switching contact) from EX Zone 0 into digital output signals (relay output) for the safe zone
- PC configuration with FDT/DTM software, download at www.weidmueller.com
- Relay output for error alarm
- 1 or 2 channels in one module

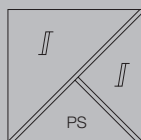
ACT20X-HDI-SD0-S / 2HDI-2SD0-S**Technical data**

Input	
Sensor	NAMUR sensor, according to EN60947, switch with or without RS, RP
Sensor supply	8 V DC / 8 mA
Resistance	Parallel resistor 15kΩ, Series resistor 750Ω
Input frequency	0...5 kHz
Pulse duration	> 0.1 ms
Input resistance	1 kΩ
Trigger level low / Trigger level high	< 1.2 mA / > 2.1 mA
Output signal in case of wire break	< 0.1 mA, > 6.5 mA (in case of wire break)
Output	
Type	NPN transistor output
Switching frequency	5 kHz
Pulse duration	> 0.1 ms
Rated switching voltage	≤ 30 V DC
Power rating	≤ 80 mA / ≤ 2.4 W
Voltage drop at max. load	< 2.5 V DC
Alarm output	
Type	Relay, 1 NC (voltage-free)
Nominal switching voltage	≤ 125 V AC / 110 V DC (safe area) ≤ 32 V AC / 32 V DC (Zone 2)
Continuous current	≤ 0.5 A AC / 0.3 A DC (safe zone), ≤ 0.5 A AC / 1 A DC (Zone 2)
Power rating	≤ 62.5 VA / 32 W (safe area) ≤ 16 VA / 32 W (Zone 2)
General data	
Power consumption	≤ 3 W (2 channels)
Supply voltage	19.2 - 31.2 V DC
NAMUR supply	8 V DC / 8 mA
Power consumption	≤ 3 W (2 channels)
Tightening torque, min. / Tightening torque, max.	0.4 Nm / 0.6 Nm
Ambient temperature / Storage temperature	-20 °C...+60 °C / -20 °C...+85 °C
Approvals	
Approvals	cULus; DETNORVER; FMEX; GOSTEX; GOSTME25; IECEXKEM; KEMAATEX
Insulation coordination	
Insulation voltage	2.6 kV (input / output)
Rated voltage	300 V
EMC standards	DIN EN 61326
Dimensions	
Clamping range (nominal / min. / max.)	mm ²
Length x width x height	mm
Note	
Screw connection	
	2.5 / 0.5 / 2.5
	119.2 / 22.5 /

Ordering data

Type	Qty.	Order No.
1-channel version		
ACT20X-HDI-SD0-S	1 ST	8965360000
2-channel version		
ACT20X-2HDI-2SD0-S	1 ST	8965390000

CBX200 USB configuration adapter - 8978580000

ACT20X

Valve control component for gas group IIC, 35 mA

The ACT20X-SDI-HAO-S solenoid/actuator driver takes a switched input from e.g. a safe area controller and delivers an corresponding output to operate an actuator in a hazardous area, e.g. Zone 0. It is available in a single-channel or double-channel version.

EX area Zone 0, 1, 2, 20, 21, 22

Save area Zone 2 /FM KI. 1 Abt. 2

Ex-Output Signals



Input signals

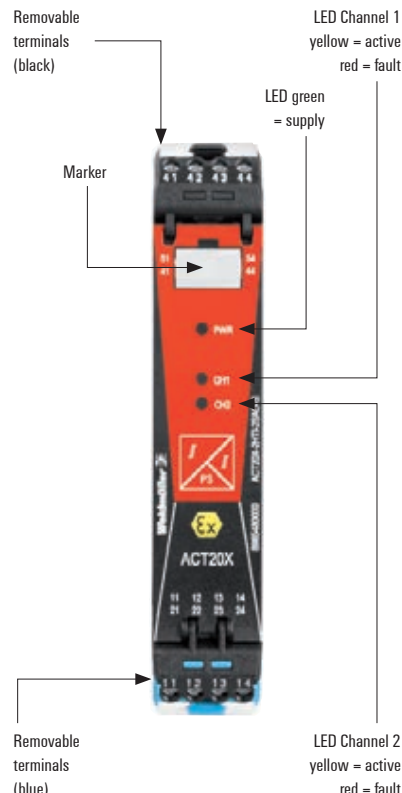
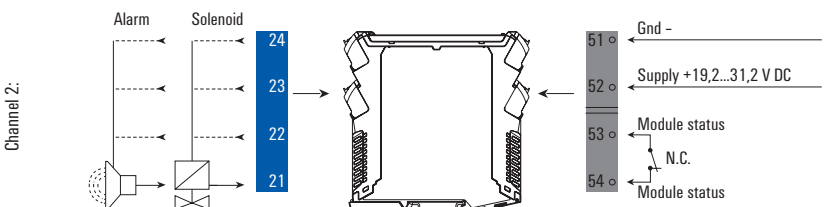
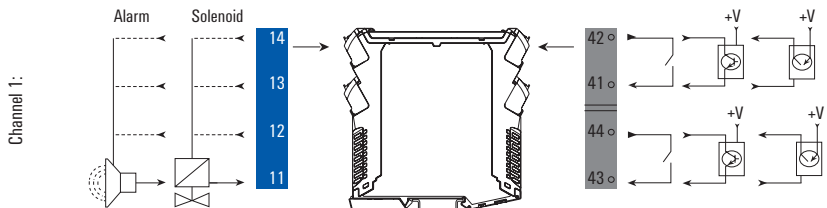

Ex label (excerpt)

ATEX	FM	U_n	28 V
II 3 G Ex nA nC IIC T4	Installation in CL I DIV2 GP A-D T4	I_b	100 mA
II (1) G [Ex ia Ga] IIC/IIB/IIA	KI. III ABT 1/2 GP A-G oder	P_o	0.70 mW
II (1) D [Ex iaD]	KI. I Zn2 AEx/Ex nA nC [ia] IIC T4	IIC	$C_o = 0.08 \mu F, L_o = 2.9 mH$
IECEX	Example:	IIB	$C_o = 0.64 \mu F, L_o = 12.8 mH$
Ex nA nC IIC T4 Gc	ATEX version	IIA	$C_o = 2.1 \mu F, L_o = 22.8 mH$
[Ex ia Ga] IIC/IIB/IIA	Ex Output Terminal (11-14)		
[Ex ia Da] IIIC	(More details in ATEX certificate)		

Application: Inflow control in Ex zone with gas group IIC

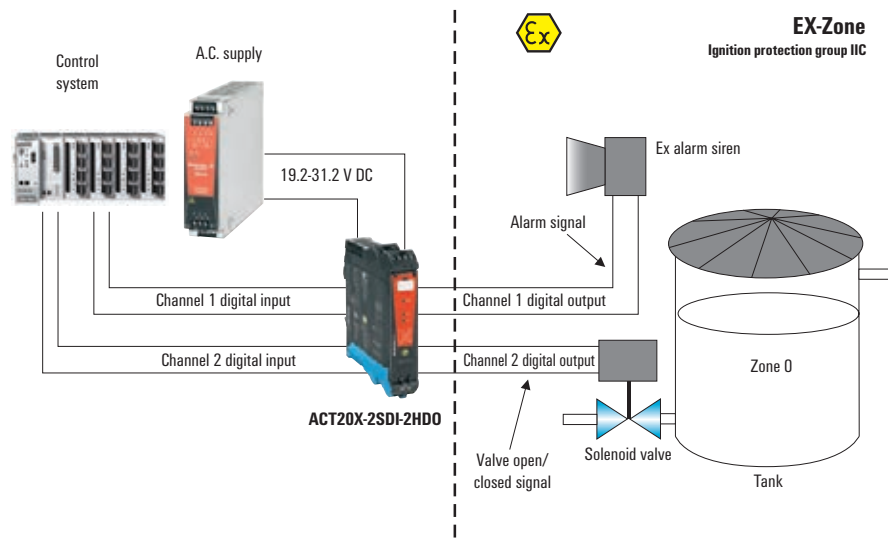

Output data

For gas group IIC (≤ 35 mA)

Connection terminal			
Channel 1	U without load	U with load	I max
11-12	Min. 24 V	Min. 12.5 V	35 mA
11-13	Min. 24 V	Min. 13.5 V	35 mA
11-14	Min. 24 V	Min. 14.5 V	35 mA
Note			

For gas group IIC (≤ 35 mA)

Connection terminal			
Channel 2	U without load	U with load	I max
21-22	Min. 24 V	Min. 12.5 V	35 mA
21-23	Min. 24 V	Min. 13.5 V	35 mA
21-24	Min. 24 V	Min. 14.5 V	35 mA
Note			

Valve control module

- Valve control component for control of intrinsically safe valves, LEDs, acoustic alarms, etc.
- PC configuration with FDT/DTM software, download at www.weidmueller.com
- Output current is limited to 35 mA for ignition group IIC
- 1 or 2 channels in one module
- Relay output for error alarm

ACT20X-SDI-HDO / 2SDI-2HDO

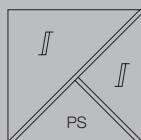

Technical data

Input	
Type	NPN, PNP switching signal
Input voltage	≤ 28 V DC
Input resistance, voltage	3.5 kΩ
Trigger level low	≤ 2.0 V DC (NPN), ≤ 8.0 V DC (PNP)
Trigger level high	≥ 4.0 V DC (NPN), ≥ 10V DC (PNP)
Alarm output	
Type	Relay, 1 NC (voltage-free)
Nominal switching voltage	≤ 125 V AC / 110 V DC (safe area) ≤ 32 V AC / 32 V DC (Zone 2)
Continuous current	≤ 0.5 A AC / 0.3 A DC (safe zone), ≤ 0.5 A AC / 1 A DC (Zone 2)
Power rating	≤ 62.5 VA / 32 W (safe area) ≤ 16 VA / 32 W (Zone 2)
General data	
Supply voltage	19.2 - 31.2 V DC
Power consumption	≤ 3.5 W (with 2 channels)
Tightening torque, min. / Tightening torque, max.	0.4 Nm / 0.6 Nm
Ambient temperature / Storage temperature	-20 °C...+60 °C / -20 °C...+85 °C
Approvals	
Approvals	cULus; DETNORVER; FMEX; GOSTEX; GOSTME25; IECEXKEM; KEMAATEX
Insulation coordination	
Insulation voltage	2.6 kV (input / output)
Rated voltage	300 V
EMC standards	DIN EN 61326

Dimensions	
Clamping range (nominal / min. / max.)	mm ²
Length x width x height	mm
Note	

Screw connection	
	2.5 / 0.5 / 2.5
	119.2 / 22.5 /

Ordering data

Type	Qty.	Order No.
1-channel version		
ACT20X-SDI-HDO-L-S	1 ST	8965400000
2-channel version		
ACT20X-2SDI-2HDO-S	1 ST	8965420000

CBX200 USB configuration adapter - 8978580000

ACT20X

Valve control component for gas group IIB, 60 mA

The ACT20X-SDI-HAO-S solenoid/actuator driver takes a switched input from e.g. a safe area controller and delivers an corresponding output to operate an actuator in a hazardous area, e.g. Zone. This driver is suitable for switching solenoid valves or alarm devices.

EX area Zone 0, 1, 2, 20, 21, 22

Safe area Zone 2 / FM Class 1, Division 2

Ex Output Signals

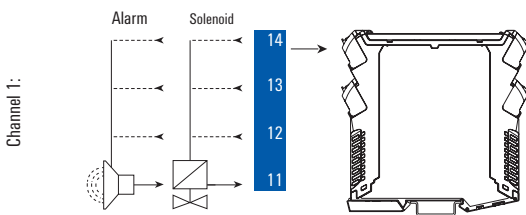

Input Signals

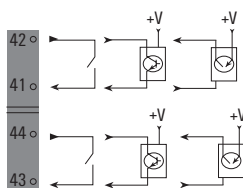

Power supply

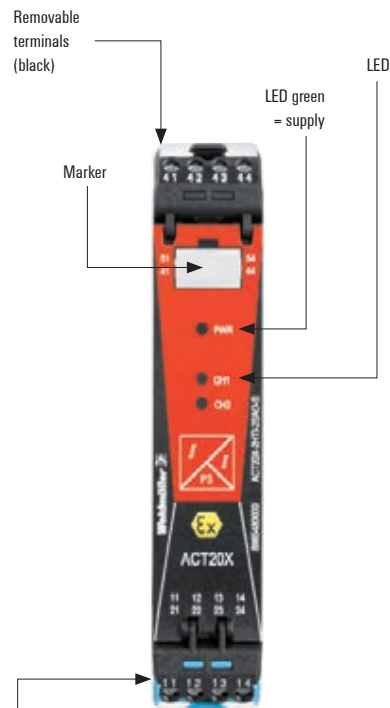
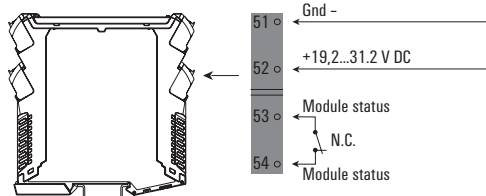

Ex label (excerpt)

ATEX	FM	U_o	28 V
II 3 G Ex nA nC IIC T4	Installation in CL I DIV2 GP A-D T4	I_o	135 mA
II (1) G [Ex ia Ga] IIC/IIB/IIA	KI. III ABT 1/2 GP A-G oder	P_o	0.95 W
II (1) D [Ex iaD]	KI. I Zn2 AEx/Ex nA nC [ia] IIC T4	IIC	$C_o = -$, $L_o = -$
IECEX	Example:	IIB	$C_o = 0.64 \mu F$, $L_o = 7.8 mH$
Ex nA nC IIC T4 Gc	ATEX version,	IIA	$C_o = 2.1 \mu F$, $L_o = 15.1 mH$
[Ex ia Ga] IIC/IIB/IIA	Ex Output Terminal (11-14)		
[Ex ia Da] IIIC	(More details in ATEX certificate)		



Application: Inflow control in Ex zone with gas group IIB

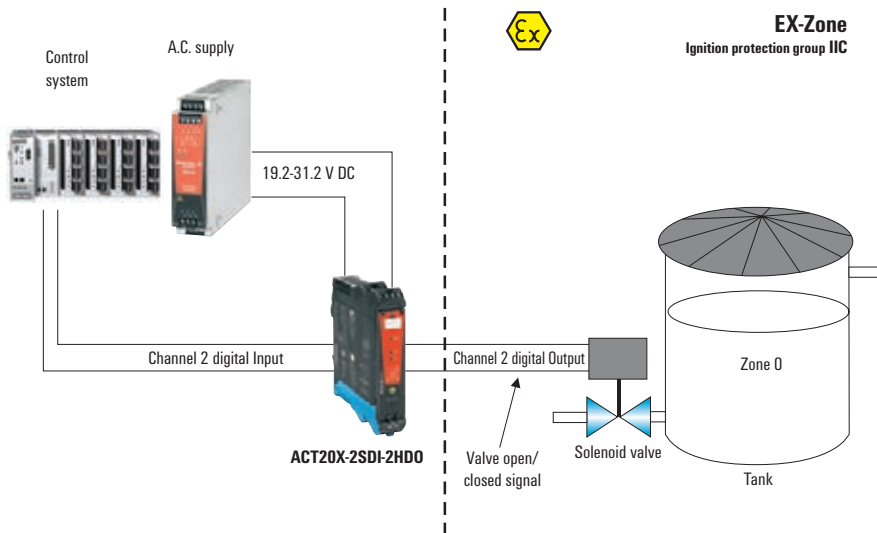

Output data For gas group IIB (≤ 60 mA)

Connection terminal	Channel 1	U without load	U with load	I max
11-12		Min. 24 V	Min. 9 V	60 mA
			Min. 11.5 V	50 mA
11-13		Min. 24 V	Min. 12.5 V	60 mA
			Min. 10 V	50 mA
11-14		Min. 24 V	Min. 11 V	60 mA
			Min. 13 V	50 mA

Note

Valve control module

- Valve control component for control of intrinsically safe valves, LEDs, acoustic alarms, etc.
- PC configuration with FDT/DTM software, download at www.weidmuller.com
- Output current is limited to 35 mA for ignition group IIC
- 1 or 2 channels in one module
- Relay output for error alarm

ACT20X-SDI-HD0-H-S

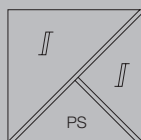

Technical data

Input	
Type	NPN, PNP switching signal
Input voltage	≤ 28 V DC
Input resistance, voltage	3.5 kΩ
Trigger level low	≤ 2.0 V DC (NPN), ≤ 8.0 V DC (PNP)
Trigger level high	≥ 4.0 V DC (NPN), ≥ 10V DC (PNP)
Alarm output	
Type	Relay, 1 NC (voltage-free)
Nominal switching voltage	≤ 125 V AC / 110 V DC (safe area) ≤ 32 V AC / 32 V DC (Zone 2)
Continuous current	≤ 0.5 A AC / 0.3 A DC (safe zone), ≤ 0.5 A AC / 1 A DC (Zone 2)
Power rating	≤ 62.5 VA / 32 W (safe area) ≤ 16 VA / 32 W (Zone 2)
General data	
Supply voltage	19.2 - 31.2 V DC
Power consumption	< 2 W
Tightening torque, min. / Tightening torque, max.	0.4 Nm / 0.6 Nm
Ambient temperature / Storage temperature	-20 °C...+60 °C / -20 °C...+85 °C
Approvals	
Approvals	cULus; DETNORVER; FMEX; GOSTEX; GOSTME25; IECEXKEM; KEMAATEX
Insulation coordination	
Insulation voltage	2.6 kV (input / output)
Rated voltage	300 V
EMC standards	DIN EN 61326

Dimensions	
Clamping range (nominal / min. / max.)	mm ²
Length x width x height	mm
Note	

Screw connection	
	2.5 / 0.5 / 2.5
	119.2 / 22.5 /

Ordering data

Type	Qty.	Order No.
1-channel version		
ACT20X-SDI-HD0-H-S	1 ST	8965410000

CBX200 USB configuration adapter - 8978580000

Signal converters in 6 mm width

Signal converters in 6 mm width	Universal signal converter in 6 mm width - Overview	C.2
	ACT20M - Overview	C.4
	CH20M rail bus	C.26
	MCZ-SERIES - Overview	C.30
	MCZ SERIES - DC/DC passive isolator	C.32
	MCZ-SERIES - PT100 /RTD signal converter	C.33
	MCZ-SERIES - Frequency signal converter	C.34
	MCZ-SERIES - Threshold monitoring	C.35

Analogue signal converter in 6 mm width

The thinnest signal converter for isolating, converting and monitoring analogue signals

The signal converters and the signal separators in the product family ACT20M, MICROSERIES and the MCZ enables the user to integrate many signal channels within a compact space. In addition to galvanic separation, these products offer the conversion and conditioning of DC and

temperature signals (TC and RTD) to standard norm signals (e.g. 4...20 mA, 0...10 V). The pluggable cross-connections option for MAS/MAZ and MCZ ranges, or the Weidmüller rail bus option for the ACT20M ensure a quick installation.

C

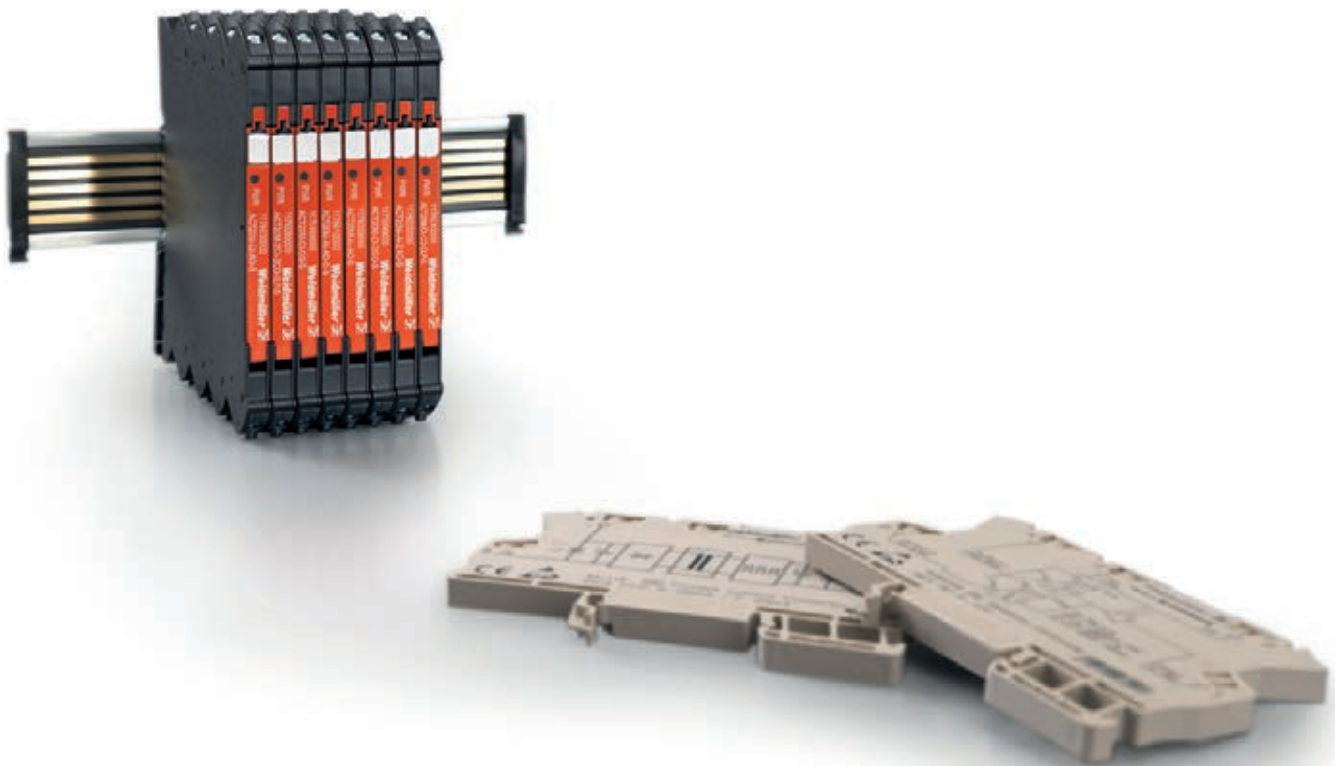

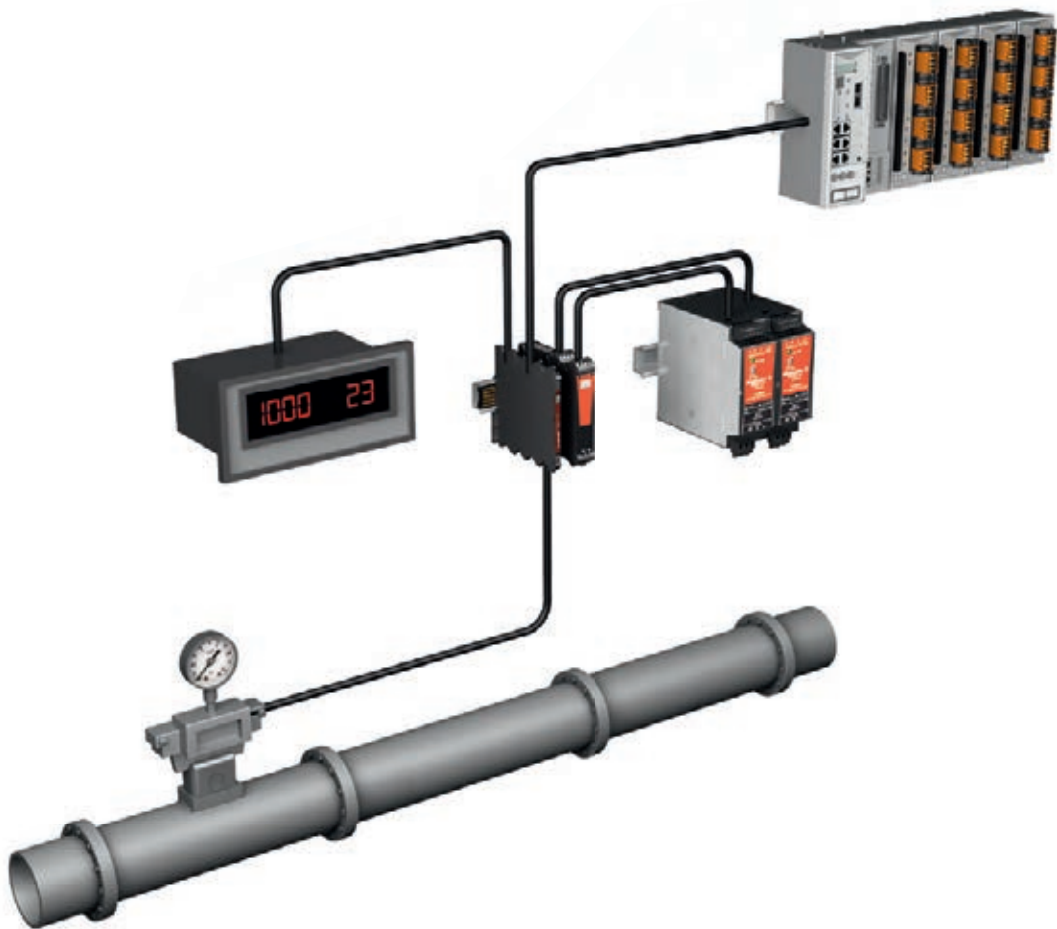

ACT20M



MCZ-SERIES

ACT20M – a narrow 6 mm signal converter

The new dimension for converting and isolating – housed in a 6 mm width

The new ACT20M range combines innovative technologies with the highest levels of functionality in an electronics housing measuring just 6 mm in width. Up to two channels per module result in space savings in the electrical cabinet. The high electrical isolation of 2.5 kV and an accuracy of up to 0.05 % both help to ensure a high degree of process reliability.

The product line consists of Input Loop Powered, Output Loop Powered and Auxiliary Powered analog isolators and converters, including a universal input converter.

The eight-connection housing allows additional functionality such as 2 channel ILP, 2 channel OLP isolation and signal splitting with input powering option. The configuration is carried out via DIP switches or the FDT/ DTM software. The ACT20M modules are supplied via direct wiring or a rail bus.





The DIP switch can be configured simply on the module

In the “ACT20M Tool” software, simply select the type of input and output, and set the DIP switch configuration as displayed.



Easy configuration

DIP switches on the side are used to configure the input and output parameters, as well as the response time.

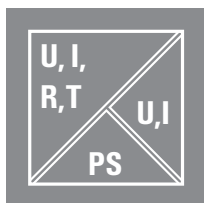

High level of galvanic isolation

2.5 kV of electrical isolation (300 V rated voltage) ensures excellent process reliability.



Installation is simple and quick

The power supply is simply snapped onto the rail bus for fast and easy installation. The supply can be through any ACT20M module or a separate power-feed unit.



Signal splitter



Signal converter



Universal measurement and signal converter



Passive isolator



Temperature transducer



CH20M rail bus



Power-feed modules

ACT20M – Selection table

C

		Power supply	Function	Current				
				0 ... 20 mA 1-channel	4 ... 20 mA 1-channel	2 x 0 ... 20 mA 2-channel / splitter	2 x 4 ... 20 mA 2-channel / splitter	
Input	Current	0 ... 20 mA	24 V DC and rail bus	universal	ACT20M-UI-A0-S	ACT20M-UI-A0-S		
			U/I				ACT20M-AI-2A0-S	ACT20M-AI-2A0-S
			Current				ACT20M-CI-2CO-S	ACT20M-CI-2CO-S
			U/I	ACT20M-AI-A0-E-S	ACT20M-AI-A0-E-S			
			U/I	ACT20M-AI-A0-S	ACT20M-AI-A0-S			
			Current	ACT20M-CI-C0-S	ACT20M-CI-C0-S			
			U/I					
		Input Loop Powered	Current					
		Output Loop Powered	Current		ACT20M-CI-C0-OLP-S			
		Current						
		Output Loop Powered	Current				ACT20M-2CI-2CO-OLP-S	
		Input Loop Powered	Current					
		24 V DC	Current					
		4 ... 20 mA	24 V DC and rail bus	universal	ACT20M-UI-A0-S	ACT20M-UI-A0-S		
	U/I					ACT20M-AI-2A0-S	ACT20M-AI-2A0-S	
	Current					ACT20M-CI-2CO-S	ACT20M-CI-2CO-S	
	U/I		ACT20M-AI-A0-E-S	ACT20M-AI-A0-E-S				
	U/I		ACT20M-AI-A0-S	ACT20M-AI-A0-S				
	Current		ACT20M-CI-C0-S	ACT20M-CI-C0-S				
	U/I							
Output Loop Powered	Current		ACT20M-CI-C0-OLP-S					
Current								
2 x 4 ... 20 mA	Output Loop Powered	Current				ACT20M-2CI-2CO-OLP-S		
	24 V DC	Current						
	Input Loop Powered	Current						
1 x 4 ... 20 mA	Output Loop Powered	Current			ACT20M-2CI-2CO-IHP-S	ACT20M-2CI-2CO-IHP-S		
	Current							
	Current							
-10 mA...0...10 mA	24 V DC and rail bus	bipolar	ACT20M-BAI-A0-S	ACT20M-BAI-A0-S	ACT20M-BAI-2A0-S	ACT20M-BAI-2A0-S		
	24 V DC and rail bus	bipolar	ACT20M-BAI-A0-S	ACT20M-BAI-A0-S	ACT20M-BAI-2A0-S	ACT20M-BAI-2A0-S		
-20 mA...0...20 mA	24 V DC and rail bus	universal	ACT20M-UI-A0-S	ACT20M-UI-A0-S				
		U/I	ACT20M-AI-A0-S	ACT20M-AI-A0-S				
with sensor power supply	24 V DC and rail bus	universal	ACT20M-UI-A0-S	ACT20M-UI-A0-S				
		U/I	ACT20M-AI-A0-S	ACT20M-AI-A0-S				
Voltage	0 ... 5 V 1 ... 5 V	24 V DC and rail bus	universal	ACT20M-UI-A0-S	ACT20M-UI-A0-S			
		U/I	ACT20M-AI-A0-E-S	ACT20M-AI-A0-E-S				
		U/I	ACT20M-AI-A0-S	ACT20M-AI-A0-S				
		U/I						
		Output Loop Powered	U/I					
	0 ... 10 V 2 ... 10 V	24 V DC and rail bus	universal	ACT20M-UI-A0-S	ACT20M-UI-A0-S			
		U/I	ACT20M-AI-A0-E-S	ACT20M-AI-A0-E-S				
		U/I	ACT20M-AI-A0-S	ACT20M-AI-A0-S				
		U/I						
		Output Loop Powered	U/I					
-5 V ... 0 ... 5 V	24 V DC and rail bus	bipolar	ACT20M-BAI-A0-S	ACT20M-BAI-A0-S	ACT20M-BAI-2A0-S	ACT20M-BAI-2A0-S		
	24 V DC and rail bus	bipolar	ACT20M-BAI-A0-S	ACT20M-BAI-A0-S	ACT20M-BAI-2A0-S	ACT20M-BAI-2A0-S		
-10 V... 0 ... 10 V	24 V DC and rail bus	bipolar	ACT20M-BAI-A0-S	ACT20M-BAI-A0-S	ACT20M-BAI-2A0-S	ACT20M-BAI-2A0-S		
		bipolar	ACT20M-BAI-A0-S	ACT20M-BAI-A0-S	ACT20M-BAI-2A0-S	ACT20M-BAI-2A0-S		

Note: *) available from July 2013

ACT20M – Selection table

C

		Power supply	Function	Current				
				0 ... 20 mA 1-channel	4 ... 20 mA 1-channel	2 x 0 ... 20 mA 2-channel / splitter	2 x 4 ... 20 mA 2-channel / splitter	
Input	2-, 3-, 4-conductor	PT100	Output Loop Powered	Temp.		ACT20M-RTCI-CO-DLP-S		
				Temp.		ACT20M-RTI-CO-EOLP-S		
			24 V DC	Temp.	ACT20M-RTI-AO-E-S	ACT20M-RTI-AO-E-S		
				Temp.				
			24 V DC and rail bus	universal	ACT20M-UI-AO-S	ACT20M-UI-AO-S		
		Temp.	ACT20M-RTI-AO-S	ACT20M-RTI-AO-S				
		Temp.	ACT20M-RTCI-AO-S	ACT20M-RTCI-AO-S				
		PT1000	24 V DC and rail bus	universal	ACT20M-UI-AO-S	ACT20M-UI-AO-S		
		Ni100	24 V DC and rail bus	universal	ACT20M-UI-AO-S	ACT20M-UI-AO-S		
		NI1000	24 V DC and rail bus	universal	ACT20M-UI-AO-S	ACT20M-UI-AO-S		
	TC	B	24 V DC and rail bus	universal	ACT20M-UI-AO-S	ACT20M-UI-AO-S		
		E	24 V DC and rail bus	universal	ACT20M-UI-AO-S	ACT20M-UI-AO-S		
		J	Output Loop Powered	Temp.			ACT20M-RTCI-CO-DLP-S	
			24 V DC	Temp.	ACT20M-TCI-AO-E-S	ACT20M-TCI-AO-E-S		
			24 V DC and rail bus	universal	ACT20M-UI-AO-S	ACT20M-UI-AO-S		
				Temp.	ACT20M-TCI-AO-S	ACT20M-TCI-AO-S		
			24 V DC	Temp.				
			Temp.	ACT20M-RTI-AO-S	ACT20M-RTI-AO-S			
		K	Output Loop Powered	Temp.			ACT20M-RTCI-CO-DLP-S	
			24 V DC and rail bus	Temp.	ACT20M-TCI-AO-E-S	ACT20M-TCI-AO-E-S		
			universal	ACT20M-UI-AO-S	ACT20M-UI-AO-S			
			Temp.					
			Temp.	ACT20M-TCI-AO-S	ACT20M-TCI-AO-S			
		Temp.	ACT20M-RTI-AO-S	ACT20M-RTI-AO-S				
L		24 V DC and rail bus	universal	ACT20M-UI-AO-S	ACT20M-UI-AO-S			
LR	24 V DC and rail bus	universal	ACT20M-UI-AO-S	ACT20M-UI-AO-S				
N	24 V DC and rail bus	universal	ACT20M-UI-AO-S	ACT20M-UI-AO-S				
R	24 V DC and rail bus	universal	ACT20M-UI-AO-S	ACT20M-UI-AO-S				
S	24 V DC and rail bus	universal	ACT20M-UI-AO-S	ACT20M-UI-AO-S				
T	24 V DC and rail bus	universal	ACT20M-UI-AO-S	ACT20M-UI-AO-S				
U	24 V DC and rail bus	universal	ACT20M-UI-AO-S	ACT20M-UI-AO-S				
W3	24 V DC and rail bus	universal	ACT20M-UI-AO-S	ACT20M-UI-AO-S				
W5	24 V DC and rail bus	universal	ACT20M-UI-AO-S	ACT20M-UI-AO-S				
Poti	10R ...100k	24 V DC and rail bus	universal	ACT20M-UI-AO-S	ACT20M-UI-AO-S			
R	10R ...100k	24 V DC and rail bus	universal	ACT20M-UI-AO-S	ACT20M-UI-AO-S			

Note: *) available from July 2013

ACT20M

Signal splitter

- Isolation and doubling of DC signals
- Power supply via the mounting rail bus
- 4-way isolation

ACT20M-CI-2CO-S

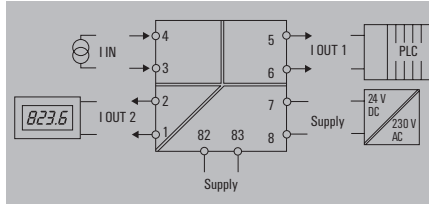

Technical data

Input

Input current
Voltage drop, current input

Output

Output current
Load impedance current

General data

Configuration
Supply voltage
Ambient temperature
Accuracy
Temperature coefficient
Cut-off frequency (-3 dB)
Power consumption, typ.
Power consumption, max.
Step response time

Insulation coordination

Insulation voltage
Rated voltage
Pollution degree
Overvoltage category
Approvals

0...20 mA, 4...20 mA
< 1.5 V
0...20 mA, 4...20 mA
< 300 Ω, per channel, @ max 23mA

none
24 V DC ± 30 %
-25 °C...+70 °C
< 0.05 % of measuring range
≤ 0.01 % / °C
100 Hz
400 mW
0.8 W
≤ 7 ms

2.5 kV_{eff}
300 V_{eff}
2
II
CE; cULus; DETNORVER; FMEX; GL; GOSTME25; IECEXKEM;
KEMAATEX

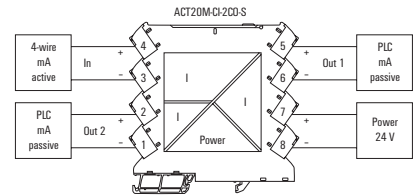

Dimensions

Clamping range (nominal / min. / max.) mm²
Depth x width x height mm

Note

Screw connection

2.5 / 0.5 / 2.5
114.3 / 6.1 / 112.5
Power supply optionally over the DIN mounting rail CH20M

Ordering data

Screw connection

Type	Qty.	Order No.
ACT20M-CI-2CO-S	1	1175990000

Note

Accessories

Note
DIN mounting rail, see Accessories

Signal splitter

- Isolation, conversion and doubling of DC signals
- Configuration via DIP switches
- Power supply via the mounting rail bus
- 4-way isolation
- Support for adjustment by ACT20M Tool software, download link at www.weidmueller.com

ACT20M-AI-2AO-S

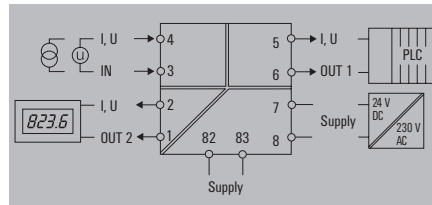

Technical data

Input	
Input current	0...20 mA, 4...20mA
Input voltage	0(2)...10 V, 0(1)...5 V
Sensor supply	> 17 V DC at 20 mA
Input resistance, voltage	500 kΩ
Voltage drop, current input	< 1.5 V

Output	
Output current	0...20 mA
Output voltage	adjustable, 0(2)...10 V, 0(1)...5 V
Load impedance current	< 300 Ω, per channel, @ max 23mA
Load impedance voltage	≥ 10 kΩ

General data	
Configuration	DIP switch
Supply voltage	24 V DC ± 30 %
Ambient temperature	-25 °C...+70 °C
Accuracy	< 0.05 % of measuring range
Temperature coefficient	≤ 0.01 % / °C
Cut-off frequency (-3 dB)	100 Hz
Power consumption, typ.	400 mW
Power consumption, max.	1.2 W
Step response time	≤ 7 ms

Insulation coordination	
Insulation voltage	2.5 kV _{eff}
Rated voltage	300 V _{eff}
Pollution degree	2
Overvoltage category	II
Approvals	CE; cULus; DETNORVER; FMEx; GL; GOSTME25; IECExKEM; KEMAATEX

Dimensions	
Clamping range (nominal / min. / max.)	mm ²
Depth x width x height	mm

Note

Screw connection	
Clamping range (nominal / min. / max.)	mm ²
Depth x width x height	mm

General data	
Configuration	DIP switch
Supply voltage	24 V DC ± 30 %
Ambient temperature	-25 °C...+70 °C
Accuracy	< 0.05 % of measuring range
Temperature coefficient	≤ 0.01 % / °C
Cut-off frequency (-3 dB)	100 Hz
Power consumption, typ.	400 mW
Power consumption, max.	1.2 W
Step response time	≤ 7 ms

Insulation coordination	
Insulation voltage	2.5 kV _{eff}
Rated voltage	300 V _{eff}
Pollution degree	2
Overvoltage category	II
Approvals	CE; cULus; DETNORVER; FMEx; GL; GOSTME25; IECExKEM; KEMAATEX

Dimensions	
Clamping range (nominal / min. / max.)	mm ²
Depth x width x height	mm

Note

Ordering data

Type	Qty.	Order No.
ACT20M-AI-2AO-S	1	1176020000

Note

Accessories

Note

Power supply optionally over the DIN mounting rail CH20M

Type	Qty.	Order No.
ACT20M-AI-2AO-S	1	1176020000

DIN mounting rail, see Accessories

Input	Switch			
	1	2	3	4
0 ... 20 mA	<input type="checkbox"/>	<input type="checkbox"/>	<input type="checkbox"/>	<input type="checkbox"/>
4 ... 20 m	<input type="checkbox"/>	<input type="checkbox"/>	<input checked="" type="checkbox"/>	<input type="checkbox"/>
0 ... 10 V	<input type="checkbox"/>	<input checked="" type="checkbox"/>	<input type="checkbox"/>	<input type="checkbox"/>
2 ... 10 V	<input type="checkbox"/>	<input checked="" type="checkbox"/>	<input checked="" type="checkbox"/>	<input type="checkbox"/>
0 ... 5 V	<input type="checkbox"/>	<input checked="" type="checkbox"/>	<input type="checkbox"/>	<input checked="" type="checkbox"/>
1 ... 5 V	<input type="checkbox"/>	<input checked="" type="checkbox"/>	<input checked="" type="checkbox"/>	<input checked="" type="checkbox"/>
0 ... 20 mA loop	<input checked="" type="checkbox"/>	<input type="checkbox"/>	<input type="checkbox"/>	<input type="checkbox"/>
4 ... 20 mA loop	<input checked="" type="checkbox"/>	<input type="checkbox"/>	<input checked="" type="checkbox"/>	<input type="checkbox"/>

Output 1	Switch		
	5	6	7
0 ... 20 mA	<input type="checkbox"/>	<input type="checkbox"/>	<input type="checkbox"/>
4 ... 20 m	<input type="checkbox"/>	<input checked="" type="checkbox"/>	<input type="checkbox"/>
0 ... 10 V	<input checked="" type="checkbox"/>	<input type="checkbox"/>	<input type="checkbox"/>
2 ... 10 V	<input checked="" type="checkbox"/>	<input checked="" type="checkbox"/>	<input type="checkbox"/>
0 ... 5 V	<input checked="" type="checkbox"/>	<input type="checkbox"/>	<input checked="" type="checkbox"/>
1 ... 5 V	<input checked="" type="checkbox"/>	<input checked="" type="checkbox"/>	<input checked="" type="checkbox"/>

Output 2	Switch		
	8	9	10
0 ... 20 mA	<input type="checkbox"/>	<input type="checkbox"/>	<input type="checkbox"/>
4 ... 20 m	<input type="checkbox"/>	<input checked="" type="checkbox"/>	<input type="checkbox"/>
0 ... 10 V	<input checked="" type="checkbox"/>	<input type="checkbox"/>	<input type="checkbox"/>
2 ... 10 V	<input checked="" type="checkbox"/>	<input checked="" type="checkbox"/>	<input type="checkbox"/>
0 ... 5 V	<input checked="" type="checkbox"/>	<input type="checkbox"/>	<input checked="" type="checkbox"/>
1 ... 5 V	<input checked="" type="checkbox"/>	<input checked="" type="checkbox"/>	<input checked="" type="checkbox"/>

■ = on
□ = off

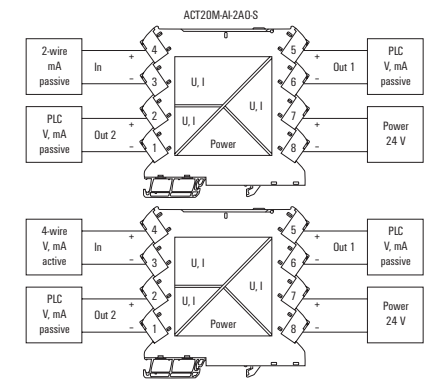

ACT20M

Signal splitter

- Isolation and conversion of bipolar DC signals
- Splitting into standard signal or bipolar output
- Configuration via DIP switches
- Power supply via the mounting rail bus
- 4-way isolation
- Support for adjustment by ACT20M Tool software, download link at www.weidmueller.com

ACT20M-BAI-2A0-S

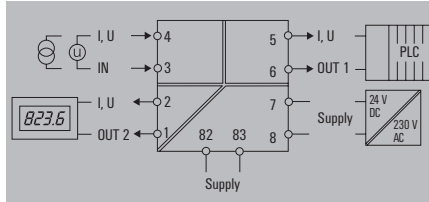

Technical data

Input

Input current
Input voltage

Output

Output current
Output voltage
Load impedance current
Load impedance voltage

General data

Supply voltage
Ambient temperature
Storage temperature
Accuracy
Temperature coefficient
Cut-off frequency (-3 dB)

Insulation coordination

Insulation voltage
Rated voltage
Pollution degree
Overvoltage category

Approvals

Approvals

-10 mA...0...+10 mA, -20 mA...0...+20 mA
-5 V...0...+5 V, -10 V...0...+10 V

adjustable, 0...20 mA, 4...20 mA, ± 10 mA, ± 20 mA

adjustable, 0(2)...10 V, 0(1)...5 V

< 300 Ω , per channel

≥ 10 k Ω

24 V DC ± 30 %

-25 °C...+70 °C

-40 °C...+85 °C

< 0.05 % of measuring range

< 0.01% of span/°C (TU)

≥ 100 Hz, 10 Hz

2.5 kV_{eff}

300 V_{eff}

2

II

cULus; DETNORVER; FMEX; GL; IECEXKEM; KEMAATEX

Dimensions

Clamping range (nominal / min. / max.) mm²
Depth x width x height mm

Note

2.5 / 0.5 / 2.5

114.3 / 6.1 / 112.5

Ordering data

Type	Qty.	Order No.
ACT20M-BAI-2A0-S	1	1375470000

Note

Accessories

Note
DIN mounting rail, see Accessories

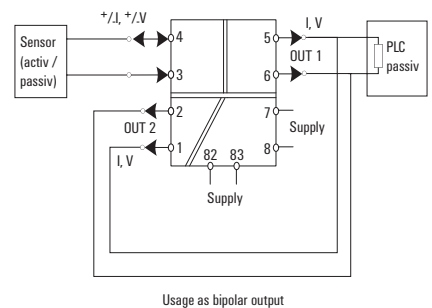

Signal isolator

- Isolation of DC signals
- Power supply via the mounting rail bus
- 3-way isolation

ACT20M-CI-CO-S

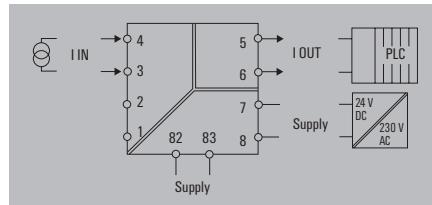

Technical data

Input

Input current
Voltage drop, current input

Output

Output current
Load impedance current

General data

Configuration
Supply voltage
Ambient temperature
Accuracy
Temperature coefficient
Cut-off frequency (-3 dB)
Power consumption, typ.
Power consumption, max.
Step response time

Insulation coordination

Insulation voltage
Rated voltage
Pollution degree
Overvoltage category
Approvals

0...20 mA, 4...20mA
< 1.5 V

0...20 mA, 4...20 mA
≤ 600 Ω, @ max 23mA

none
24 V DC ± 30 %
-25 °C...+70 °C

< 0.05 % of measuring range
≤ 0.01 % / °C
100 Hz
400 mW

0.8
≤ 7 ms

2.5 kV_{eff}
300 V_{eff}
2

II
CE; cULus; DETNORVER; FMEX; GL; GOSTME25; IECEXKEM;
KEMAATEX

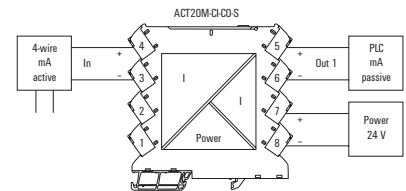

Dimensions

Clamping range (nominal / min. / max.) mm²
Depth x width x height mm

Note

Screw connection

2.5 / 0.5 / 2.5
114.3 / 6.1 / 112.5

Power supply optionally over the DIN mounting rail CH20M

Ordering data

Screw connection

Type	Qty.	Order No.
ACT20M-CI-CO-S	1	1175980000

Note

Accessories

Note

DIN mounting rail, see Accessories

ACT20M

Signal converter

- Isolation and conversion of DC signals
- Configuration via DIP switches
- Power supply via the mounting rail bus
- 3-way isolation
- Support for adjustment by ACT20M Tool software, download link at www.weidmueller.com

ACT20M-AI-AO-S

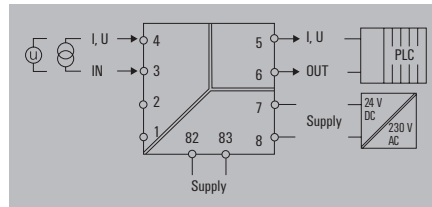

Technical data

Input	
Input current	0...20 mA, 4...20mA
Input voltage	0(2)...10 V, 0(1)...5 V
Sensor supply	> 17 V DC at 20 mA
Input resistance, voltage	>500 kΩ
Voltage drop, current input	<1,5 V

Output	
Output current	adjustable, 0...20 mA, 4...20 mA
Output voltage	adjustable, 0(2)...10 V, 0(1)...5 V
Load impedance current	≤ 600 Ω, @ max 23mA
Load impedance voltage	≥ 10 kΩ

General data	
Configuration	DIP switch
Supply voltage	24 V DC ± 30 %
Ambient temperature	-25 °C...+70 °C
Accuracy	< 0.05 % of measuring range
Temperature coefficient	≤ 0.01 % / °C
Cut-off frequency (-3 dB)	100 Hz
Power consumption, typ.	400 mW
Power consumption, max.	1.2 W
Step response time	≤ 7 ms

Insulation coordination	
Insulation voltage	2.5 kV _{eff}
Rated voltage	300 V _{eff}
Pollution degree	2
Overvoltage category	II
Approvals	CE; cULus; DETNORVER; FMEX; GL; GOSTME25; IECExKEM; KEMAATEX

Dimensions	
Clamping range (nominal / min. / max.)	mm ²
Depth x width x height	mm

Note

Switch	
Input	Switch
	1 2 3 4
0 ... 20 mA	<input type="checkbox"/> <input type="checkbox"/> <input type="checkbox"/> <input type="checkbox"/>
4 ... 20 m	<input type="checkbox"/> <input type="checkbox"/> <input checked="" type="checkbox"/> <input type="checkbox"/>
0 ... 10 V	<input type="checkbox"/> <input checked="" type="checkbox"/> <input type="checkbox"/> <input type="checkbox"/>
2 ... 10 V	<input type="checkbox"/> <input checked="" type="checkbox"/> <input checked="" type="checkbox"/> <input type="checkbox"/>
0 ... 5 V	<input type="checkbox"/> <input checked="" type="checkbox"/> <input type="checkbox"/> <input checked="" type="checkbox"/>
1 ... 5 V	<input type="checkbox"/> <input checked="" type="checkbox"/> <input checked="" type="checkbox"/> <input checked="" type="checkbox"/>
0 ... 20 mA loop	<input checked="" type="checkbox"/> <input type="checkbox"/> <input type="checkbox"/> <input type="checkbox"/>
4 ... 20 mA loop	<input checked="" type="checkbox"/> <input type="checkbox"/> <input checked="" type="checkbox"/> <input type="checkbox"/>

Switch	
Output 1	Switch
	5 6 7
0 ... 20 mA	<input type="checkbox"/> <input type="checkbox"/> <input type="checkbox"/>
4 ... 20 m	<input type="checkbox"/> <input checked="" type="checkbox"/> <input type="checkbox"/>
0 ... 10 V	<input checked="" type="checkbox"/> <input type="checkbox"/> <input type="checkbox"/>
2 ... 10 V	<input checked="" type="checkbox"/> <input checked="" type="checkbox"/> <input type="checkbox"/>
0 ... 5 V	<input checked="" type="checkbox"/> <input type="checkbox"/> <input checked="" type="checkbox"/>
1 ... 5 V	<input checked="" type="checkbox"/> <input checked="" type="checkbox"/> <input checked="" type="checkbox"/>

■ = on
□ = off

Switch	
Output 1	Switch
	5 6 7
0 ... 20 mA	<input type="checkbox"/> <input type="checkbox"/> <input type="checkbox"/>
4 ... 20 m	<input type="checkbox"/> <input checked="" type="checkbox"/> <input type="checkbox"/>
0 ... 10 V	<input checked="" type="checkbox"/> <input type="checkbox"/> <input type="checkbox"/>
2 ... 10 V	<input checked="" type="checkbox"/> <input checked="" type="checkbox"/> <input type="checkbox"/>
0 ... 5 V	<input checked="" type="checkbox"/> <input type="checkbox"/> <input checked="" type="checkbox"/>
1 ... 5 V	<input checked="" type="checkbox"/> <input checked="" type="checkbox"/> <input checked="" type="checkbox"/>

Switch	
Output 1	Switch
	5 6 7
0 ... 20 mA	<input type="checkbox"/> <input type="checkbox"/> <input type="checkbox"/>
4 ... 20 m	<input type="checkbox"/> <input checked="" type="checkbox"/> <input type="checkbox"/>
0 ... 10 V	<input checked="" type="checkbox"/> <input type="checkbox"/> <input type="checkbox"/>
2 ... 10 V	<input checked="" type="checkbox"/> <input checked="" type="checkbox"/> <input type="checkbox"/>
0 ... 5 V	<input checked="" type="checkbox"/> <input type="checkbox"/> <input checked="" type="checkbox"/>
1 ... 5 V	<input checked="" type="checkbox"/> <input checked="" type="checkbox"/> <input checked="" type="checkbox"/>

■ = on
□ = off

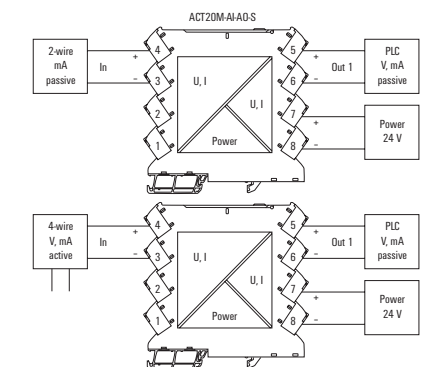

Ordering data

Screw connection

Type	Qty.	Order No.
ACT20M-AI-AO-S	1	117600000

Note

Accessories

Note

DIN mounting rail, see Accessories

Signal converter

- Isolation and conversion of DC signals
- Configuration via DIP switches
- Power supply via the mounting rail bus
- 3-way isolation
- Support for adjustment by ACT20M Tool software, download link at www.weidmueller.com

ACT20M-AI-AO-E-S

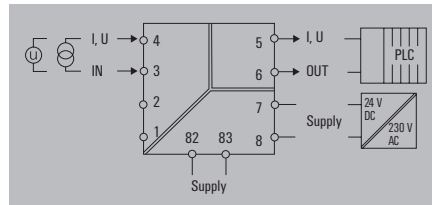

Technical data

Input	
Input current	0...20 mA, 4...20mA
Input voltage	0(2)...10 V, 0(1)...5 V
Input resistance, voltage	>500 kΩ
Voltage drop, current input	<1,5 V
Output	
Output current	adjustable, 0...20 mA, 4...20 mA
Output voltage	adjustable, 0(2)...10 V, 0(1)...5 V
Load impedance current	≤ 600 Ω, @ max 23mA
Load impedance voltage	≥ 10 kΩ
General data	
Configuration	DIP switch
Supply voltage	24 V DC ± 30 %
Ambient temperature	0 °C...+70 °C
Accuracy	< 0.2 % of measuring range
Temperature coefficient	≤ 0.015 % / °C
Cut-off frequency (-3 dB)	100 Hz
Power consumption, typ.	400 mW
Power consumption, max.	1.2 W
Step response time	≤ 7 ms
Insulation coordination	
Insulation voltage	2.5 kV _{eff}
Rated voltage	300 V _{eff}
Pollution degree	2
Overvoltage category	II
Approvals	CE; cULus; DETNORVER; GL; GOSTME25

Input		Switch			
		1	2	3	4
0 ... 20 mA		<input type="checkbox"/>	<input type="checkbox"/>	<input type="checkbox"/>	<input type="checkbox"/>
4 ... 20 m		<input type="checkbox"/>	<input type="checkbox"/>	<input checked="" type="checkbox"/>	<input type="checkbox"/>
0 ... 10 V		<input type="checkbox"/>	<input checked="" type="checkbox"/>	<input type="checkbox"/>	<input type="checkbox"/>
2 ... 10 V		<input type="checkbox"/>	<input checked="" type="checkbox"/>	<input checked="" type="checkbox"/>	<input type="checkbox"/>
0 ... 5 V		<input type="checkbox"/>	<input checked="" type="checkbox"/>	<input type="checkbox"/>	<input checked="" type="checkbox"/>
1 ... 5 V		<input type="checkbox"/>	<input checked="" type="checkbox"/>	<input checked="" type="checkbox"/>	<input checked="" type="checkbox"/>
■ = on □ = off					
Output 1		Switch			
		5	6	7	
0 ... 20 mA		<input type="checkbox"/>	<input type="checkbox"/>	<input type="checkbox"/>	
4 ... 20 m		<input type="checkbox"/>	<input checked="" type="checkbox"/>	<input type="checkbox"/>	
0 ... 10 V		<input checked="" type="checkbox"/>	<input type="checkbox"/>	<input type="checkbox"/>	
2 ... 10 V		<input checked="" type="checkbox"/>	<input checked="" type="checkbox"/>	<input type="checkbox"/>	
0 ... 5 V		<input checked="" type="checkbox"/>	<input type="checkbox"/>	<input checked="" type="checkbox"/>	
1 ... 5 V		<input checked="" type="checkbox"/>	<input checked="" type="checkbox"/>	<input checked="" type="checkbox"/>	

Input		Switch			
		1	2	3	4
0 ... 20 mA		<input type="checkbox"/>	<input type="checkbox"/>	<input type="checkbox"/>	<input type="checkbox"/>
4 ... 20 m		<input type="checkbox"/>	<input type="checkbox"/>	<input checked="" type="checkbox"/>	<input type="checkbox"/>
0 ... 10 V		<input type="checkbox"/>	<input checked="" type="checkbox"/>	<input type="checkbox"/>	<input type="checkbox"/>
2 ... 10 V		<input type="checkbox"/>	<input checked="" type="checkbox"/>	<input checked="" type="checkbox"/>	<input type="checkbox"/>
0 ... 5 V		<input type="checkbox"/>	<input checked="" type="checkbox"/>	<input type="checkbox"/>	<input checked="" type="checkbox"/>
1 ... 5 V		<input type="checkbox"/>	<input checked="" type="checkbox"/>	<input checked="" type="checkbox"/>	<input checked="" type="checkbox"/>

Output 1		Switch		
		5	6	7
0 ... 20 mA		<input type="checkbox"/>	<input type="checkbox"/>	<input type="checkbox"/>
4 ... 20 m		<input type="checkbox"/>	<input checked="" type="checkbox"/>	<input type="checkbox"/>
0 ... 10 V		<input checked="" type="checkbox"/>	<input type="checkbox"/>	<input type="checkbox"/>
2 ... 10 V		<input checked="" type="checkbox"/>	<input checked="" type="checkbox"/>	<input type="checkbox"/>
0 ... 5 V		<input checked="" type="checkbox"/>	<input type="checkbox"/>	<input checked="" type="checkbox"/>
1 ... 5 V		<input checked="" type="checkbox"/>	<input checked="" type="checkbox"/>	<input checked="" type="checkbox"/>

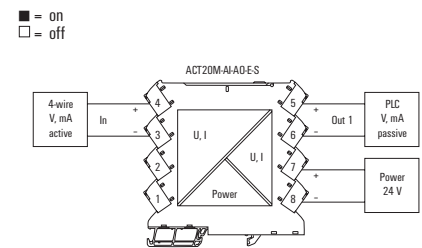

Dimensions	
Clamping range (nominal / min. / max.)	mm ²
Depth x width x height	mm
Note	

Screw connection	
2.5 / 0.5 / 2.5	
114.3 / 6.1 / 112.5	
Note	
Power supply optionally over the DIN mounting rail CH20M	

Ordering data

Screw connection

Type	Qty.	Order No.
ACT20M-AI-AO-E-S	1	1176010000

Note

Accessories

Note

DIN mounting rail, see Accessories

ACT20M

Signal converter

- Isolation and conversion of bipolar DC signals into standard signals
- Configuration via DIP switches
- Power supply via the mounting rail bus
- 3-way isolation
- Support for adjustment by ACT20M Tool software, download link at www.weidmuller.com

ACT20M-BAI-A0-S

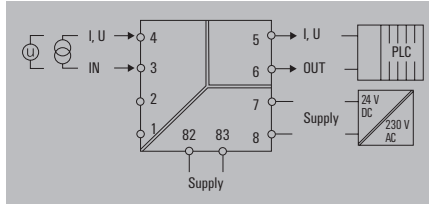

Technical data

Input

Input current
Input voltage

-10 mA...0...+10 mA, -20 mA...0...+20 mA
-5 V...0...+5 V, -10 V...0...+10 V

Output

Output current
Output voltage
Load impedance current
Load impedance voltage

0...20 mA, 4...20 mA
adjustable, 0(2)...10 V, 0(1)...5 V
≤ 600 Ω
≥ 10 kΩ

General data

Configuration
Supply voltage
Ambient temperature
Storage temperature
Accuracy
Temperature coefficient
Cut-off frequency (-3 dB)

DIP switch
24 V DC ± 30 %
-25 °C...+70 °C
-40 °C...+85 °C
< 0.05 % of measuring range
< 0.01 % of span/°C (TU)
≥ 100 Hz, 10 Hz

Insulation coordination

Insulation voltage
Rated voltage
Pollution degree
Overvoltage category

2.5 kV_{eff}
300 V_{eff}
2
II

Approvals

Approvals

cULus; DETNORVER; FMEX; GL; IECEXKEM; KEMAATEX

Dimensions

Clamping range (nominal / min. / max.) mm²
Depth x width x height mm

2.5 / 0.5 / 2.5
114.3 / 6.1 / 112.5

Note

Power supply optionally via mounting rail bus CH20M

Ordering data

Type	Qty.	Order No.
ACT20M-BAI-A0-S	1	1375450000

Note

Accessories

Note

Mounting rail bus, see Accessories

Universal measurement and signal converter

- Isolation and conversion of temperature signals and DC signals
- Configuration using FDT/DTM software
- Power supply via the mounting rail bus
- 3-way isolation

ACT20M-UI-A0-S

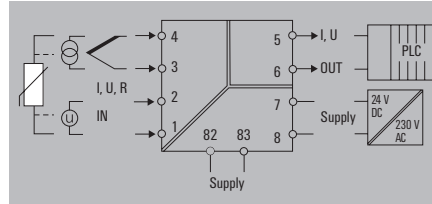

Technical data

Input	
Sensor	
Potentiometer	
Resistance	
Input current	
Input voltage	
Input resistance, voltage	
Voltage drop, current input	
Sensor supply	
Output	
Output current	
Output voltage	
Load impedance current	
Load impedance voltage	
General data	
Configuration	
Supply voltage	
Ambient temperature	
Accuracy	
Temperature coefficient	
Power consumption, typ.	
Power consumption, max.	
Step response time	
Insulation coordination	
Insulation voltage	
Rated voltage	
Pollution degree	
Overvoltage category	
Approvals	
Dimensions	
Clamping range (nominal / min. / max.)	mm ²
Depth x width x height	mm
Note	

Thermocouples: B, E, J, K, L, LR, N, R, N, R, S, T, U, W3, W5, RTD: PT100, PT1000, Ni100, Ni1000, 2-/3-/4-wire	
10 Ω...10 kΩ	
10 Ω...10 kΩ	
0...20 mA, 4...20mA	
0(2)...10 V, 0(1)...5 V	
> 10 MΩ	
< 3 V	
> 15 V DC at 20 mA	
adjustable, 0...20 mA, 4...20 mA	
adjustable, 0(2)...10 V, 0(1)...5 V	
≤ 600 Ω, @ max 28mA	
≥ 10 kΩ	
With FDT/DTM software	
24 V DC ± 30 %	
-25 °C...+70 °C	
< 0.1 % of measuring range	
≤ 0.01 % / °C	
400 mW	
1.2 W	
400 ms (10...90%) @ U/I, 1 s @ temp	
2.5 kV _{eff}	
300 V _{eff}	
2	
II	
cULus; DETNORVER; FMEX; GL; GOSTME25; IECExKEM; KEMAATEX	
Screw connection	
2.5 / 0.5 / 2.5	
114.3 / 6.1 / 112.5	
Power supply optionally over the DIN mounting rail CH20M	

Ordering data

Screw connection

Type	Qty.	Order No.
ACT20M-UI-A0-S	1	1176030000

Note

Accessories

Note	CBX200 USB configuration adapter - 8978580000 DIN mounting rail, see Accessories
-------------	---

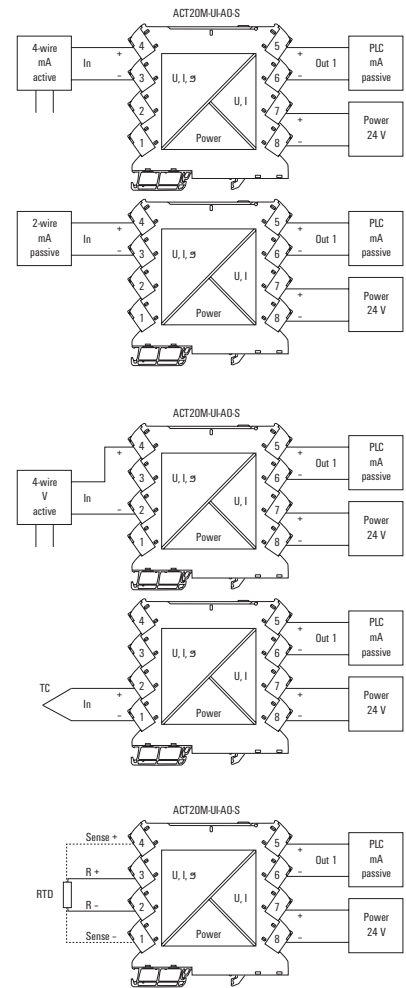

ACT20M

Passive isolator

- Isolation of DC signals without additional voltage supply
- Supply from the input measuring circuit
- Optionally available as a 1-channel / 2-channel version
- 2-way isolation

ACT20M-CI-CO-ILP-S

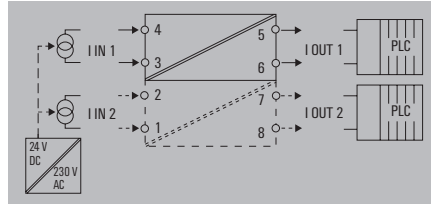

Technical data

Input	
Voltage drop, current input	
Input current	
Output	
Output current	
Load impedance current	
General data	
Configuration	none
Ambient temperature	-25 °C...+70 °C
Accuracy	< 0.1 % of measuring range
Temperature coefficient	≤ 0.01 % / °C
Cut-off frequency (-3 dB)	100 Hz
Power consumption, max.	30 mW per channel
Step response time	≤ 5 ms
Insulation coordination	
Insulation voltage	2.5 kV _{eff}
Rated voltage	300 V _{eff}
Pollution degree	2
Overtoltage category	II
Approvals	cULus; DETNORVER; FMEX; GL; GOSTME25; IECExKEM; KEMAATEX

1.25 V + 0.015 V _{out} @25°C
0...20 mA, 4...20mA
0...20 mA, 4...20 mA
≤ 600 Ω, @ max 23mA
none
-25 °C...+70 °C
< 0.1 % of measuring range
≤ 0.01 % / °C
100 Hz
30 mW per channel
≤ 5 ms
2.5 kV _{eff}
300 V _{eff}
2
II
cULus; DETNORVER; FMEX; GL; GOSTME25; IECExKEM; KEMAATEX

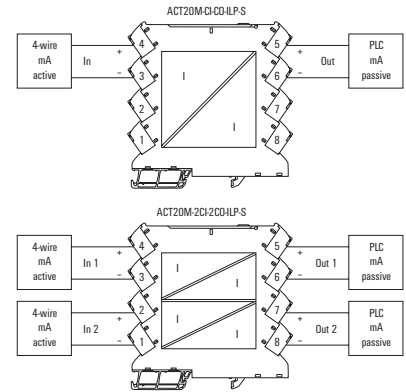

Dimensions	
Clamping range (nominal / min. / max.)	mm ²
Depth x width x height	mm
Note	

1-channel version	
2.5 / 0.5 / 2.5	
114.3 / 6.1 / 112.5	
Power supply optionally over the DIN mounting rail CH20M	

Ordering data

1-channel version
2-channel version

Type	Qty.	Order No.
ACT20M-CI-CO-ILP-S	1	1176070000
ACT20M-2CI-2CO-ILP-S	1	1176080000

Note

Accessories

Note

Note

DIN mounting rail, see Accessories

Passive isolator

- Isolation of DC signals without additional voltage supply
- Supply from the output measurement circuit
- Optionally available as a 1-channel / 2-channel version
- 2-way isolation

ACT20M-CI-CO-OLP-S

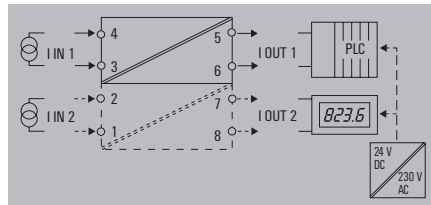

Technical data

Input	
Voltage drop, current input	Typical 2.5 V
Input current	4...20 mA
Output	
Output current	4...20 mA
Supply voltage	6...35 V
General data	
Configuration	none
Ambient temperature	-25 °C...+70 °C
Accuracy	< 0.05 % of measuring range
Temperature coefficient	$\leq \pm 0.07 \mu\text{A} \times (\Delta \text{ }^\circ\text{C} \times \text{V}_{\text{supply}})$ @ Tamb < 25 °C $\leq \pm 0.02 \mu\text{A} \times (\Delta \text{ }^\circ\text{C} \times \text{V}_{\text{supply}})$ @ Tamb > 25 °C
Cut-off frequency (-3 dB)	100 Hz
Power consumption, max.	30 mW per channel
Step response time	$\leq 5 \text{ ms}$
Insulation coordination	
Insulation voltage	2.5 kV _{eff}
Rated voltage	300 V _{eff}
Pollution degree	2
Overvoltage category	II
Approvals	cULus; DETNORVER; FMEX; GL; GOSTME25; IECExKEM; KEMAATEX

1-channel version	
Clamping range (nominal / min. / max.)	2.5 / 0.5 / 2.5
Depth x width x height	114.3 / 6.1 / 112.5
Note	Power supply optionally over the DIN mounting rail CH20M

Dimensions	
Clamping range (nominal / min. / max.)	mm ²
Depth x width x height	mm
Note	

Ordering data

1-channel version	
2-channel version	

Type	Qty.	Order No.
ACT20M-CI-CO-OLP-S	1	1176040000
ACT20M-2CI-2CO-OLP-S	1	1176050000

Note	
-------------	--

Accessories

Note	DIN mounting rail, see Accessories
-------------	------------------------------------

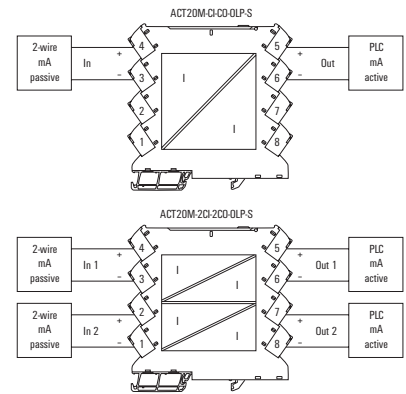

ACT20M

Temperature transducer

- Isolation and conversion of temperature signals, (RTD and thermocouple)
- Configuration via DIP switches
- Power supply via the output circuit
- 2-way isolation

ACT20M-RTCI-CO-OLP-S

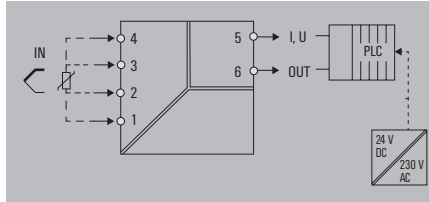

Technical data

Input

Sensor

Input measurement range

Temperature input range

Output

Output current

Sensor error detection

General data

Configuration

Supply voltage

Power consumption

Storage temperature

Accuracy

Galvanic isolation

Step response time

Ambient temperature

Insulation coordination

Insulation voltage

Rated voltage

Pollution degree

Overvoltage category

Approvals

Approvals

PT100 / 2-/3-/4-wire, Thermocouple acc. to IEC 584, type: J, Thermocouple acc. to IEC 584, type: K

PT100 -200...+850 °C, Thermocouple type J -100...+1200°C, Thermocouple type K -200...+1370°C

Configurable

4...20 mA, 20...4 mA

3.5 mA / 23 mA / none

DIP switch

Output loop powered

ca. 1 W

-40 °C...+85 °C

Absolute accuracy: <math>\lt; \pm 0.05\%</math> of the measurement range, RTD (PT100) Basic accuracy: <math>\lt; \pm 0.1\text{ }^\circ\text{C}</math> of the measurement range, TC (J,K) Basic accuracy: <math>\lt; \pm 0.5\text{ }^\circ\text{C}</math> of the measurement range

2-way isolator

<math>\le 30\text{ ms}</math>, <math>\lt; 300\text{ ms}</math>

-25 °C...+70 °C

1.5 kV_{eff}300 V_{eff}

2

II

cULus; DETNORVER; FMEX; GL; IECExKEM; KEMAATEX

Dimensions

Clamping range (nominal / min. / max.)

mm²

Depth x width x height

mm

Note

2.5 / 0.5 / 2.5

114.3 / 6.1 / 112.5

Ordering data

Type	Qty.	Order No.
ACT20M-RTCI-CO-OLP-S	1	1435590000

Note

Accessories

Note

DIN mounting rail, see Accessories

Temperature transducer

- Conversion of temperature signals, RTD
- Configuration via DIP switches
- Power supply via the output circuit

ACT20M-RTI-CO-EOLP-S

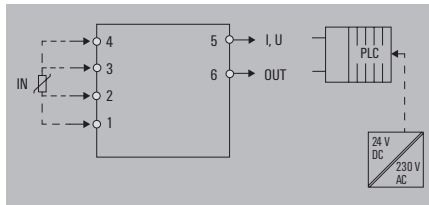

Technical data

Input

Sensor
 Input measurement range
 Temperature input range

Output

Output current
 Sensor error detection

General data

Configuration
 Supply voltage
 Power consumption
 Storage temperature
 Accuracy

Galvanic isolation
 Step response time
 Ambient temperature

Insulation coordination

Insulation voltage
 Rated voltage
 Pollution degree
 Overvoltage category

Approvals

Approvals

PT100 / 2-/3-/4-wire
PT100 -200...+850 °C
Configurable
adjustable, 4...20 mA, 20...4 mA
3.5 mA / 23 mA / none
DIP switch
Output loop powered
ca. 1 W
-40 °C...+85 °C
Absolute accuracy: < ±0.1 % of the measurement range, Basic accuracy: < ±0.2 °C
Without isolation
≤ 30 ms, < 300 ms
-25 °C...+70 °C
1.5 kV _{eff}
300 V _{eff}
2
II
cULus; DETNORVER; FMEX; GL; IECEXKEM; KEMAATEX

Dimensions

Clamping range (nominal / min. / max.) mm²
 Depth x width x height mm

Note

2.5 / 0.5 / 2.5
 114.3 / 6.1 / 112.5

Ordering data

Type	Qty.	Order No.
ACT20M-RTI-CO-EOLP-S	1	1435610000

Note

Accessories

Note

DIN mounting rail, see Accessories

ACT20M

Temperature transducer

- Isolation and conversion of temperature signals, RTD (PT100)
- Configuration via DIP switches
- Power supply via the mounting rail bus
- 3-way isolation

ACT20M-RTI-A0-S

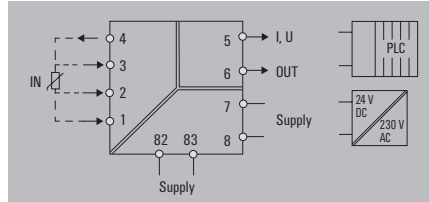

Technical data

Input

Sensor
Input measurement range
Temperature input range

Output

Output current
Output voltage
Load impedance current
Load impedance voltage
Sensor error detection

General data

Configuration
Supply voltage
Power consumption
Accuracy

Galvanic isolation
Temperature coefficient
Step response time
Ambient temperature

Insulation coordination

Insulation voltage
Rated voltage
Pollution degree
Overvoltage category

Approvals

Approvals

PT100 / 2-/3-/4-wire
PT100 -200...+850 °C
Configurable

adjustable, 0...20 mA, 4...20 mA
adjustable, 0(1)...5 V, 0(2)...10 V
≤ 600 Ω
≥ 10 kΩ
3.5 mA / 23 mA / none

DIP switch
24 V DC ± 30 %
ca. 1 W

Absolute accuracy: < ±0.05 % of the measurement range, Basic accuracy: < ±0.1 °C

3-way isolator
≤ 0.01 % of the measurement range/°C or 0.02 °C/°C
≤ 30 ms, < 300 ms
-25 °C +70 °C

2.5 kV_{eff}
300 V_{eff}
2
II

cULus; DETNORVER; FMEX; GL; IECEXKEM; KEMAATEX

Dimensions

Clamping range (nominal / min. / max.) mm²
Depth x width x height mm

Note

2.5 / 0.5 / 2.5
114.3 / 6.1 / 112.5

Ordering data

Type	Qty.	Order No.
ACT20M-RTI-A0-S	1	1375510000

Note

Accessories

Note

DIN mounting rail, see Accessories

Temperature transducer

- Conversion of temperature signals, RTD (PT100)
- Configuration via DIP switches

ACT-20M-RTI-A0-E-S

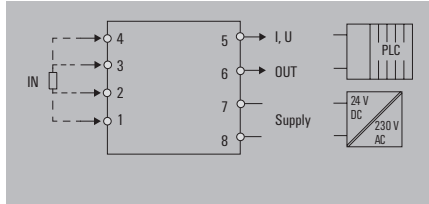

Technical data

Input
Sensor
Input measurement range
Temperature input range
Output
Output current
Output voltage
Load impedance current
Load impedance voltage
Sensor error detection
General data
Configuration
Supply voltage
Power consumption
Accuracy
Galvanic isolation
Temperature coefficient
Step response time
Ambient temperature
Insulation coordination
Insulation voltage
Rated voltage
Pollution degree
Overvoltage category
Approvals
Approvals

PT100 / 2-/3-/4-wire
PT100 -200...+850 °C
Configurable
adjustable, 0...20 mA, 4...20 mA
adjustable, 0(1)...5 V, 0(2)...10 V
≤ 600 Ω
≥ 10 kΩ
3.5 mA / 23 mA / none
DIP switch
24 V DC ± 30 %
ca. 1 W
Absolute accuracy: < ±0.1 % of the measurement range
Without isolation
≤0.01 % of the measurement range/°C or 0.02 °C/°C
≤ 30 ms, < 300 ms
-25 °C +70 °C
2.5 kV _{eff}
300 V _{eff}
2
II
cULus; DETNORVER; FMEX; GL; IECEXKEM; KEMAATEX

Dimensions	
Clamping range (nominal / min. / max.)	mm ²
Depth x width x height	mm
Note	

2.5 / 0.5 / 2.5
114.3 / 6.1 / 112.5

Ordering data

Type	Qty.	Order No.
ACT20M-RTI-A0-E-S	1	1375520000

Note

Accessories

Note

DIN mounting rail, see Accessories

ACT20M

Temperature transducer

- Isolation and conversion of temperature signals, (thermocouple)
- Configuration via DIP switches
- Power supply via the mounting rail bus
- 3-way isolation

ACT20M-TCI-A0-S

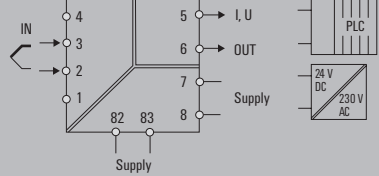

Technical data

Input

Sensor
Input measurement range

Temperature input range

Output

Output current
Output voltage
Load impedance current
Load impedance voltage
Sensor error detection

General data

Configuration
Supply voltage
Power consumption
Accuracy

Galvanic isolation
Temperature coefficient
Step response time
Ambient temperature

Insulation coordination

Insulation voltage
Rated voltage
Pollution degree
Overvoltage category

Approvals

Approvals

Thermocouple (type J, K)

Thermocouple type J -100...+1200°C, Thermocouple type K
-200...+1370°C

Configurable

adjustable, 0...20 mA, 4...20 mA

adjustable, 0(1)...5 V, 0(2)...10 V

≤ 600 Ω

≥ 10 kΩ

3.5 mA / 23 mA / none

DIP switch

24 V DC ± 30 %

ca. 1 W

Absolute accuracy: < ±0.05 % of the measurement range, Basic
accuracy: < ±0.5°

3-way isolator

< 0.1 % / °C

≤ 30 ms, < 300 ms, Configurable

-25 °C...+70°C

2.5 kV_{eff}

300 V_{eff}

2

II

cULus; DETNORVER; FMEX; GL; IECEXKEM; KEMAATEX

Dimensions

Clamping range (nominal / min. / max.) mm²

Depth x width x height mm

Note

2.5 / 0.5 / 2.5

114.3 / 6.1 / 112.5

Ordering data

Type	Qty.	Order No.
ACT20M-TCI-A0-S	1	1375480000

Note

Accessories

Note

DIN mounting rail, see Accessories

Temperature transducer

- Conversion of temperature signals, (thermocouple)
- Configuration via DIP switches

ACT-20M-TCI-A0-E-S

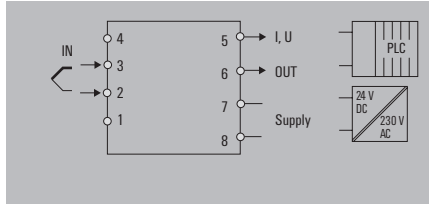

Technical data

Input

Sensor
Input measurement range

Temperature input range

Output

Output current
Output voltage
Load impedance current
Load impedance voltage
Sensor error detection

General data

Configuration
Supply voltage
Power consumption
Accuracy

Galvanic isolation
Temperature coefficient
Step response time
Ambient temperature

Insulation coordination

Insulation voltage
Rated voltage
Pollution degree
Overvoltage category

Approvals

Approvals

Thermocouple (type J, K)

Thermocouple type J -100...+1200°C, Thermocouple type K
-200...+1370°C

Configurable

adjustable, 0...20 mA, 4...20 mA

adjustable, 0(1)...5 V, 0(2)...10 V

≤ 600 Ω

≥ 10 kΩ

3.5 mA / 23 mA / none

DIP switch

24 V DC ± 30 %

ca. 1 W

Absolute accuracy: < ±0.1 % of the measurement range, Basic
accuracy: < ±1 °C

Without isolation

≤ 0.01 % / °C

≤ 30 ms, < 300 ms, Configurable

-25 °C...+70°C

2.5 kV_{eff}

300 V_{eff}

2

II

cULus; DETNORVER; FMEX; GL; IECEXKEM; KEMAATEX

Dimensions

Clamping range (nominal / min. / max.) mm²

Depth x width x height mm

Note

2.5 / 0.5 / 2.5

114.3 / 6.1 / 112.5

Ordering data

Type	Qty.	Order No.
ACT20M-TCI-A0-E-S	1	1375500000

Note

Accessories

Note

DIN mounting rail, see Accessories

CH20M rail bus

Quick and safe power supply through the DIN rail.

This customer-friendly infrastructure solution brings power, signals and data to the rail in a quick and reliable manner. The rail bus can replace the tedious individual wiring process with a flexible and uninterrupted system solution. As a result, the customer saves time and cost-especially if any module changes are needed later, as other adjacent modules are not disturbed. The uninterrupted system bus is securely integrated within the 35 mm standard mounting rail. Whether 7.5 mm or 15 mm high, the custom-fit rail profiles are easy to install on all TS 35 standard rails in accordance with DIN EN 60715.

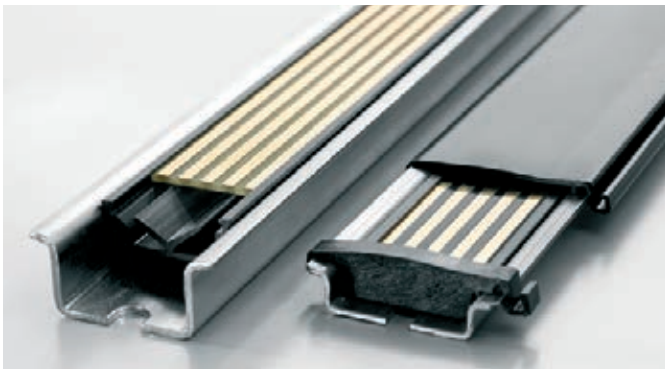

The resistant gold-plated contacts ensure a permanent and reliable contact. The ACT20M modules are simply snapped onto the mounting rail and are automatically in contact with the DIN rail bus.

The supply of 24 V DC to the power rail can be from any one of the auxiliary powered ACT20M modules, when that module is itself externally supplied. This allows the rail to power up to 8 other modules (approximately 400 mA). For powering additional ACT20Ms, a separate Feed-In module can be used.

The ACT20-Feed-In-Basic provides a simple and compact (6 mm width) power supply interface to the rail, for supplying up to 2.5 A (up to 50 x ACT20M modules).



The ACT20-Feed-In-Pro is a more powerful 22.5 mm wide solution. This takes 2 external 24 V DC inputs, and via internal diodes provides a redundant supply to the rail, and an alarm output in the case of input failure.

Rail bus accessories

CH20M BUS-PROFIL TS35x7.5/1000

Support section for bus circuit board



- Support section for TS 35 x 7.5
- Length: 250, 500 or 750 mm

Ordering data

Type	Qty.	Order No.
CH20M BUS-PROFIL TS35x7.5/250	10	1248150000
CH20M BUS-PROFIL TS35x7.5/500	10	1248160000
CH20M BUS-PROFIL TS35x7.5/750	5	1248170000

CH20M BUS-PROFIL TS35x15/1000

Support section for bus circuit board



- Support section for TS 35 x 15
- Length: 250, 500 or 750 mm

Ordering data

Type	Qty.	Order No.
CH20M BUS-PROFIL TS35x15/250	5	1248180000
CH20M BUS-PROFIL TS35x15/500	5	1248190000
CH20M BUS-PROFIL TS35x15/750	5	1248210000

CH20M BUS 4.50/05 AU/1000

Bus PCB



- Bus circuit board for use on TS 35 x 7.5 and TS 35 x 15
- Length: 250, 500 or 750 mm
- Five conductor paths, gold-plated
- Electrical rating: 63 V AC, 5 A/conductor path

Ordering data

Type	Qty.	Order No.
CH20M BUS 4.50/05 AU/250	10	1248220000
CH20M BUS 4.50/05 AU/500	10	1248230000
CH20M BUS 4.50/05 AU/750	5	1248240000

CH20M BUS-ADP TS35/1000

Cover plate



- Cover plate for DIN rail bus
- Length: 250, 500 or 750 mm

Ordering data

Type	Qty.	Order No.
CH20M BUS-ADP TS35/250	10	1248250000
CH20M BUS-ADP TS35/500	10	1248260000
CH20M BUS-ADP TS35/750	5	1248270000

CH20M BUS-AP LI TS35x7.5 & 15

End plate



- End plate for DIN rail bus
- Fits on TS 35 x 7.5 and TS 35 x 15
- left

Ordering data

Type	Qty.	Order No.
CH20M BUS-AP LI TS35x7.5 & 15	50	1193160000

CH20M BUS-AP RE TS35x7.5 & 15

End plate



- End plate for DIN rail bus
- Fits on TS 35 x 7.5 and TS 35 x 15
- right

Ordering data

Type	Qty.	Order No.
CH20M BUS-AP RE TS35x7.5 & 15	50	1193170000

SET CH20M BUS 250MM TS 35X15

Set

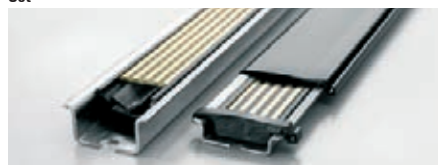

- SET consists of one each of
CH20M BUS 4.50/05 AU/250
CH20M BUS-ADP TS 35/250
CH20M BUS-AP LI TS 35X7.5 & 15
CH20M BUS-AP RE TS 35X7.5 & 15
CH20M BUS-PROFIL TS 35X15/250

Ordering data

Type	Qty.	Order No.
SET CH20M BUS 250MM TS 35X15	1	1335150000

SET CH20M BUS 250MM TS 35X7.5

Set

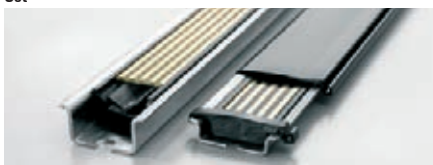

- SET consists of one each of
CH20M BUS 4.50/05 AU/250
CH20M BUS-ADP TS 35/250
CH20M BUS-AP LI TS 35X7.5 & 15
CH20M BUS-AP RE TS 35X7.5 & 15
CH20M BUS-PROFIL TS 35X7.5/250

Ordering data

Type	Qty.	Order No.
SET CH20M BUS 250MM TS 35X7.5	1	1335140000

TS 35x7.5 / TS 35x15

DIN rail

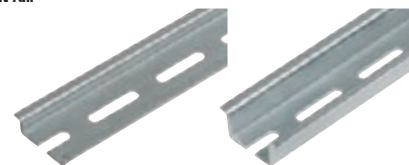

- DIN rail with slot
- Passivated galvanised steel

Ordering data

Type	Qty.	Order No.
TS 35X7.5/LL 1M/ST/ZN	10	0514510000
TS 35X15/LL 1M/ST/ZN	10	0236510000

Power-feed module for the CH20M DIN rail bus

4 A supply with backup supply and error analysis

The power-feed unit ACT20-FEED-IN-PRO-S supplies the devices on the CH20M DIN rail bus with 24 V DC. At the same time, the FEED-IN device reads the group error contact – optionally provided by the installed devices – from the CH20M rail bus and sends a message through the status relay to the external controller. Optionally, two power supplies can be connected as a primary and back-up, to create a redundant 24 V DC source. An installation in Zone 2 / Division 2 is also possible. Three LEDs show the status of the power supply and the error status.

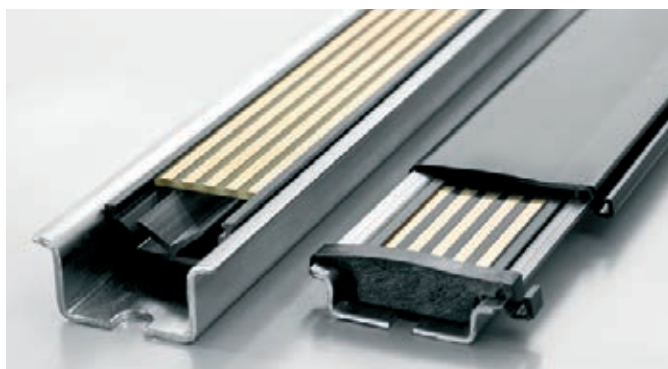

The FEED-IN-PRO can supply a maximum of 4 A to feed up to 120 devices mounted on a CH20M rail bus. Quick identification of errors on the DIN rail bus is through the internal status relay. The FEED-IN-PRO device immediately recognises and displays when a power supply has failed. The supply is then switched automatically to the redundant power supply.



Weidmüller offers a compact and narrow 6 mm feed-in module as an alternative. This feeds the 24 V DC from its field terminals directly to the DIN rail bus. Up to 80 modules can be fed with a maximum available current of 2.5 A.

ACT20 power-feed module

- Distributes the supply onto the busbar
- Compatible with Weidmüller CH20 DIN rail bus
- Optional connection for backup supply
- Approved for use in Ex-Zone 2 / Div. 2
- Monitoring of the supply voltage
- Alarm alerts via the status relay

ACT20-Feed-In-PRO-S

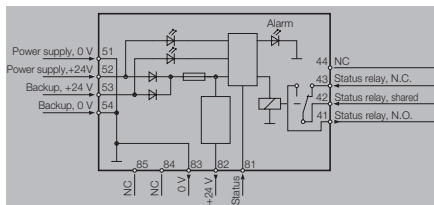

ACT20-Feed-In-BASIC-S

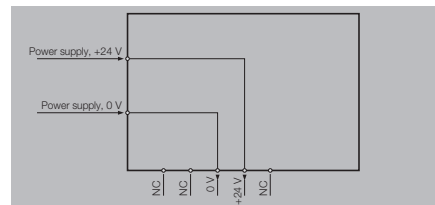

Technical data

Input	
Supply voltage	21.6...26.4 V DC
Input current	Max. 4 A
Trigger level for the power supply	21.6...26.4 V DC
Output, power supply	
Output voltage	Input voltage -0.5 V DC / 4 A
Output power	96 W
Output current	Max. 4 A
Output, status relay in safe zone	
Max. switching voltage, AC / Max. switching voltage, DC	250 V / 30 V
Continuous current	2 A AC / DC
AC power, max.	500 VA / 60 W
General data	
Degree of efficiency	0,976
Ambient temperature	-20 °C...+60 °C
Power consumption	< 2 W
Protection degree	IP 20
Weight	140
Humidity	95 %, no condensation
Approvals	DEKRAATEX; DETNORVER; FMEX; GOSTME25; IECEXDEK

Input	
Supply voltage	21.6...26.4 V DC
Input current	Max. 4 A
Trigger level for the power supply	21.6...26.4 V DC
Fault	< 21 V DC
Output, power supply	
Output voltage	Input voltage -0.5 V DC / 4 A
Output power	96 W
Output current	Max. 4 A
Output, status relay in safe zone	
Max. switching voltage, AC / Max. switching voltage, DC	250 V / 30 V
Continuous current	2 A AC / DC
AC power, max.	500 VA / 60 W
General data	
Degree of efficiency	0,976
Ambient temperature	-20 °C...+60 °C
Power consumption	< 2 W
Protection degree	IP 20
Weight	140
Humidity	95 %, no condensation
Approvals	DEKRAATEX; DETNORVER; FMEX; GOSTME25; IECEXDEK

Input	
Supply voltage	21.6...26.4 V DC
Input current	0.5...2.5 A DC
Trigger level for the power supply	21.6...26.4 V DC
Fault	< 21 V DC
Output, power supply	
Output voltage	Corresponds to the input voltage
Output power	96 W
Output current	Equivalent to input current
Output, status relay in safe zone	
Max. switching voltage, AC / Max. switching voltage, DC	250 V / 30 V
Continuous current	2 A AC / DC
AC power, max.	500 VA / 60 W
General data	
Degree of efficiency	100 %
Ambient temperature	-25 °C...+70 °C
Power consumption	< 2 W
Protection degree	IP 20
Weight	70
Humidity	95 %, no condensation
Approvals	eULus; DETNORVER; FMEX; GL; GOSTME25; IECEXKEM; KEMAATEX

Dimensions	
Clamping range (nominal / min. / max.)	mm ²
Length x width x height	mm
Note	

Screw connection	
2.5 / 0.5 / 2.5	
119.2 / 22.5 / 113.6	
Note	

Screw connection	
2.5 / 0.5 / 2.5	
114.3 / 6.1 / 112.5	
Note	

Ordering data

Screw connection

Type	Qty.	Order No.
ACT20-FEED-IN-PRO-S	1	896550000

Type	Qty.	Order No.
ACT20-FEED-IN-BASIC-S	1	1282490000

Note

Note

Note

Accessories

Note

DIN mounting rail, see Accessories

DIN mounting rail, see Accessories

Signal converter in a terminal format

The MCZ-SERIES signal converters have a slim terminal design and convert, isolate and monitor analogue signals. They have five tension clamp connections. The open side of the housing can be closed using a standard cover plate accessory. The housing has a low height of just 6.3 cm. It also accommodates a cross-connector for reducing the wiring of multiple module's 24 V and 0 V connections. Two WS10/6 markers can be used for labelling. These are available in MultiCard format and can be printed using Weidmüller's professional printing system.

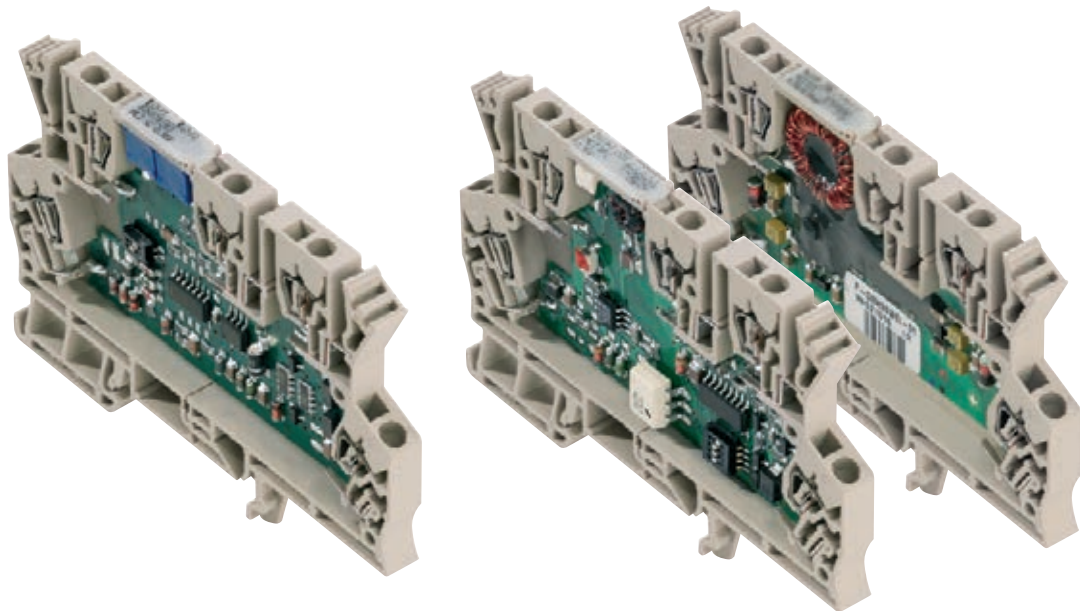

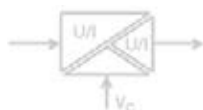

Security

Electrical isolation increases the safety of operations and reduces the risk of facility malfunctions.

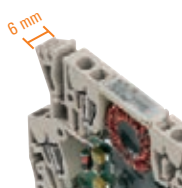





Saves space in the electrical cabinet

High product density (modules only 6 mm wide) reduces space taken on the DIN rail.



Simple wiring

The power supply can easily be bridged from one module to the next using pluggable cross-connections.

	DC/DC passive disconnecter
	PT100 /RTD signal converter
	Frequency signal converter
	Threshold monitoring

MCZ SERIES - DC/DC passive isolator

Input current loop feed

- Passive isolators for galvanic isolation of 0/4...20 mA standard signals.
- The component draws power from the measurement signal and requires no additional auxiliary power
- Low energy consumption, pick-up current of < 100 μ A.
- 2-way isolation

MCZ CCC / ILP

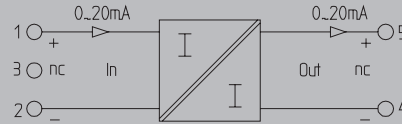
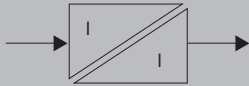

Technical data

Input
Input voltage / Input current
Pick-up current
Voltage drop
Output
Output voltage / Output current
Load impedance, voltage/current
Accuracy
Temperature coefficient
Cut-off frequency (-3 dB)
General data
Configuration
Ambient temperature
Approvals
Insulation coordination
Standards
EMC standards
Insulation voltage

/ 0(4)...20 mA current loop
< 100 μ A
2.5...3 V at 20 mA
max. 10 V / 0...20 mA, 4...20 mA
/ \leq 500 Ω
< 0.1 % of end value
\leq 50 ppm/K of measured value at 0 Ω load resistance
100 Hz
none
-25 °C...+60 °C
CE, CSA, cURus, GOSTME25
DIN EN 60529, DIN EN 61010-1
EN 61000-6
510 V _{eff}

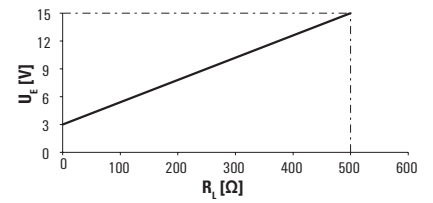

Dimensions	
Clamping range (nominal / min. / max.)	mm ²
Depth x width x height	mm
Note	

Tension-clamp connection
1.5 / 0.5 / 1.5
63.2 / 6

Ordering data

Tension-clamp connection

Type	Qty.	Order No.
MCZ CCC 0-20mA/0-20mA	10	8411190000

Note

Accessories

Note

Cross-connectors for power supplies and markers: refer to Accessories

RTD 2-/3-conductor converter

Output-loop powered

- RTD signal converter for galvanic isolation and conversion of PT100 signals
- The component draws power from the output circuit and requires no additional auxiliary power
- 2-way isolation

MCZ PT100/3 CLP / OLP

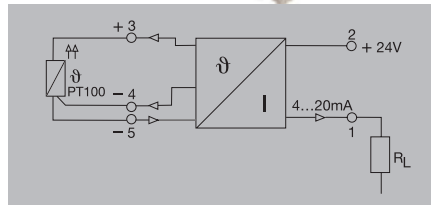
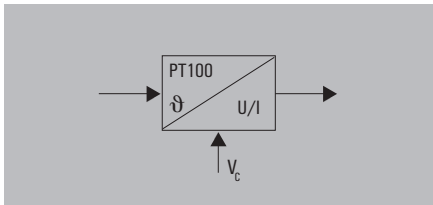

Technical data

Input
Sensor
Sensor supply
Output
Output current
Load impedance, voltage/current
General data
Configuration
Ambient temperature / Storage temperature
Accuracy
Approvals
Standards
EMC standards

PT100/2-/3-wire (in compliance with IEC 751)
0.8 mA / 9...30 V DC
4...20 mA (current loop)
/ ≤ 600 Ω
none
-25 °C...+50 °C / -25 °C...+85 °C
Typical 0.2%, max. 0.5% of FSR
CE; CSA; cURus; GOSTME25
DIN EN 50178, DIN EN 61000-4-2
EN 61000-6

Dimensions	
Clamping range (nominal / min. / max.)	mm ²
Depth x width x height	mm
Note	

Tension-clamp connection
1.5 / 0.5 / 1.5
63.2 / 6 /

Ordering data

0...100 °C	Tension-clamp connection
0...120 °C	Tension-clamp connection
0...150 °C	Tension-clamp connection
0...200 °C	Tension-clamp connection
0...300 °C	Tension-clamp connection
-50...+150 °C	Tension-clamp connection
-40...+100 °C	Tension-clamp connection

Type	Qty.	Order No.
MCZ PT100/3 CLP 0...100C	10	8425720000
MCZ PT100/3 CLP 0...120C	10	8483680000
MCZ PT100/3 CLP 0...150C	10	8604420000
MCZ PT100/3 CLP 0...200C	10	8473010000
MCZ PT100/3 CLP 0...300C	10	8473020000
MCZ PT100/3 CLP -50C...+150C	10	8473000000
MCZ PT100/3 CLP -40C...100C	10	8604430000

Note

Accessories

Note

Cross-connectors for power supplies and markers: refer to Accessories

MCZ SERIES - frequency signal isolator

DC/f converter

The analogue input signal is converted into a configurable frequency signal. Thus analogue signals can be read by the PLC's counter inputs.

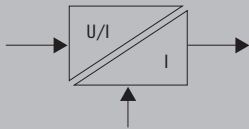

MCZ VFC

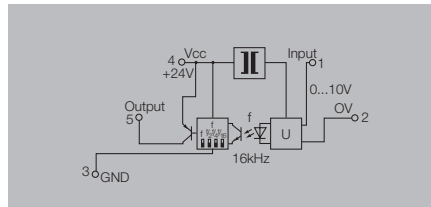

MCZ CFC

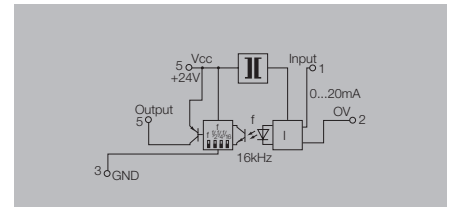

Technical data

Input	
Input voltage / Input current	
Input resistance, voltage/current	
Voltage drop	
Output	
Output frequency	
Output level	
Output current	
Accuracy	
Temperature coefficient	
Status indicator	
General data	
Configuration	
Supply voltage	
Current consumption	
Current-carrying capacity of cross-connect.	
Ambient temperature	
Approvals	
Insulation coordination	
Standards	
EMC standards	
Rated voltage	
Impulse withstand voltage	
Insulation voltage	
Overvoltage category	
Pollution degree	
Clearance & creepage distances	

0...10 V /
100 kΩ /
0...1/ 4/ 8/ 16 kHz
PNP, Ub-0.7 V
max. 20 mA
0.2% of FSR
≤ 250 ppm/K
LED, pulsing
DIP switch
24 V DC ± 10 %
14 mA without load
≤ 20 A
0 °C...+50 °C
CE, GOSTME25
DIN EN 50178
EN 55011, EN 61000-6
100 V
1.5 kV
1 kV DC
III
2
≥ 1.5 mm

/ 0...20 mA
/ 50 Ω
1 V at 20 mA
0...1/ 4/ 8/ 16 kHz
PNP, Ub-0.7 V
max. 20 mA
0.2% of FSR
≤ 250 ppm/K
LED, pulsing
DIP switch
24 V DC ± 10 %
14 mA without load
≤ 20 A
0 °C...+50 °C
CE, GOSTME25
DIN EN 50178
EN 55011, EN 61000-6
100 V
1.5 kV
1 kV DC
III
2
≥ 1.5 mm

Dimensions	
Clamping range (nominal / min. / max.)	mm ²
Depth x width x height	mm
Note	

Tension-clamp connection	
1.5 / 0.5 / 1.5	
63.2 / 6	

Tension-clamp connection	
1.5 / 0.5 / 1.5	
63.2 / 6	

Ordering data

Tension-clamp connection

Type	Qty.	Order No.
MCZ VFC 0-10V	10	8461470000

Type	Qty.	Order No.
MCZ CFC 0-20mA	10	8461480000

Note

Note

Note

Accessories

Note

Cross-connectors for power supplies and markers: refer to Accessories

Cross-connectors for power supplies and markers: refer to Accessories

Transistor output

- 2 digital outputs
- Monitoring of upper and lower limit values
- 3 selectable input ranges: 300 mV...10 V, 30 mV...1 V, 10 mV...100 mV

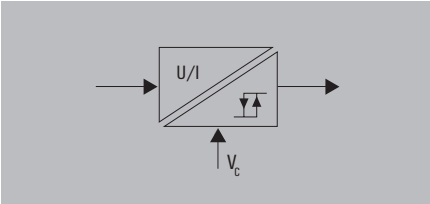

MCZ SC 0...10 V

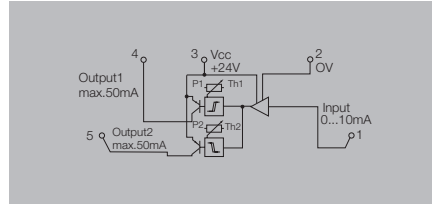

MCZ SC 0...20 mA

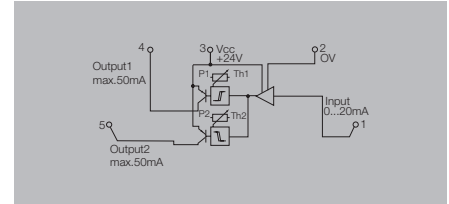

Technical data

Input	
Input voltage / Input current	0...10 V /
Input resistance, voltage/current	60 kΩ /
Voltage drop	
Output	
Contact assembly	double switch output PNP
Function	$U_{in} < U_{Th1}$: output 1 active / $U_{in} > U_{Th2}$: output 2 active
Switching thresholds	Via 2 potentiometers (12 turns)
Hysteresis	1% of adjusted final value
Switching current	50 mA - per channel (voltage drop at transistor: < 1.2 V at 50 mA)
Step response time	< 250 μs (switching threshold at 90% of max. input signal; $R_i \leq 1$ kΩ)
Cut-off frequency (-3 dB)	100 Hz
Temperature coefficient	max. 250 ppm/K
General data	
Configuration	Potentiometer
Supply voltage	24 V DC \pm 20 %
Ambient temperature	0 °C...+50 °C
Approvals	CE, CSA, cURus, GOSTME25
Insulation coordination	
Standards	DIN EN 50178
EMC standards	EN 55011, EN 61000-6

Input voltage / Input current	0...10 V /
Input resistance, voltage/current	60 kΩ /
Voltage drop	
Output	double switch output PNP
Function	$U_{in} < U_{Th1}$: output 1 active / $U_{in} > U_{Th2}$: output 2 active
Switching thresholds	Via 2 potentiometers (12 turns)
Hysteresis	1% of adjusted final value
Switching current	50 mA - per channel (voltage drop at transistor: < 1.2 V at 50 mA)
Step response time	< 250 μs (switching threshold at 90% of max. input signal; $R_i \leq 1$ kΩ)
Cut-off frequency (-3 dB)	100 Hz
Temperature coefficient	max. 250 ppm/K
Configuration	Potentiometer
Supply voltage	24 V DC \pm 20 %
Ambient temperature	0 °C...+50 °C
Approvals	CE, CSA, cURus, GOSTME25
Standards	DIN EN 50178
EMC standards	EN 55011, EN 61000-6

Input voltage / Input current	/ 0.5...20 mA
Input resistance, voltage/current	/ 50 Ω
Voltage drop	1 V
Output	double switch output PNP
Function	$I_{in} < I_{Th1}$: Output 1 active / $I_{in} > I_{Th2}$: Output 2 active
Switching thresholds	Via 2 potentiometers (12 turns)
Hysteresis	1% of adjusted final value
Switching current	50 mA - per channel (voltage drop at transistor: < 1.2 V at 50 mA)
Step response time	< 250 μs (switching threshold at 90% of max. input signal; $R_i \leq 1$ kΩ)
Cut-off frequency (-3 dB)	100 Hz
Temperature coefficient	max. 250 ppm/K
Configuration	Potentiometer
Supply voltage	24 V DC \pm 20 %
Ambient temperature	0 °C...+50 °C
Approvals	CE, CSA, cURus, GOSTME25
Standards	DIN EN 50178
EMC standards	EN 55011, EN 61000-6

Dimensions	
Clamping range (nominal / min. / max.)	mm ²
Depth x width x height	mm
Note	

Tension-clamp connection	
Clamping range (nominal / min. / max.)	1.5 / 0.5 / 1.5
Depth x width x height	63.2 / 6
Note	

Tension-clamp connection	
Clamping range (nominal / min. / max.)	1.5 / 0.5 / 1.5
Depth x width x height	63.2 / 6
Note	

Ordering data

Tension-clamp connection

Type	Qty.	Order No.
MCZ SC 0-10V	10	8260280000

Type	Qty.	Order No.
MCZ SC 0-20MA	10	8227350000

Note

Note

Note

Accessories

Note

Cross-connectors for power supplies and markers: refer to Accessories

Cross-connectors for power supplies and markers: refer to Accessories

Signal converters

Signal converters	Universal signal converters - Overview	D.2
	ACT20C - Overview	D.4
	ACT20C - Network-compatible signal converter	D.7
	ACT20P - Overview	D.8
	ACT20P - Signal splitter	D.11
	ACT20P - Signal converter	D.12
	ACT20P - Bridge measuring transducer	D.16
	WAVESERIES - Overview	D.18
	WAVESERIES - Universal signal converter	D.22
	WAVESERIES - DC/DC 3-way isolator, configurable	D.26
	WAVESERIES - DC/DC 3-way isolator	D.28
	WAVESERIES - DC/DC 2-way isolator	D.38
	WAVESERIES - DC/DC passive isolator	D.40
	WAVESERIES - Temperature measuring transducer	D.44
	WAVESERIES - Frequency signal isolator/converter configurable	D.54
	WAVESERIES - Current measuring transducer	D.56
	WAVESERIES - Voltage measuring transducer	D.60
	Isolating converter for serial interfaces	D.62

Signal converters

Weidmüller analogue conditioners and monitoring modules are offered in touch-safe IP 20 housings and with space-saving DIN mounting.

This product line includes: passive and active isolation amplifiers for analogue current and voltage signals; measurement isolators for measuring temperatures, resistances, frequencies, AC/DC currents and voltages; and universally-configurable signal isolating converters with integrated threshold monitoring.

Weidmüller wide product range covers all the functions for isolating, converting and monitoring analogue signals. These products can therefore be used in practically all industrial measurement applications to safeguard the basic functionality between field signals and post-processing systems. A comprehensive line of accessories is also available for the analogue signal converter product line. These include pluggable cross-connectors, markers, and configuration adapters for the software-programmable products.

Features

- Can handle a variety of measurements
- Standard analogue signals on the output side
- Configurable options
- Stand-alone, pluggable connection mechanism – screw or tension clamp
- Tool-free installation
- Minimal commissioning needed - often with no calibration.
- Minimal wiring effort – with pluggable ZQV 2.5N cross-connector
- Excellent functionality
- Clear type designations makes selection easy
- High level galvanic isolation
- International approvals





ACT20C



ACT20P



WAVESERIES

Your process requires the utmost attention

Our new ACT20C signal conditioners support you in achieving this

Many process parameters in your system are handled by your control system, which shows you the current status of your process. Even so, do you have a full overview of critical system states? And this at all times, at every location, and with the recent system history?

With the ACT20C, you receive accurate information on the status of the sensors, signal processing and cabling. Data can be called up and will depending on your individual communications infrastructure. This comprehensive overview allows you to accurately analyse errors and faults, and initiate targeted actions taken by system operators and maintenance personnel. By doing so, this technology contributes to ensuring reliable system operation.



D



ACT20C signal conditioner with Ethernet interface

Comprehensive process transparency is provided by the transfer of diagnostics information, signals and data

You would like more process transparency for your systems. We support you with signal conditioners that supply you with precise information via our Ethernet interface. Let's connect.

To be able to control systems and processes optimally, you require a constant flow of information on the current states of individual applications, devices and functions.

Our ACT20C signal conditioner not only monitors the signal conversion, but also communicates precise information on device status, signals and data directly to connected computer and control systems.

Our Ethernet interface enables an event-controlled transfer of diagnostics information, which in turn supports the elimination of faults in, for example, plant operation.



Universal signal conversion

Can be used in a multitude of applications thanks to customer and application specific defined conversion methods with just one single module.

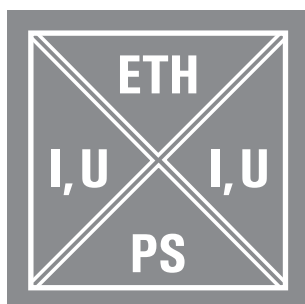

Simple operation and configuration

Software supported configuration allows a fast application of settings and simple operation.



Simple remote access

Continuous monitoring of device and system functions, simple and affordable integration of existing Ethernet networks.



Detailed analysis and presentation of core process parameters

The ACT20C supplies key parameters and historical data, independent of the location

Thanks to the ACT20C, Weidmüller is now the first to offer a solution which supplies you with extensive diagnostic and status information without the need to deal with the complexity of field bus systems.

The isolating converters are based on the proven, robust technology of transferring analogue signals to the DCS system. Various signal sources and field devices can be connected to the input side of the isolating converters. As a result of this, the ACT20C can be configured for the user-defined processing of current, voltage and transmitter signals. Access is accomplished via a service interface on

the front panel or via the Ethernet, and performance is ensured through the manufacturer-independent FDT/DTM software platform. To work with this platform, Weidmüller provides the WI-Manager universal FDT frame application.

Data collected in the ACT20C is made available over the Ethernet via Modbus TCP. Depending on the communications infrastructure, you can make this data available to your SCADA system within your network, and you can also access it via the Internet from any location using an industrial Ethernet router.

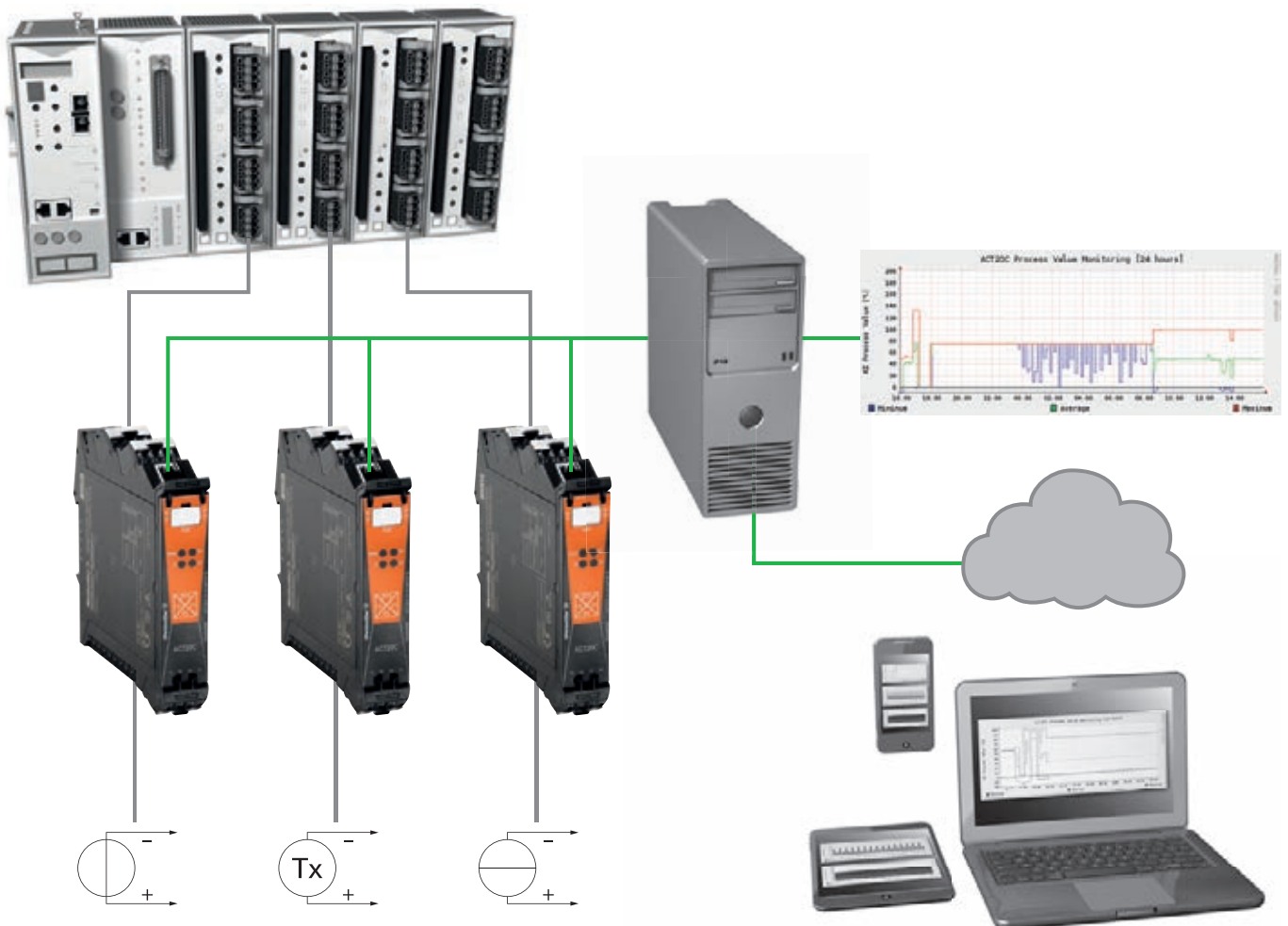

Network-ready signal converter for DC voltage and current signals

Network-compatible signal converter with Ethernet

- Scalable current or voltage input
- Current or voltage output
- Limit-value monitoring with parameterisation options
- Diagnostics on device status, signals and line faults via Modbus
- PC configuration with FDT/DTM software, download link at www.weidmueller.com

ACT20C-AI-AO-MTCP-S

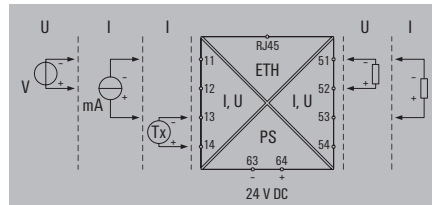

Technical data

Input	
Input current	0...20 mA, 4...20 mA
Input voltage	0(2)...10 V
Sensor supply	> 17 V DC at 20 mA
Output	
Output current	0...20 mA, 4...20 mA
Output voltage	0...10 V
Load impedance current	≤ 500 Ω
Load impedance voltage	≥ 10 kΩ
Signal processing	
Transfer functions	Linear, Inverse
Limit-value monitoring	Process alarms with adjustable delay and hysteresis
Condition Monitoring	Process value: sensor value, output value
Diagnostics	Device status, Short-circuit (input/output), Cable break (input/output), Overload (sensor/output)
General data	
Supply voltage	24 V DC ± 25 %
Power consumption	≤ 3,5 W
Accuracy	< 0.15% end value (+ 0.05% > 55°C), Current: 1 uA / 30 uA (+ 10 uA > 55°C), Voltage: 1 mV / 15 mV (+ 5 mV > 55°C)
Temperature coefficient	≤ 0.01 % / °C
Ambient temperature (operational)	-20 °C...+70 °C
Storage temperature	-20 °C...+85 °C
Humidity	0...95 % (no condensation)
Protection degree	IP 20
Insulation coordination	
Galvanic isolation	4-way isolator, between input / output / power supply / Ethernet
Rated voltage / test voltage: input/output to output/input / supply/ Ethernet interface	300 V _{rms} / 1.7 kV _{rms} on secondary electric circuits, reinforced insulation
Rated voltage / test voltage: Ethernet interface to supply / functional earth to supply / Ethernet interface	31.2 VDC / 0.9 kV _{rms} on secondary electric circuits, basic insulation
Rated voltage / test voltage: functional earth to input / output	300 V _{rms} / 1.1 kV _{rms} on secondary electric circuits, basic insulation
Pollution degree	2
Communication	
RJ45 ports	10/100BaseT(X), auto negotiation
Interface	RJ45: female-female, Cat.5 to 100 MHz, Jack plug for CBX200
Addressing	DHCP or manual adjustment
Protocol	FDT/DTM, Modbus/TCP
Configuration	FDT/DTM (Ethernet or service interface)
Approvals	
Standards	DIN EN 61010-1, EN 61326-1:2006
Recommendations	Namur NE43, Namur NE44, Namur NE107
Dimensions	
Clamping range (nominal / min. / max.)	2.5 / 0.5 / 2.5 mm ²
Depth x width x height / Weight	113.6 / 22.5 / 180 mm
Note	

Ordering data

Type	Qty.	Order No.
ACT20C-AI-AO-MTCP	1	1334490000

Can be integrated in HART® communication

Signal converters are suitable for HART®, transparent communication.



Reliable connection

Individually customisable protection against mismatching.



Rapid device replacement

Practical release lever for simple removal of the female connector.



More space in the cabinet

Two channels measure a mere 12.5 mm wide.



Variants for different applications

The range of products is rounded off by the intrinsically safe ACT20X signal converter and the high-performance ACT20M signal converter, which is just 6 mm across.





Reliable connection

Individually configurable protection against mismatching with release lever

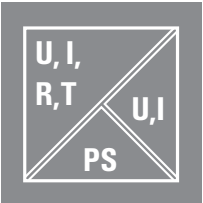

High level of galvanic isolation

The galvanic isolation of 2 kV (300 V rated voltage) ensures high process reliability



Simple signal conditioning

Devices configured for converting standard sensor signals to standard DC signals.



Signal splitter



Signal converter

ACT20P – Selection table

D

		Output						
		Current						
		0 ... 20 mA 1-channel	4 ... 20 mA 1-channel	2 x 0 ... 20 mA 2-channel / splitter	2 x 4 ... 20 mA 2-channel / splitter			
Input	Current	Power supply	Function					
	0 ... 20 mA	24 V DC and rail bus	Current	ACT20P-CI-CO-S				
			Current			ACT20P-CI-2CO-S	ACT20P-CI-2CO-S	
		Output Loop Powered	Current		ACT20P-CI1-CO-OLP			
		2 x 0 ... 20 mA	Output Loop Powered	Current			ACT20P-2CI-2CO-12	
			Input Loop Powered	Current			ACT20P-2CI-2CO-ILP	
			24 V DC	Current			ACT20P-2CI-2CO-12	ACT20P-2CI-2CO-12
	4 ... 20 mA	24 V DC and rail bus	Current	ACT20P-CI-CO-S	ACT20P-CI-CO-S			
			Current			ACT20P-CI-2CO-S	ACT20P-CI-2CO-S	
		24 V DC	Current			ACT20P-2CI-2CO-12	ACT20P-2CI-2CO-12	
	2 x 4 ... 20 mA	24 V DC	Current			ACT20P-2CI-2CO-12	ACT20P-2CI-2CO-12	

Note: *) available from July 2013

ACT20P - Signal converter

Signal converter

- Isolation of DC signals
- Passive transmitter or active current input
- 3-way isolation
- HART® - transparent

ACT20P-CI-CO

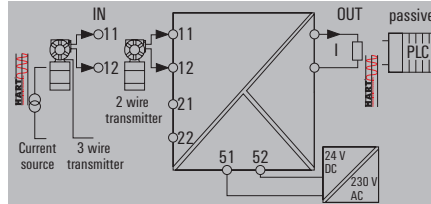

Technical data

Input

Input signal
Input current
Voltage drop, current input
Voltage drop

Output

Output current
Load impedance current

General data

Configuration
Supply voltage
Accuracy
Step response time
Current consumption
Temperature coefficient
Ambient temperature

Insulation coordination

EMC standards
Insulation voltage
Test voltage
Impulse withstand voltage
Pollution degree
Overvoltage category

2-/3-wire transmitter, HART digital signal

0...20 mA, 4...20 mA

≥ 17 V @20 mA

≤ 1 V

0...20 mA, 4...20 mA

≤ 550 Ω

none

24 V DC ± 20 %

< 0.1 % of end value

≤ 0,5 ms

60 mA

80 ppm/K

-20 °C...+60 °C

EN 61010-1:2011, UL 61010-1, EN 61326-1

2 kV inputs / outputs / power supply

300 V

4 kV (1.2/50 μs)

2

III

Dimensions

Clamping range (nominal / min. / max.) mm²
Depth x width x height mm

2.5 / 0.5 / 2.5

114 / 12.5 / 117.2

Note

Ordering data

Type	Qty.	Order No.
ACT20P-CI-CO	1	7760054114

Note

Accessories

Note

ACT20P Strain gauge transmitter

The ACT20P Bridge converts load cell/strain gauge measurement signals to standard analogue signals.

The ACT20P family offers the customer precise and functional signal converters in a compact design. The ACT20P Bridge is the first product from this new line of signal converters.

Load cells, with integral strain gauges, are used for weighing and load measurements throughout factory and process automation, in such applications as batch and recipe control, silo contents for granular products, bag weighing, engine strain measurements, and tank level.

The strain gauges, within the load cell, are film resistors in a measurement bridge network, which deform with load changes and create a varying millivolt output from the bridge. The ACT20P Bridge reads these signals and converts them to a standard signal 0(4) – 20 mA or 0 – 10 V.

The high input to output isolation provided protects the control PLC against signal line interference. A digital input representing the “empty” condition of the container (tare function) is a standard feature which zeroes the output of the ACT20P Bridge.

Features

- Adjust to load cells using push button
- Easy tare function using the integrated control input
- Intelligent pluggable connection method
The release lever simplifies maintenance and enables the connection to be unplugged without any wire damage.
- Integrated captive coding with the unique “auto-set” function



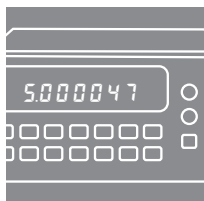

Exact measurement

The input with 6-conductor connection and very high accuracy (0.05 % of the measurement range) enables precise signal processing.

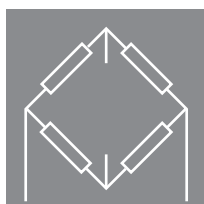

Conversion

Conversion of the bridge voltage in standardised analogue signals.



Tare calibration

Simple calibration of the empty (tare) weight can be done on-site by using the button under the front plate or with an external connection via a PLC output.



On-site calibration

Simple and reliable calibration on-site. The ACT20P Bridge is adjusted to the different load cells by means of a push button behind the hinged panel.



Protection

Protection against noise from the field. The 3-way isolation separates the input, the voltage supply and the output with 5.7 kV isolation voltage.



Strain gauge transmitter

ACT20P Bridge measuring transducer

Bridge measuring transducer for reading from load cells

General

The ACT20P Bridge is a DIN rail mounted, signal conditioner for industrial measuring bridges. It provides a precise excitation voltage for the bridge, and converts the input measurement to an isolated current/voltage signal. Bridge measuring transducers are used for various measurements like weight, force, tension, pressure, torque, and deflection.

Bridge excitation supply

Voltage sense connections are provided so that the excitation voltage can be measured at the bridge. Known as 'remote sensing' this method compensates for cabling and contact resistance errors. It is recommended for all new installations or where an upgrade is possible. Remote sensing wiring requires three twisted pairs.

TARE adjustment

The installed strain gauge is normally subjected to an initial load independent of the measurement taken. The TARE connection allows you to correct for this initial loading by operating a switch. Alternatively there is a button on the front of the unit (under the front cover) that performs the same function. Press for two seconds to correct for the initial load (the 'CAL HI' LED will light for one second).

Gauge factor

Every strain gauge has a 'gauge factor' which gives the output voltage at full-scale for a one volt excitation voltage (given in mV/V). You multiply this by the bridge excitation voltage to get the output voltage when the gauge is fully loaded. For example, a load cell with 10 V excitation and 2 mV/V gauge factor will give 20 mV when fully loaded. The meaning of a 20 mV output depends on the type of the strain gauge. If it was designed to measure 0-1000 Kg then 20 mV indicates a 1000 Kg load.

Setup

The ACT20P Bridge has internal switch settings that determine the excitation voltage (5 V or 10 V) and Input range limits. Select the appropriate settings from the table below. Once you have set the DIP switches, you simply calibrate the unit to the input and output range for your application.

Calibration

There are three options for calibrating the ACT20P Bridge:

- Kalibrierung über einen Messbrückensimulators (Bench calibrate using a bridge simulator (if you know the gauge factor)
- Calibrate on-site by loading the actual installed strain gauge
- Bench calibrates using a mV source (if you know the gauge factor).

For more information please read the manual from the web page: www.weidmueller.com

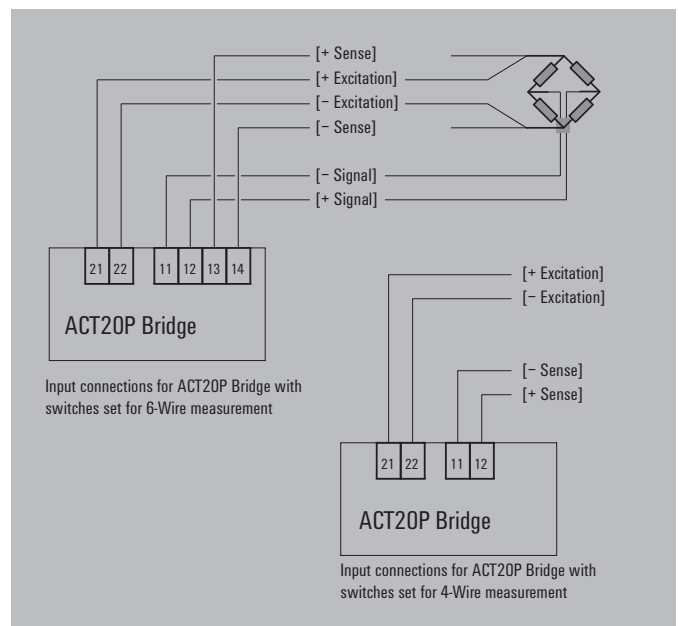

Configurable

Bridge measuring transducer for reading from load cells

- 3-way isolation
- Supply for measuring bridges up to 4 x 350 Ω
- Simple calibration of the tare weight using external switch or PLC input
- Input and output ranges adjustable via DIP switch

ACT20P-BRIDGE-S

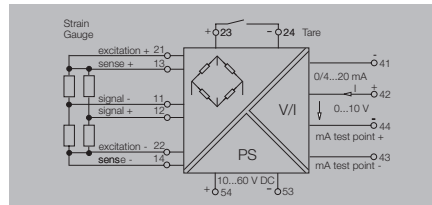

Technical data

Input	
Type	
Bridge sensitivity	
Input measurement range	
Input resistance	
Sensor supply	
Bridge supply voltage	

Output	
Type	
Output voltage / Output current	
Load impedance, voltage/current	

General data	
Configuration	
Supply voltage	
Power consumption	
Linearity	
Repeat accuracy	
Humidity	
Temperature coefficient	
Long-term drift	
Step response time	
Ambient temperature	
Approvals	

Insulation coordination	
Standards	
EMC standards	
Rated voltage	
Impulse withstand voltage	
Pollution degree	
Overvoltage category	
Insulation voltage	

Resistance measuring bridge
1.0 mV / V to 5.0 mV / V
± 10 mV / ± 20 mV / ± 30 mV / ± 50 mV (adjustable)
> 1 MΩ
120 mA @ 10 V (= 4 x 350 Ω bridge resistors)
5 V or 10 V

Voltage and current output (configurable)
0...11 V (adjustable) / 0...22 mA (adjustable)
600 Ω / ≤ 600 Ω

DIP switch
10...60 V DC
3 W @ 24 V DC
Typically ± 0.05 % of signal range
± 0.05% of signal range
10...90 % (no condensation)
typ. 0.005 % / °C
0.1 % / 10.000 h
< 400 ms (10...90 %)
-40 °C...+70 °C
GOSTME25

DIN EN 61010-1, DIN EN 61000-4-2
EN 61326
300 V _{eff}
4 kV (1.2/50 μs)
2
III
5.7 kV (input / output, input / supply)

Dimensions	
Clamping range (nominal / min. / max.)	mm ²
Depth x width x height	mm

Ordering data

Screw connection

Screw connection	
2.5 / 0.5 / 2.5	
/ 22.5 / 113.6	

Note

Accessories

Note

Front panel DIP Switch settings

Switch	Action if On	Action if Off
1	10 V Excitation	5 V Excitation
2	mA Output	Voltage Output
3	10 mV Span	Turn off for other ranges
4	20 mV Span	
5	30 mV Span	
6	50 mV Span	
7	4-wire Measurement	6-wire Measurement
8		

Connections

Terminal	Signal	
11	Signal -	Input signal
12	Signal +	
13	Sense +	Bridge Excitation Voltage
14	Sense -	
21	Excitation +	
22	Excitation -	
23	Tare +	External Tare switch
24	Tare -	
41	mA Output -	Output signal
42	Output +	
43	mA-Test Point -	
44	Voltage Output -	
44	mA-Test Point +	Power Supply
54	+	
53	-	

WAVESERIES – Signal converters

Isolation and conversion of analogue signals – enclosed in a rail-mounted WAVEBOX housing

WAVESERIES products are well suited for users seeking an analogue signal conversion solution. Weidmüller’s WAVESERIES integrates a wide variety of functions into a compact, space-saving design. This product line covers a broad range of products suitable for many different analogue signal conditioning applications.

- Passive isolation amplifier for standard analogue signals
- Active isolation amplifier for standard analogue signals with 2-way or 3-way isolation
- Isolating signal converters for temperature (RTDs / thermocouples), resistance, potentiometer, frequency, AC/DC currents up to 60 A, and AC voltages up to 450 V.
- Measuring transducer for measuring AC currents up to 500 A
- Signal converters for all common input signals, with configuration (either DIP switch or with software)
- Signal converters with analogue and relay outputs, fully configurable via interface and software

D



Service

No tools are required when removing the PCB from the housing. Simply push in the locking clips on the head piece and then pull out the upper section along with the connections and the PCB.

Saves time

The ZQV 2.5N cross-connector can be used to connect the housing together in order to bridge the power supply between the modules.



Security

You must ensure the presence of “protective separation” in accordance with EN50 178. The WAVESERIES products are able to fulfil these requirements completely.





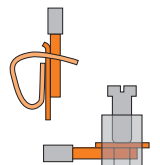

Flexibility





The BLZ/ BLZF pluggable screw and tension-clamp connections offer you the best flexibility. Coding elements can be used (without loss of poles) to make sure that the wrong plug cannot be inserted.



Protection

The WAVEBOX housing is made from recyclable plastics. It is available in widths of 12.5, 17.5, 22 or 45 mm. Practically no tools are required during installation. All requirements and EMC are met. The integrated ventilation slits ensure that sufficient heat dissipation takes place.

	Universal signal converter
	3-way isolator, configurable
	3-way isolator
	2 way isolator, Output Loop Powered
	Passive Isolators, Input and Output Loop Powered
	Temperature transmitters

	Frequency converters
	Current monitoring
	Voltage monitoring
	Bridge measurement isolator/ converter
	Serial interface isolation converter

WAVE TTA – one module fits all ...

In the case of signal processing this is a big benefit. The maintenance engineer who hasn't got the right spare isolator or transmitter, and has to run part of the plant on manual control for a day or two before the replacement arrives understands this. It wastes his time and money. So Weidmüller has designed a signal processor with unique flexibility.

In one module the Wave TTA is an intelligent signal

- Isolator
- Convertor
- Transmitter
- Lineariser
- Trip-amplifier

The new WAVE TTA is a "universal" Transmitter Trip-Amplifier. It is part of Weidmüller's well-established WAVESERIES family of analogue signal conditioners, which are widely used in process and factory automation applications.

The TTA is unique. It has a combination of high performance and exceptional configurability. Designed for process industry applications, the TTA will work accurately and stably over a wide ambient temperature range, and over a wide supply voltage range, and with most types of sensor inputs. For 2-wire current transmitters 24 V DC power is provided. Alternatively the TTA can be a passive input for the current source.

Most commonly used temperature sensors and DC inputs are accepted, and the TTA also allows the user to define his own characteristics, so special sensor types and linearisation can easily be accommodated.

To help simplify installation and loop commissioning, test terminals are provided to permit input and output signal checks without removing cabling.

For linearised and/or isolated analogue outputs, the user has a choice of standard or variable DC milliamps and voltage ranges. These can be set as either direct or reverse acting. The user can also select upscale or downscale output in the event of a sensor break or an open circuit in the input.

The TTA provides 2 changeover-relay outputs which can be independently set, for use as high and low level alarms or control points.

Configuring the versatile TTA to change input and output parameters is simple, and performed from a computer via an interface (CBX200 USB).

Powering the TTA is flexible too. When the auxiliary supply is anything between 18 and 264 V (AC or DC), one module can take it.

Physically, the TTA comes in a black WAVESERIES housing with a flammability class V0 acc. UL 94, for mounting on TS 35 DIN rail. Pluggable connectors, allow screw or tension clamp wiring. A screwdriver-releasable front flap gives access to the configuration interface socket.





The free software TTA-Set allows fast and uncomplicated configuration of the WAVE TTA . Easily adjustable measurement window, transmit functions and switching thresholds, as well as different thresholds and alarms for faults.

Universal input signals

- Temperature signals (such as RTDs), One module integrates thermocouples and potentiometers, frequency transmitter, DC voltage signals and DC current signals.

Current source or loop powered input

- For DC current inputs the TTA can be used with either a passive input, or provide power for a two-wire transmitter.

Wide AC/DC power input (18-264 V AC/DC)

User-definable characterisation

- If none of the standard input linearisation options suit the sensor, a special curve can easily be created.

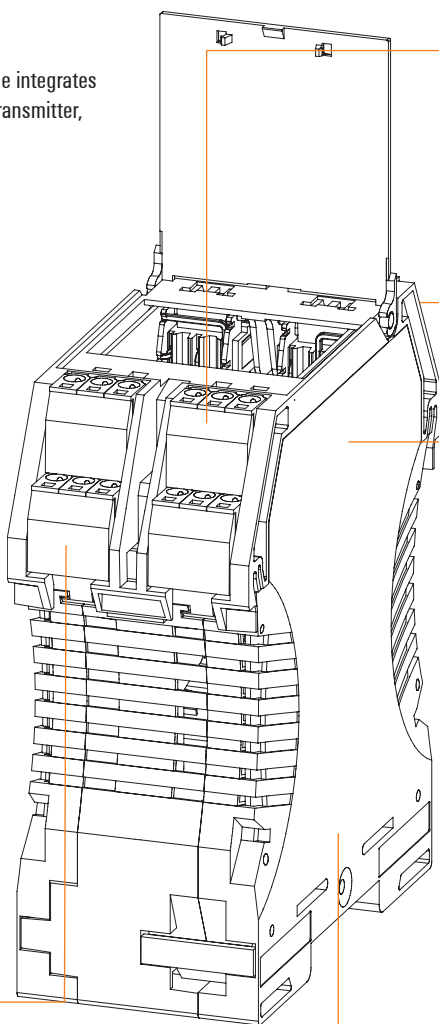

Inputs & outputs configurable via computer

- The range of configurability of the TTA is remarkable – and made easy using TTA SET software, in conjunction with the CBX200 USB interface.

Both analogue and relay outputs

- In one module the TTA integrates adjustable alarm or control outputs from mechanical relays, as well as it's proportional analogue output.

Wide ambient temperature range (-40 to 70 °C)

- Mounting the TTA outside in the field is no problem. It's ambient temperature range means it can also be field enclosure mounted.

High accuracy and temperature stability

- The Wave TTA offers superior performance and minimises losses for data acquisition systems, with its output accuracy typically < 0.1 %, and temperature stability < 0.01 %/K

Milliamp signal testing without removing cables

- The current and voltage inputs can be tested using a supplemental test contact without loosening the existing wiring.

UL Class I Div.2 and ATEX Zone 2 approvals

WAVE TTA

- Input and outputs can be configured on PC with the TTA-SET software, download at www.weidmuller.com
- Universal input signals
- Loop-powered or passive input
- Pluggable connection terminals

WAS6 TTA / WAZ6 TTA

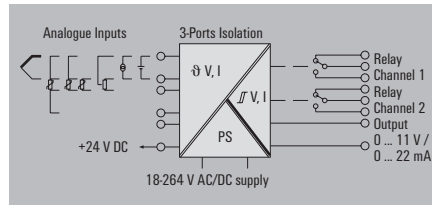

Technical data

Input	
Sensor	
Potentiometer	
Resistance	
Input frequency	
Input voltage	
Input current	
Sensor supply	
Output analogue	
Output voltage	
Output current	
Load impedance, voltage/current	
Signal output	
Transmit function	
Output digital	
Type	
Switching voltage AC, max. / DC, max.	
Continuous current	
General data	
Configuration	
Supply voltage	
Power consumption	
Accuracy	
Temperature coefficient	
Ambient temperature / Storage temperature	
Step response time	
Humidity	
Approvals	
Insulation coordination	
Standards	
EMC standards	
Rated voltage	
Impulse withstand voltage	
Pollution degree	
Overvoltage category	
Clearance & creepage distances	
Insulation voltage	
Dimensions	
Clamping range (nominal / min. / max.)	mm ²
Depth x width x height	mm
Note	

Thermocouples: B, E, J, K, L, N, R, S, T (IEC 60584), PT100, PT1000, (EN 60571) Ni100, Ni1000, (JIS1604), Cu10, Cu25, Cu50, Cu100 (DIN 43760) 2-/3-/4-wire	
100 Ω...100 kΩ	
10 Ω...5 kΩ	
2 Hz...100 kHz	
-200...500 mV (min. 4 mV span), -20...50 V DC (min. 0.5 V span)	
-20...50 mA (min. span 0.4 mA)	
24 V DC / 22 mA	
Adjustable between -10...+10 V (min. span of 2.5 V)	
Adjustable between 0...20 mA (min. span of 5 mA)	
> 10 kΩ @ 0...10 V / > 20 kΩ @ -10...+10 V / < 700 Ω	
direct or inverted	
Linear, x ^{1/2} , x ^{3/2} , x ^{5/2} or user-defined curve (101 points)	
2 x 1 C0 contact (hard gold-plated)	
250 V / 30 V	
3 A AC / 2 A DC	
TTA Set Software	
18...264 V AC/DC	
< 3,5 W	
< 0.1 % span (DC, RTD); 0.2 % span (or 1 °C) + CJ failure	
< 0.1 % / K (DC, RTD); < 0.1 % FSR / K + CJ error 0.07 °C/K (thermocouples)	
-40 °C...+70 °C / -40 °C...+85 °C	
50 ms...1 sec (RTD, mV inputs), 110 ms...1 sec (V, mA inputs)	
5...95 %, no condensation	
CE; cULus; GL	
DIN EN 50178, DIN EN 61000-4-2	
EN 55011, EN 61000-6	
300 V	
6 kV	
2	
III	
≥ 5.5 mm (1 mm Input/output)	
2.5 kV	
Screw connection	Tension clamp connection
2.5 / 0.5 / 2.5	2.5 / 0.5 / 2.5
112.4 / 45 /	112.4 / 45 /

Typical functions

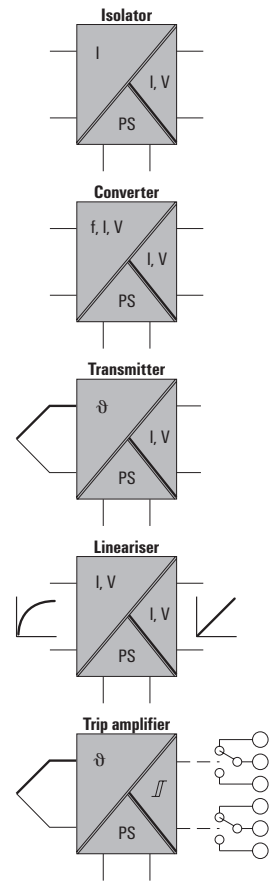

Ordering data

Type	Qty.	Order No.
Screw connection		
WAS6 TTA	1	8939670000
Tension clamp conn.		
WAZ6 TTA	1	8939680000

CBX200 USB configuration adapter - 8978580000

WAVE TTA EX

- Input and outputs can be configured on PC with the TTA-SET software, download at www.weidmueller.com
- Universal input signals
- Loop-powered or passive input
- Pluggable connection terminals
- ATEX 3 G Ex nA IIC T4
- UL Class I, Div.2

WAS6 TTA EX / WAZ6 TTA EX

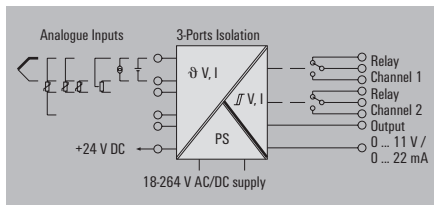

Technical data

Input	
Sensor	
Potentiometer	
Resistance	
Input frequency	
Input voltage	
Input current	
Sensor supply	
Output analogue	
Output voltage	
Output current	
Load impedance, voltage/current	
Signal output	
Transmit function	
Output digital	
Type	
Switching voltage AC, max. / DC, max.	
Continuous current	
General data	
Configuration	
Supply voltage	
Power consumption	
Accuracy	
Temperature coefficient	
Ambient temperature / Storage temperature	
Step response time	
Humidity	
Approvals	
Insulation coordination	
Standards	
EMC standards	
Rated voltage	
Impulse withstand voltage	
Pollution degree	
Overvoltage category	
Clearance & creepage distances	
Insulation voltage	
Dimensions	
Clamping range (nominal / min. / max.)	mm ²
Depth x width x height	mm
Note	

Thermocouples: B, E, J, K, L, N, R, S, T (IEC 60584), PT100, PT1000, (EN 60571) Ni100, Ni1000, (JIS1604), Cu10, Cu25, Cu50, Cu100 (DIN 43760) 2-/3-/4-wire	
100 Ω ...100 k Ω	
10 Ω ...5 k Ω	
2 Hz...100 kHz	
-200...500 mV (min. 4 mV span), -20...50 V DC (min. 0.5 V span)	
-20...50 mA (min. span 0.4 mA)	
24 V DC / 22 mA	
Adjustable between -10...+10 V (min. span of 2.5 V)	
Adjustable between 0...20 mA (min. span of 5 mA)	
> 10 k Ω @ 0...10 V / > 20 k Ω @ -10...+10 V / < 700 Ω	
direct or inverted	
Linear, $x^{1/2}$, $x^{3/2}$, $x^{5/2}$ or user-defined curve (101 points)	
2 x 1 C0 contact (hard gold-plated)	
250 V / 30 V	
2 A AC/DC	
TTA Set Software	
24...240 V AC/DC; 24...36 V AC / 24...50 V DC (ATEX Zone 2)	
< 3,5 W	
< 0.1 % span (DC, RTD); 0.2 % span (or 1 °C) + CJ failure	
< 0.1 % / K (DC, RTD); < 0.1 % FSR / K + CJ error 0.07 °C/K (thermocouples)	
-40 °C...+70 °C / -40 °C...+85 °C	
50 ms...1 sec (RTD, mV inputs), 110 ms...1 sec (V, mA inputs)	
5...95 %, no condensation	
CE; cULus; cULusEX; KEMAATEX	
DIN EN 50178, DIN EN 60079, DIN EN 61000-4-2	
EN 55011, EN 61000-6	
300 V	
6 kV	
2	
III	
\geq 5.5 mm (1 mm _{Input/output})	
2.5 kV	
Screw connection	Tension-clamp connection
2.5 / 0.5 / 2.5	2.5 / 0.5 / 2.5
112.4 / 45 /	112.4 / 45 /

Typical functions

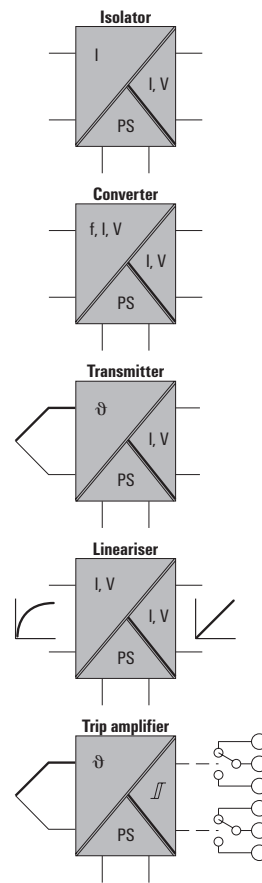

Ordering data

Type	Qty.	Order No.
Screw connection		
WAS6 TTA EX	1	8964310000
Tension clamp conn.		
WAZ6 TTA EX	1	8964320000

CBX200 USB configuration adapter - 8978580000

ITXPlus

Universal, loop powered signal isolating converter

The ITXPlus is a compact signal isolating converter that is loop-powered, programmable and electrically isolated. On the input side, the user can connect DC-current/voltage signals, 2-, 3-, or 4-wire PT100s, and thermocouples. The ITXPlus measures, filters and isolates the input signals. It converts them into a proportional signal from 4 to 20 mA. The ITXPlus provides a 4 to 20 mA current loop output. For linear temperature measurements, you can connect all standard types of thermocouples and resistance temperature detectors (RTDs). The ITXPlus can also process signals from any non-linear device, such as a NTC or PTC sensor, or log. potentiometer. User-definable curves can be programmed into a table containing up to 101 co-ordinates for thermocouple and RTD ranges and 25 for other variables. Furthermore, the ITXPlus can be connected to resistors, potentiometers and sensors which operate in the mV/mA

range. Functionality also includes square root extraction, and x to the power 3/2 and 5/2 transfer functions. Other characteristic curves which have not been pre-programmed can be entered directly using a PC. In this way you can reproduce any sensor's characteristic curve. The T-Set software can be used for configuration or for showing measurement trends. The CBX100 interface connects the ITXPlus with the PC. It implements complete electrical isolation between the serial port and the signal converter.

Technical data

Inputs		
Type		
Thermocouple inputs	Type	Standard
	B	
	C	
	E	IEC584
	J	
	K	
	L	DIN 43710
	N	
	R	IEC584
	S	
	T	
	W3, W5	ASTM E98890
	User-defined Input	
Cold-junction compensation		
Wire-break recognition		
mA		
Volt		
mV		
2, 3, 4-wire RTD	Type	Standard
	PT 100	DIN 43710
	PT 100	JIS
	PT 200	DIN 43710
	PT 200	JIS
	NI 120	DIN 43710
	CU 100	DIN 43710
	Cable resistance	
	Sensor current	
	Influence of cable resistance sensor (3/4 wire)	
Resistance		
Accuracy		
Type	Range	
E,J,K,L,N,T,U	< 500 °C	
	> 500 °C	
B, C, R, S, W3, W5		
mV, V, mA		All
PT100/RTD		
Resistance		

Thermocouple, PT100/RTD, mA, volt, mV, resistance		
Lower limit	Upper limit	Min. range
400 °C	1828 °C	200 °C
0 °C	2000 °C	
-100 °C	1000 °C	50 °C
-100 °C	1200 °C	
-180 °C	1372 °C	
-100 °C	900 °C	100 °C
-180 °C	1300 °C	
-50 °C	1760 °C	200 °C
-50 °C	1760 °C	
-200 °C	400 °C	50 °C
0 °C	2300 °C	200 °C
2-101 values		
± 1.0 °C		
yes		
-10 mA to + 20 mA to 40 Ω input resistance (min. range 1 mA)		
-5 V to + 10 V to 2 M Ω input resistance (min. range 0.5 V)		
-100 mV to + 200 mV to 2 M Ω input resistance (min range 4 mV)		
Lower limit	Upper limit	Min. range
-200 °C	850 °C	50 °C
-200 °C	630 °C	
-200 °C	850 °C	
-200 °C	630 °C	100 °C
-80 °C	320 °C	
-100 °C	260 °C	
5 Ω max.		
0,1 mA		
< 0.002 Ω per Ω wire resistance		
0 to 10 k Ω (min. range 10 Ω)		
Temperature coefficient		Accuracy
± 0.02 °C per °C ambient temperature		≤ ± 1.0 °C
± 0.01 % of end value per °C ambient temperature		
± 0.02 °C per °C ambient temperature		≤ ± 2.0 °C
		≤ ± 0.1 % of end value
		≤ ± 0.5 °C
		≤ ± 0.1 % of end value

ITXPlus

Universal signal isolator/converter with 2-wire technology

- Current, voltage and temperature inputs (RTD, TC)
- Supply via output loop (Output loop-powered)
- PC-programmable with T-SET, download at www.weidmueller.com
- Pluggable connection terminals

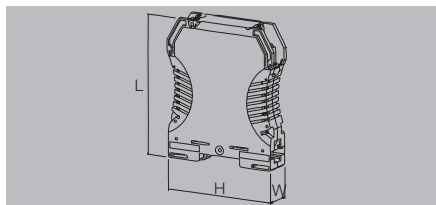

ITXPlus

Programmable with T-SET

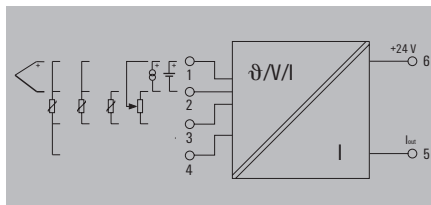

Technical data

Input	
Type	RTD, TC, DC (mA, V), Voltages (≤ 100 mV), Current input [mA], Thermocouple
Type, thermocouple	B / C / E / J / K / L / N / R / S / T / W3 / W5 -200...+2300 °C depending on thermocouple
Type, RTD	PT100, PT1000, (EN 60571) Ni100, Ni1000, (JIS1604), Cu10, Cu25, Cu50, Cu100 (DIN 43760) 2-/3-/4-Leiter
Input current	-10...+20 mA (min. span 1 mA)
Input voltage	-5...+10 V / -100...+200 mV (min. span 0.5 V / 4 mV)
Input resistance, voltage/current	2 M Ω / 40 Ω
Output	
Type	Current output
Output current	4...20 mA
Load impedance current	typ. 700 Ω @ 24 V DC
General data	
Configuration	T Set Software
Supply voltage	10...40 V DC, loop powered
Humidity	10...90 % (no condensation)
Temperature coefficient	typ. 0.02 % / °C
Ambient temperature / Storage temperature	-10 °C...+70 °C / -20 °C...+70 °C
Long-term drift	0.1 % / 10.000 h
Step response time	Typ. 200 ms (10...90%)
Insulation coordination	
Impulse withstand voltage	4 kV (1.2/50 μ s)
Rated voltage	300 V _{eff}
Insulation voltage	2 kV input / output
EMC standards	DIN EN 61326
Approvals	CE; cULus; cULusEX

Dimensions	
Clamping range (nominal / min. / max.)	mm ²
Length x width x height	mm
Note	

Ordering data

Universal input

Note

Accessories

Note

Technical data	
Type	RTD, TC, DC (mA, V), Voltages (≤ 100 mV), Current input [mA], Thermocouple
Type, thermocouple	B / C / E / J / K / L / N / R / S / T / W3 / W5 -200...+2300 °C depending on thermocouple
Type, RTD	PT100, PT1000, (EN 60571) Ni100, Ni1000, (JIS1604), Cu10, Cu25, Cu50, Cu100 (DIN 43760) 2-/3-/4-Leiter
Input current	-10...+20 mA (min. span 1 mA)
Input voltage	-5...+10 V / -100...+200 mV (min. span 0.5 V / 4 mV)
Input resistance, voltage/current	2 M Ω / 40 Ω
Output	
Type	Current output
Output current	4...20 mA
Load impedance current	typ. 700 Ω @ 24 V DC
General data	
Configuration	T Set Software
Supply voltage	10...40 V DC, loop powered
Humidity	10...90 % (no condensation)
Temperature coefficient	typ. 0.02 % / °C
Ambient temperature / Storage temperature	-10 °C...+70 °C / -20 °C...+70 °C
Long-term drift	0.1 % / 10.000 h
Step response time	Typ. 200 ms (10...90%)
Insulation coordination	
Impulse withstand voltage	4 kV (1.2/50 μ s)
Rated voltage	300 V _{eff}
Insulation voltage	2 kV input / output
EMC standards	DIN EN 61326
Approvals	CE; cULus; cULusEX

Screw connection	
1.5 / 0.5 / 2.5	
92.4 / 12.5 / 112.4	
Note	

Type	Qty.	Order No.
ITXPlus	1	7940016563

Note

Note

Connections

Terminal	Signal	
5	Loop -ve	Supply voltage
6	Loop +ve	
1	Signal + Power supply Sensor	Thermocouple
2	Signal + Power supply Storage (only for programming)	
1	A-Sense	4-wire PT100/RTD (or resistance)
3	A	
2	B	
4	B-Sense	
1	A-Sense	3-wire PT100/RTD (or resistance)
3	A	
2	B	2-wire PT100/RTD (or resistance)
3	A	
1	Signal +	Voltage (mV or V)
2	Signal -	
1	Signal +	Current (mA)
2	Signal -	
3	A	Potentiometer
1	Wiper	
2	B	

WAVESERIES - DC/DC 3-way isolator

Configurable

- Universally adjustable via DIP switch
- WAVETOOL software helps with configuration, download at www.weidmuller.com
- Power supply 20...230 V AC/DC
- Minimal power loss
- Adjustable transmission frequency

PRO DC/DC

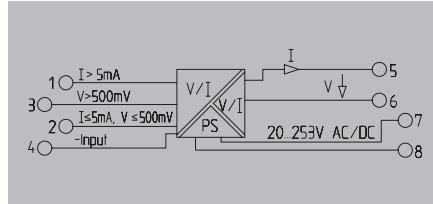
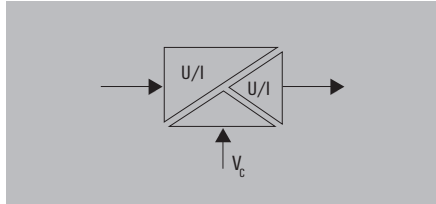

Technical data

Input	
Input voltage / Input current	$\pm 20 \text{ mV} \dots \pm 200 \text{ V} / \pm 0.1 \text{ mA} \dots \pm 100 \text{ mA}$
Input resistance, voltage/current	approx. $1 \text{ M}\Omega$ / $< 5 \text{ mA}$: approx. 100Ω ; $> 5 \text{ mA}$: approx. 5Ω
Output	
Output voltage / Output current	$0 \dots \pm 10 \text{ V} / 0 \dots \pm 20 \text{ mA}$
Load impedance, voltage/current	$\geq 1 \text{ k}\Omega$ / $\leq 600 \Omega$
Cut-off frequency (-3 dB)	$> 10 \text{ kHz} / < 10 \text{ Hz}$
Offset current / Offset voltage	$20 \mu\text{A} / 10 \text{ mV}$
Adjustment range, zero point	$\pm 25 \%$ of the measuring span of selected output range
Adjustment range, amplification	$0.33 \dots 3.30 \times$ end value of selected output range
Displacement	$-100\%, -50\%, 0\%, 50\%, 100\%$ of measuring span
General data	
Configuration	DIP switch, Potentiometer
Supply voltage	$22 \dots 230 \text{ V AC/DC} + 10 \%$
Power consumption	ca. 1 W
Accuracy	$< 0.1 \%$ of end value, + Offset 0.1%
Temperature coefficient	$\leq 60 \text{ ppm/K}$ of final value
Ambient temperature	$-10 \text{ }^\circ\text{C} \dots +70 \text{ }^\circ\text{C}$
Approvals	CE; cULus; cULusEX; EXNACONF; GL
Insulation coordination	
Standards	DIN EN 61010-1, DIN EN 60079, DIN EN 61000-4-2
EMC standards	DIN EN 61326, EN 61000-2-6, EN 61709 (SN 29500) MTBF
Rated voltage	600 V
Impulse withstand voltage	$5 \text{ kV}, 1.2/50 \mu\text{s}$ (IEC 255-4)
Insulation voltage input or output/supply	$4 \text{ kV}_{\text{eff}}$
Overvoltage category	III
Pollution degree	2

Dimensions		
Clamping range (nominal / min. / max.)	mm^2	
Depth x width x height	mm	
Note		
Screw connection	Tension-clamp connection	
$2.5 / 0.5 / 2.5$	$1.5 / 0.5 / 2.5$	
$112.4 / 12.5$	$112.4 / 12.5$	
Type	Qty.	Order No.
WAS4 PRO DC/DC	1	8560740000
WAZ4 PRO DC/DC	1	8560750000
Note		
Accessories		
Note		Markers - refer to Accessories.

Dimensions	
Clamping range (nominal / min. / max.)	mm^2
Depth x width x height	mm
Note	

Ordering data

	Screw connection
	Tension-clamp connection

Note	
-------------	--

Accessories

Note	
-------------	--

Switch position/setting options

Input	Switch							
	S1				S2			
Input range	1	2	3	4	1	2	3	4
0 ... $\pm 60 \text{ mV}$	<input type="checkbox"/>	<input type="checkbox"/>	<input type="checkbox"/>	<input type="checkbox"/>	<input type="checkbox"/>	<input type="checkbox"/>	<input type="checkbox"/>	<input checked="" type="checkbox"/>
0 ... $\pm 100 \text{ mV}$	<input checked="" type="checkbox"/>	<input type="checkbox"/>	<input type="checkbox"/>	<input type="checkbox"/>	<input type="checkbox"/>	<input type="checkbox"/>	<input type="checkbox"/>	<input checked="" type="checkbox"/>
0 ... $\pm 150 \text{ mV}$	<input type="checkbox"/>	<input checked="" type="checkbox"/>	<input type="checkbox"/>	<input type="checkbox"/>	<input type="checkbox"/>	<input type="checkbox"/>	<input type="checkbox"/>	<input checked="" type="checkbox"/>
0 ... $\pm 300 \text{ mV}$	<input checked="" type="checkbox"/>	<input checked="" type="checkbox"/>	<input type="checkbox"/>	<input type="checkbox"/>	<input type="checkbox"/>	<input type="checkbox"/>	<input type="checkbox"/>	<input checked="" type="checkbox"/>
0 ... $\pm 500 \text{ mV}$	<input type="checkbox"/>	<input type="checkbox"/>	<input checked="" type="checkbox"/>	<input type="checkbox"/>	<input type="checkbox"/>	<input type="checkbox"/>	<input type="checkbox"/>	<input checked="" type="checkbox"/>
0 ... $\pm 1 \text{ V}$	<input checked="" type="checkbox"/>	<input type="checkbox"/>	<input checked="" type="checkbox"/>	<input type="checkbox"/>	<input type="checkbox"/>	<input checked="" type="checkbox"/>	<input type="checkbox"/>	<input checked="" type="checkbox"/>
0 ... $\pm 5 \text{ V}$	<input type="checkbox"/>	<input checked="" type="checkbox"/>	<input checked="" type="checkbox"/>	<input type="checkbox"/>	<input type="checkbox"/>	<input type="checkbox"/>	<input type="checkbox"/>	<input checked="" type="checkbox"/>
0 ... $\pm 10 \text{ V}$	<input checked="" type="checkbox"/>	<input checked="" type="checkbox"/>	<input type="checkbox"/>	<input type="checkbox"/>	<input type="checkbox"/>	<input type="checkbox"/>	<input type="checkbox"/>	<input checked="" type="checkbox"/>
0 ... $\pm 100 \text{ V}$	<input type="checkbox"/>	<input type="checkbox"/>	<input type="checkbox"/>	<input checked="" type="checkbox"/>	<input type="checkbox"/>	<input type="checkbox"/>	<input checked="" type="checkbox"/>	<input checked="" type="checkbox"/>
0 ... $\sim 0.3 \text{ mA}$	<input checked="" type="checkbox"/>	<input type="checkbox"/>	<input type="checkbox"/>	<input checked="" type="checkbox"/>	<input checked="" type="checkbox"/>	<input type="checkbox"/>	<input type="checkbox"/>	<input checked="" type="checkbox"/>
0 ... $\pm 1 \text{ mA}$	<input type="checkbox"/>	<input checked="" type="checkbox"/>	<input checked="" type="checkbox"/>	<input type="checkbox"/>	<input checked="" type="checkbox"/>	<input type="checkbox"/>	<input type="checkbox"/>	<input checked="" type="checkbox"/>
0 ... $\pm 5 \text{ mA}$	<input checked="" type="checkbox"/>	<input checked="" type="checkbox"/>	<input type="checkbox"/>	<input type="checkbox"/>	<input type="checkbox"/>	<input type="checkbox"/>	<input type="checkbox"/>	<input checked="" type="checkbox"/>
0 ... $\pm 10 \text{ mA}$	<input type="checkbox"/>	<input type="checkbox"/>	<input checked="" type="checkbox"/>	<input checked="" type="checkbox"/>	<input type="checkbox"/>	<input type="checkbox"/>	<input type="checkbox"/>	<input checked="" type="checkbox"/>
0 ... $\pm 20 \text{ mA}$	<input checked="" type="checkbox"/>	<input type="checkbox"/>	<input checked="" type="checkbox"/>	<input checked="" type="checkbox"/>	<input type="checkbox"/>	<input type="checkbox"/>	<input type="checkbox"/>	<input checked="" type="checkbox"/>
0 ... $\pm 50 \text{ mA}$	<input type="checkbox"/>	<input checked="" type="checkbox"/>	<input checked="" type="checkbox"/>	<input type="checkbox"/>	<input checked="" type="checkbox"/>	<input type="checkbox"/>	<input type="checkbox"/>	<input checked="" type="checkbox"/>
4 ... $\pm 20 \text{ mA}^*$	<input checked="" type="checkbox"/>	<input checked="" type="checkbox"/>	<input checked="" type="checkbox"/>	<input checked="" type="checkbox"/>	<input checked="" type="checkbox"/>	<input type="checkbox"/>	<input type="checkbox"/>	<input checked="" type="checkbox"/>

	Switch S2	4
calibrated ranges		<input checked="" type="checkbox"/>
Span-pot. activated: input x 0.33 ... x 3.30		
non calibrated range		<input type="checkbox"/>

Output	Switch					
	S1			S3		
Output range	5	6	7	1	2	
0 ... $\pm 10 \text{ V}$	<input type="checkbox"/>	<input type="checkbox"/>	<input type="checkbox"/>	<input checked="" type="checkbox"/>	<input checked="" type="checkbox"/>	
2 ... 10 V	<input checked="" type="checkbox"/>	<input type="checkbox"/>	<input type="checkbox"/>	<input checked="" type="checkbox"/>	<input checked="" type="checkbox"/>	
0 ... $\pm 5 \text{ V}$	<input type="checkbox"/>	<input checked="" type="checkbox"/>	<input type="checkbox"/>	<input checked="" type="checkbox"/>	<input checked="" type="checkbox"/>	
1 ... 5 V	<input checked="" type="checkbox"/>	<input checked="" type="checkbox"/>	<input type="checkbox"/>	<input checked="" type="checkbox"/>	<input checked="" type="checkbox"/>	
0 ... $\pm 20 \text{ mA}$	<input type="checkbox"/>	<input type="checkbox"/>	<input checked="" type="checkbox"/>	<input type="checkbox"/>	<input type="checkbox"/>	
4 ... 20 mA	<input checked="" type="checkbox"/>	<input type="checkbox"/>	<input checked="" type="checkbox"/>	<input type="checkbox"/>	<input type="checkbox"/>	

Offset (in % of output voltage)	S1			S2
	8	9	10	5
0 %	<input type="checkbox"/>	<input type="checkbox"/>	<input type="checkbox"/>	<input checked="" type="checkbox"/>
-100 %	<input checked="" type="checkbox"/>	<input type="checkbox"/>	<input type="checkbox"/>	<input checked="" type="checkbox"/>
-50 %	<input type="checkbox"/>	<input checked="" type="checkbox"/>	<input type="checkbox"/>	<input checked="" type="checkbox"/>
+50 %	<input checked="" type="checkbox"/>	<input checked="" type="checkbox"/>	<input type="checkbox"/>	<input checked="" type="checkbox"/>
+100 %	<input type="checkbox"/>	<input type="checkbox"/>	<input checked="" type="checkbox"/>	<input checked="" type="checkbox"/>

	Switch S3	3
Bandwidth 10 kHz		<input type="checkbox"/>
Bandwidth 10 kHz		<input checked="" type="checkbox"/>

Set range can be documented on side of housing.
 = on
 = off

Configurable

Configurable signal isolating converter

- Provides external sensor supply
- Supply with 12...60 V DC
- Current or voltage input can be configured with DIP switch
- Input or output scaling
- Direct or negated output signal
- Low input resistance, ideal for a long sensor wire

WAVEPak

3-way isolator

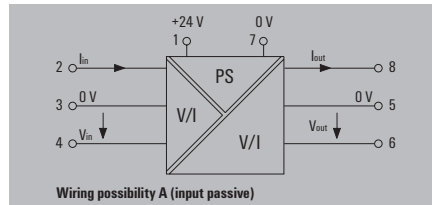
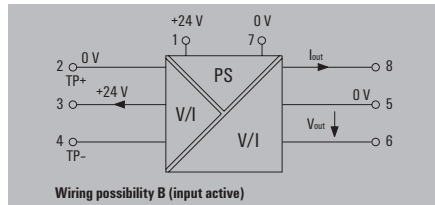

Technical data

Input	
Type	
Input signal	
Sensor supply	
Input resistance, voltage/current	
Resolution	
Output	
Type	
Output current / Output voltage	
Load impedance current	
Load impedance voltage	
General data	
Configuration	
Supply voltage	
Power consumption	
Linearity	
Humidity	
Ambient temperature / Storage temperature	
Temperature coefficient	
Long-term drift	
Step response time	
Approvals	
Insulation coordination	
Impulse withstand voltage	
EMC standards	
Insulation voltage	
Rated voltage	
Overvoltage category	
Pollution degree	

Input	
Current or voltage output configurable with jumper	
0...22 mA or 0...10 V	
20 mA @ 24 V DC output	
> 1 MΩ / 100 Ω	
3.5 μA / 1.76 mV per bit	
Output	
Current or voltage output, configured with jumper	
0...22 mA / 0...10 V	
≤ 1kΩ	
≤ 500 Ω	
General data	
DIP switch	
12...60 V DC	
2.5 W @ 24 V DC	
< ± 0.1 % (typically ± 0.05 %)	
10...90 % (no condensation)	
0 °C...+60 °C / -25 °C...+70 °C	
≤ 0.05 % / °C	
0.1 % / 10.000 h	
< 220 ms (10...90 %)	
CE; cULus; cULusEX	
Insulation coordination	
4 kV (1.2/50 μs)	
DIN EN 61326	
2 kV input / output / power supply	
300 V _{eff}	
III	
2	

Dimensions	
Clamping range (nominal / min. / max.)	mm ²
Depth x width x height	mm
Note	

Screw connection	
1.5 / 0.5 / 2.5	
/ 12.5 / 112.4	
Note	

Ordering data

Universal converter

Type	Qty.	Order No.
WAVEPak DC/DC	1	7940024139

Note

Accessories

Note

Note

Markers - refer to Accessories.

Connections

Terminal	Signal	
1	Signal +	Supply voltage
7	Signal -	
4	Signal +	Voltage input
3	Signal -	
2	Signal +	Current input
3	Signal -	
3	Signal +	Loop Powered Input
2	Signal -	
6	Signal +	Voltage output
5	Signal -	
8	Signal +	Current output
5	Signal -	

20 kHz limiting frequency

- Signal conversion
- Galvanic isolation between input/output signals and power supply
- Power supply can be cross-connected using plug-in jumpers

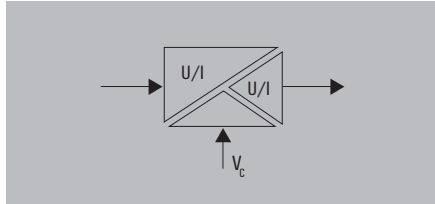

0 (4)...20 mA/0 (4)...20 mA

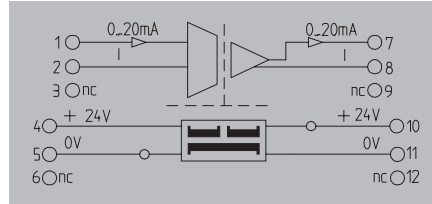

0...20 mA / 0...10 V

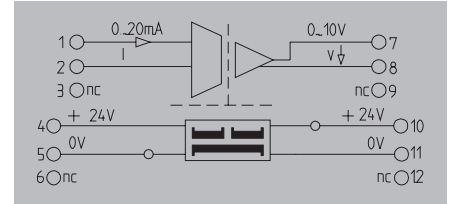

D

Technical data

Input	
Input voltage / Input current	/ 0...20 mA, 4...20 mA
Input resistance, voltage/current	/ 50 Ω
Output	
Output voltage / Output current	/ 0...20 mA, 4...20 mA
Load impedance, voltage/current	/ ≤ 500 Ω
Cut-off frequency (-3 dB)	≥ 15 kHz (typ. 20 kHz)
General data	
Configuration	none
Supply voltage	24 V DC ± 25 %
Power consumption	< 1.5 W @ I _{OUT} = 20 mA
Accuracy	< 0.2 % of end value
Temperature coefficient	≤ 250 ppm/K of final value
Step response time	≤ 40 μs (typ. 30 μs)
Ambient temperature	0 °C...+55 °C
Approvals	CE, CSA, cULus
Insulation coordination	
Standards	DIN EN 50178, DIN EN 61000-4-2
EMC standards	EN 55011, EN 61000-6
Rated voltage	300 V
Impulse withstand voltage	4 kV
Insulation voltage	1.2 kV _{eff} / 5 s
Overvoltage category	III
Pollution degree	2
Clearance & creepage distances	≥ 3 mm

Input	
Input voltage / Input current	/ 0...20 mA
Input resistance, voltage/current	/ 50 Ω
Output	
Output voltage / Output current	/ 0...10 V /
Load impedance, voltage/current	≥ 2 kΩ /
Cut-off frequency (-3 dB)	≥ 15 kHz (typ. 20 kHz)
General data	
Configuration	none
Supply voltage	24 V DC ± 25 %
Power consumption	< 1.3 W @ I _{OUT} = 5 mA
Accuracy	< 0.2 % of end value
Temperature coefficient	≤ 250 ppm/K of final value
Step response time	≤ 40 μs (typ. 30 μs)
Ambient temperature	0 °C...+55 °C
Approvals	CE, CSA, cULus, GOSTME25
Insulation coordination	
Standards	DIN EN 50178, DIN EN 61000-4-2
EMC standards	EN 55011, EN 61000-6
Rated voltage	300 V
Impulse withstand voltage	4 kV
Insulation voltage	1.2 kV _{eff} / 5 s
Overvoltage category	III
Pollution degree	2
Clearance & creepage distances	≥ 3 mm

Dimensions	
Clamping range (nominal / min. / max.)	mm ²
Depth x width x height	mm
Note	
Ordering data	
Note	
Accessories	
Note	

Screw connection		Tension-clamp connection	
2.5 / 0.5 / 2.5	1.5 / 0.5 / 2.5	112.4 / 17.5	112.4 / 17.5
Note			

Screw connection		
2.5 / 0.5 / 2.5	112.4 / 17.5	
Note		

Type	Qty.	Order No.
WAS5 CCC HF 0-20/0-20MA	1	8447160000
WAZ5 CCC HF 0-20/0-20MA	1	8447170000

Type	Qty.	Order No.
WAS5 CVC HF 0-20/0-10V	1	8447220000

Cross-connector for power supplies and markers - refer to Accessories

Cross-connector for power supplies and markers - refer to Accessories

20 kHz limiting frequency

- Signal conversion
- Galvanic isolation between input/output signals and power supply
- Power supply can be cross-connected using plug-in jumpers

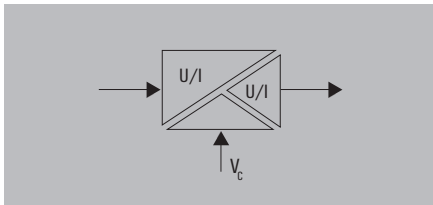

4...20 mA / 0...20 mA

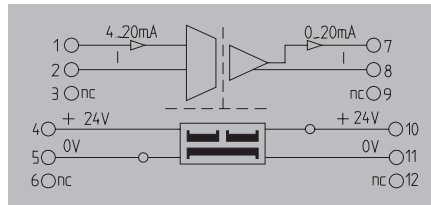

4...20 mA / 0...10 V

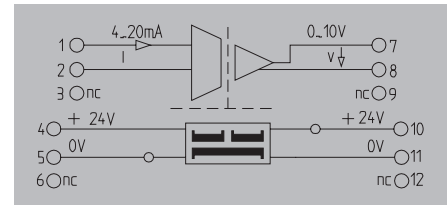

Technical data

Input	
Input voltage / Input current	/ 4...20 mA
Input resistance, voltage/current	/ 50 Ω
Output	
Output voltage / Output current	/ 0...20 mA
Load impedance, voltage/current	/ ≤ 500 Ω
Cut-off frequency (-3 dB)	≥ 15 kHz (typ. 20 kHz)
General data	
Configuration	none
Supply voltage	24 V DC ± 25 %
Power consumption	< 1.5 W @ I _{OUT} = 20 mA
Accuracy	< 0.2 % of end value
Temperature coefficient	≤ 250 ppm/K of final value
Step response time	≤ 40 μs (typ. 30 μs)
Ambient temperature	0 °C...+55 °C
Approvals	CE, CSA, cULus, GOSTME25
Insulation coordination	
Standards	DIN EN 50178, DIN EN 61000-4-2
EMC standards	EN 55011, EN 61000-6
Rated voltage	300 V
Impulse withstand voltage	4 kV
Insulation voltage	1.2 kV _{eff} / 5 s
Overvoltage category	III
Pollution degree	2
Clearance & creepage distances	≥ 3 mm

		/ 4...20 mA
		/ 50 Ω
		/ 0...20 mA
		/ ≤ 500 Ω
		≥ 15 kHz (typ. 20 kHz)
		none
		24 V DC ± 25 %
		< 1.5 W @ I _{OUT} = 20 mA
		< 0.2 % of end value
		≤ 250 ppm/K of final value
		≤ 40 μs (typ. 30 μs)
		0 °C...+55 °C
		CE, CSA, cULus, GOSTME25
		DIN EN 50178, DIN EN 61000-4-2
		EN 55011, EN 61000-6
		300 V
		4 kV
		1.2 kV _{eff} / 5 s
		III
		2
		≥ 3 mm

		/ 4...20 mA
		/ 50 Ω
		0...10 V /
		≥ 2 kΩ / ≤ 600 Ω
		≥ 15 kHz (typ. 20 kHz)
		none
		24 V DC ± 25 %
		< 1.3 W @ I _{OUT} = 5 mA
		< 0.2 % of end value
		≤ 250 ppm/K of final value
		≤ 40 μs (typ. 30 μs)
		0 °C...+55 °C
		CE, CSA, cULus, cULusEX, GOSTME25
		DIN EN 50178, DIN EN 61000-4-2
		EN 55011, EN 61000-6
		300 V
		4 kV
		1.2 kV _{eff} / 5 s
		III
		2
		≥ 3 mm

Dimensions	
Clamping range (nominal / min. / max.)	mm ²
Depth x width x height	mm
Note	

Screw connection	
	2.5 / 0.5 / 2.5
	112.4 / 17.5
Note	

Screw connection	
	2.5 / 0.5 / 2.5
	112.4 / 17.5
Note	

Ordering data

	Screw connection
--	------------------

Type	Qty.	Order No.
WAS5 CCC HF 4-20/0-20MA	1	8447250000

Type	Qty.	Order No.
WAS5 CVC HF 4-20/0-10V	1	8447280000

Note	
-------------	--

Note	
-------------	--

Note	
-------------	--

Accessories

Note	
-------------	--

	Cross-connector for power supplies and markers - refer to Accessories
--	---

	Cross-connector for power supplies and markers - refer to Accessories
--	---

20 kHz limiting frequency

- Signal conversion
- Galvanic isolation between input/output signals and power supply
- Power supply can be cross-connected using plug-in jumpers

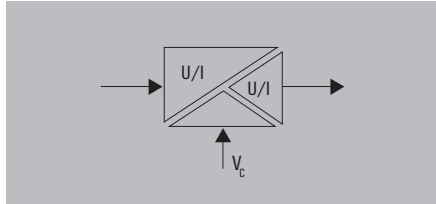

0...10 V / 0...20 mA

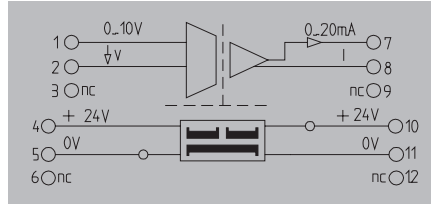

0...10 V / 4...20 mA

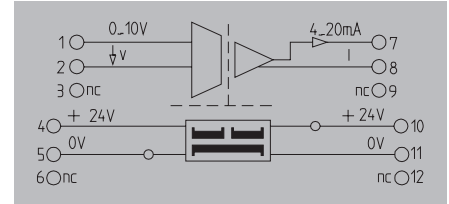

UL Class I, Div. 2

D

Technical data

Input	
Input voltage / Input current	0...10 V /
Input resistance, voltage/current	500 kΩ /
Output	
Output voltage / Output current	/ 0...20 mA
Load impedance, voltage/current	/ ≤ 500 Ω
Cut-off frequency (-3 dB)	≥ 15 kHz (typ. 20 kHz)
General data	
Configuration	none
Supply voltage	24 V DC ± 25 %
Power consumption	< 1.5 W @ I _{OUT} = 20 mA
Accuracy	± 0.2 % of final value
Temperature coefficient	≤ 250 ppm/K of final value
Step response time	≤ 40 μs (typ. 30 μs)
Ambient temperature	0 °C...+55 °C
Approvals	CE, CSA, cULus, GOSTME25
Insulation coordination	
Standards	DIN EN 50178, DIN EN 61000-4-2
EMC standards	EN 55011, EN 61000-6
Rated voltage	300 V
Impulse withstand voltage	4 kV
Insulation voltage	1.2 kV _{eff} / 5 s
Overvoltage category	III
Pollution degree	2
Clearance & creepage distances	≥ 3 mm

Input	
Input voltage / Input current	0...10 V /
Input resistance, voltage/current	500 kΩ /
Output	
Output voltage / Output current	/ 4...20 mA
Load impedance, voltage/current	/ ≤ 500 Ω
Cut-off frequency (-3 dB)	≥ 15 kHz (typ. 20 kHz)
General data	
Configuration	none
Supply voltage	24 V DC ± 25 %
Power consumption	< 1.5 W @ I _{OUT} = 20 mA
Accuracy	± 0.2 % of final value
Temperature coefficient	≤ 250 ppm/K of final value
Step response time	≤ 40 μs (typ. 30 μs)
Ambient temperature	0 °C...+55 °C
Approvals	CE, CSA, cULus, GOSTME25
Insulation coordination	
Standards	DIN EN 50178, DIN EN 61000-4-2
EMC standards	EN 55011, EN 61000-6
Rated voltage	300 V
Impulse withstand voltage	4 kV
Insulation voltage	1.2 kV _{eff} / 5 s
Overvoltage category	III
Pollution degree	2
Clearance & creepage distances	≥ 3 mm

Input	
Input voltage / Input current	0...10 V /
Input resistance, voltage/current	500 kΩ /
Output	
Output voltage / Output current	/ 4...20 mA
Load impedance, voltage/current	/ ≤ 500 Ω
Cut-off frequency (-3 dB)	≥ 15 kHz (typ. 20 kHz)
General data	
Configuration	none
Supply voltage	24 V DC ± 25 %
Power consumption	< 1.5 W @ I _{OUT} = 20 mA
Accuracy	± 0.2 % of final value
Temperature coefficient	≤ 250 ppm/K of final value
Step response time	≤ 40 μs (typ. 30 μs)
Ambient temperature	0 °C...+55 °C
Approvals	CE, CSA, cULus, cULusEX, GOSTME25
Insulation coordination	
Standards	DIN EN 50178, DIN EN 61000-4-2
EMC standards	EN 55011, EN 61000-6
Rated voltage	300 V
Impulse withstand voltage	4 kV
Insulation voltage	1.2 kV _{eff} / 5 s
Overvoltage category	III
Pollution degree	2
Clearance & creepage distances	≥ 3 mm

Dimensions	
Clamping range (nominal / min. / max.)	mm ²
Depth x width x height	mm
Note	

Screw connection	
2.5 / 0.5 / 2.5	
112.4 / 17.5	
Note	

Screw connection	
2.5 / 0.5 / 2.5	
112.4 / 17.5	
Note	

Ordering data

Screw connection

Type	Qty.	Order No.
WAS5 VCC HF 0-10/0-20MA	1	8447310000

Type	Qty.	Order No.
WAS5 VCC HF 0-10/4-20MA	1	8447340000

Note

Note

Note

Accessories

Note

Cross-connector for power supplies and markers - refer to Accessories

Cross-connector for power supplies and markers - refer to Accessories

20 kHz limiting frequency

- Signal conversion
- Galvanic isolation between input/output signals and power supply
- Power supply can be cross-connected using plug-in jumpers

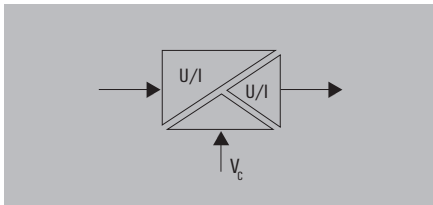

0...10 V / 0...10 V

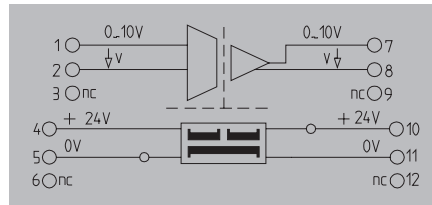

-10 V...+10 V / -10 V...+10 V

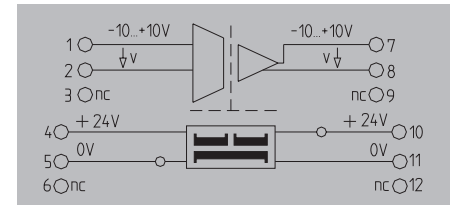

Technical data

Input	
Input voltage / Input current	0...10 V /
Input resistance, voltage/current	500 kΩ /
Output	
Output voltage / Output current	0...10 V /
Load impedance, voltage/current	≥ 2 kΩ /
Cut-off frequency (-3 dB)	≥ 15 kHz (typ. 20 kHz)
General data	
Configuration	none
Supply voltage	24 V DC ± 25 %
Power consumption	< 1.3 W @ I _{OUT} = 5 mA
Accuracy	± 0.2 % of final value
Temperature coefficient	≤ 250 ppm/K of final value
Step response time	≤ 40 μs (typ. 30 μs)
Ambient temperature	0 °C...+55 °C
Approvals	CE, CSA, cULus
Insulation coordination	
Standards	DIN EN 50178, DIN EN 61000-4-2
EMC standards	EN 55011, EN 61000-6
Rated voltage	300 V
Impulse withstand voltage	4 kV
Insulation voltage	1.2 kV _{eff} / 5 s
Overvoltage category	III
Pollution degree	2
Clearance & creepage distances	≥ 3 mm

Input	
Input voltage / Input current	0...10 V /
Input resistance, voltage/current	500 kΩ /
Output	
Output voltage / Output current	0...10 V /
Load impedance, voltage/current	≥ 2 kΩ /
Cut-off frequency (-3 dB)	≥ 15 kHz (typ. 20 kHz)
General data	
Configuration	none
Supply voltage	24 V DC ± 25 %
Power consumption	< 1.3 W @ I _{OUT} = 5 mA
Accuracy	± 0.2 % of final value
Temperature coefficient	≤ 250 ppm/K of final value
Step response time	≤ 40 μs (typ. 30 μs)
Ambient temperature	0 °C...+55 °C
Approvals	CE, CSA, cULus
Insulation coordination	
Standards	DIN EN 50178, DIN EN 61000-4-2
EMC standards	EN 55011, EN 61000-6
Rated voltage	300 V
Impulse withstand voltage	4 kV
Insulation voltage	1.2 kV _{eff} / 5 s
Overvoltage category	III
Pollution degree	2
Clearance & creepage distances	≥ 3 mm

Input	
Input voltage / Input current	-10...+10 V /
Input resistance, voltage/current	500 kΩ /
Output	
Output voltage / Output current	-10...+10 V /
Load impedance, voltage/current	≥ 2 kΩ /
Cut-off frequency (-3 dB)	≥ 15 kHz (typ. 20 kHz)
General data	
Configuration	none
Supply voltage	24 V DC ± 25 %
Power consumption	< 1.3 W @ I _{OUT} = 5 mA
Accuracy	± 0.2 % of measuring range
Temperature coefficient	≤ 250 ppm/K of measuring range
Step response time	≤ 40 μs (typ. 30 μs)
Ambient temperature	0 °C...+55 °C
Approvals	CE, cULus, GOSTME25
Insulation coordination	
Standards	DIN EN 50178, DIN EN 61000-4-2
EMC standards	EN 55011, EN 61000-6
Rated voltage	300 V
Impulse withstand voltage	4 kV
Insulation voltage	1.2 kV _{eff} / 5 s
Overvoltage category	III
Pollution degree	2
Clearance & creepage distances	≥ 3 mm

Dimensions	
Clamping range (nominal / min. / max.)	mm ²
Depth x width x height	mm
Note	

Screw connection		Tension-clamp connection	
2.5 / 0.5 / 2.5	112.4 / 17.5	1.5 / 0.5 / 2.5	112.4 / 17.5
Note		Note	

Screw connection	
2.5 / 0.5 / 2.5	112.4 / 17.5
Note	

Ordering data

Screw connection	
Tension-clamp connection	
Note	

Type	Qty.	Order No.
WAS5 VVC HF 0-10/0-10V	1	8447370000
WAZ5 VVC HF 0-10/0-10V	1	8447380000

Type	Qty.	Order No.
WAS5 VVC HF +10V/+10V	1	8561610000

Note

Accessories

Note

Cross-connector for power supplies and markers - refer to Accessories

Cross-connector for power supplies and markers - refer to Accessories

10 Hz limiting frequency

- Signal conversion
- Galvanic isolation between input/output signals and power supply
- Power supply can be cross-connected using plug-in jumpers

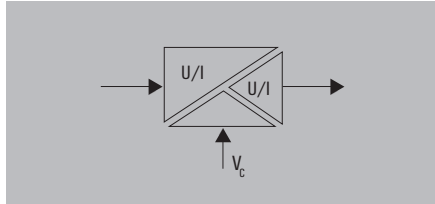

0(4)...20 mA / 0(4)...20 mA

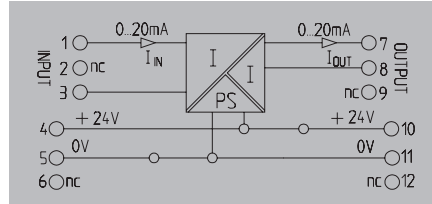

0...20 mA / 4...20 mA

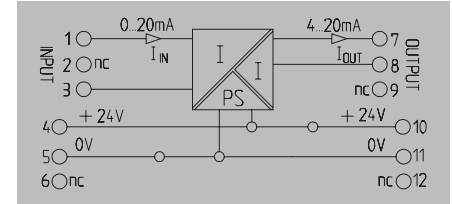

Technical data

Input	
Input voltage / Input current	/ 0...20 mA, 4...20 mA
Output	
Output voltage / Output current	/ 0...20 mA, 4...20 mA
Load impedance, voltage/current	/ ≤ 600 Ω
Cut-off frequency (-3 dB)	10 Hz
General data	
Configuration	none
Supply voltage	24 V DC ± 25 %
Power consumption	< 1.5 W @ I _{OUT} = 20 mA
Accuracy	0.2 %
Temperature coefficient	± 250 ppm/K
Step response time	≤ 45 ms
Ambient temperature	0 °C...+55 °C
Approvals	CE; cULus
Insulation coordination	
Standards	DIN EN 50178, DIN EN 61000-4-2
EMC standards	EN 55011, EN 61000-6
Rated voltage	300 V
Impulse withstand voltage	4 kV
Insulation voltage	2 kV _{eff} / 5 s
Overvoltage category	III
Pollution degree	2
Clearance & creepage distances	≥ 3 mm

Input	
Input voltage / Input current	/ 0...20 mA, 4...20 mA
Output	
Output voltage / Output current	/ 4...20 mA
Load impedance, voltage/current	/ ≤ 600 Ω
Cut-off frequency (-3 dB)	10 Hz
General data	
Configuration	none
Supply voltage	24 V DC ± 25 %
Power consumption	< 1.5 W @ I _{OUT} = 20 mA
Accuracy	0.2 %
Temperature coefficient	± 250 ppm/K
Step response time	≤ 45 ms
Ambient temperature	0 °C...+55 °C
Approvals	CE; cULus; GOSTME25
Insulation coordination	
Standards	DIN EN 50178, DIN EN 61000-4-2
EMC standards	EN 55011, EN 61000-6
Rated voltage	300 V
Impulse withstand voltage	4 kV
Insulation voltage	2 kV _{eff} / 5 s
Overvoltage category	III
Pollution degree	2
Clearance & creepage distances	≥ 3 mm

Input	
Input voltage / Input current	/ 0...20 mA
Output	
Output voltage / Output current	/ 4...20 mA
Load impedance, voltage/current	/ ≤ 600 Ω
Cut-off frequency (-3 dB)	10 Hz
General data	
Configuration	none
Supply voltage	24 V DC ± 25 %
Power consumption	< 1.5 W @ I _{OUT} = 20 mA
Accuracy	0.2 %
Temperature coefficient	± 250 ppm/K
Step response time	≤ 45 ms
Ambient temperature	0 °C...+55 °C
Approvals	CE; cULus; GOSTME25
Insulation coordination	
Standards	DIN EN 50178, DIN EN 61000-4-2
EMC standards	EN 55011, EN 61000-6
Rated voltage	300 V
Impulse withstand voltage	4 kV
Insulation voltage	2 kV _{eff} / 5 s
Overvoltage category	III
Pollution degree	2
Clearance & creepage distances	≥ 3 mm

Dimensions	
Clamping range (nominal / min. / max.)	mm ²
Depth x width x height	mm
Note	

Screw connection		Tension-clamp connection	
2.5 / 0.5 / 2.5	1.5 / 0.5 / 2.5	2.5 / 0.5 / 2.5	1.5 / 0.5 / 2.5
112.4 / 17.5	112.4 / 17.5	112.4 / 17.5	112.4 / 17.5
Note		Note	

Screw connection	
2.5 / 0.5 / 2.5	1.5 / 0.5 / 2.5
112.4 / 17.5	112.4 / 17.5
Note	

Ordering data

Screw connection	Type	Qty.	Order No.
Tension-clamp connection	WAS5 CCC 0-20/0-20mA	1	8540180000
	WAZ5 CCC 0-20/0-20mA	1	8540190000

Screw connection	Type	Qty.	Order No.
	WAS5 CCC 0-20/4-20mA	1	8540250000

Screw connection	Type	Qty.	Order No.
	WAS5 CCC 0-20/4-20mA	1	8540250000

Note

Note

Note

Accessories

Note

Cross-connectors for power supplies and markers: refer to accessories

Cross-connectors for power supplies and markers: refer to accessories

10 Hz limiting frequency

- Signal conversion
- Galvanic isolation between input/output signals and power supply
- Power supply can be cross-connected using plug-in jumpers

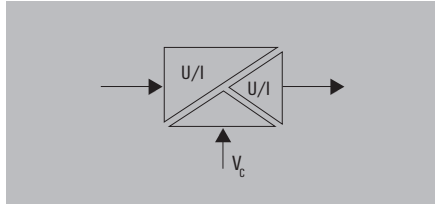

4...20 mA / 0...20 mA

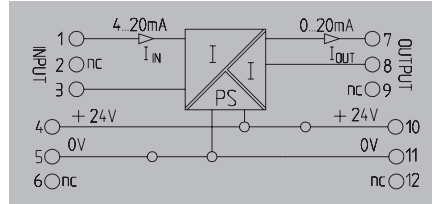

4...20 mA / 0...10 V

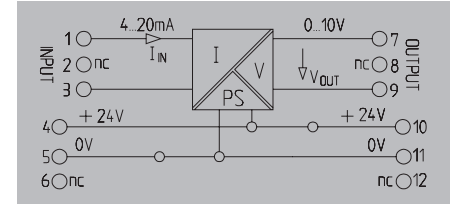

D

Technical data

Input	
Input voltage / Input current	/ 4...20 mA
Output	
Output voltage / Output current	/ 0...20 mA
Load impedance, voltage/current	/ ≤ 600 Ω
Cut-off frequency (-3 dB)	10 Hz
General data	
Configuration	none
Supply voltage	24 V DC ± 25 %
Power consumption	< 1.5 W @ I _{OUT} = 20 mA
Current-carrying capacity of cross-connect.	≤ 2 A
Accuracy	0.2 %
Temperature coefficient	± 250 ppm/K
Step response time	≤ 45 ms
Ambient temperature	0 °C...+55 °C
Approvals	CE; cULus; GOSTME25
Insulation coordination	
Standards	DIN EN 50178, DIN EN 61000-4-2
EMC standards	EN 55011, EN 61000-6
Rated voltage	300 V
Impulse withstand voltage	4 kV
Insulation voltage	2 kV _{eff} / 5 s
Overvoltage category	III
Pollution degree	2
Clearance & creepage distances	≥ 3 mm

		/ 4...20 mA
		/ 0...20 mA
		/ ≤ 600 Ω
		10 Hz
		none
		24 V DC ± 25 %
		< 1.5 W @ I _{OUT} = 20 mA
		≤ 2 A
		0.2 %
		± 250 ppm/K
		≤ 45 ms
		0 °C...+55 °C
		CE; cULus; GOSTME25
		DIN EN 50178, DIN EN 61000-4-2
		EN 55011, EN 61000-6
		300 V
		4 kV
		2 kV _{eff} / 5 s
		III
		2
		≥ 3 mm

		/ 4...20 mA
		0...10 V /
		≥ 1 kΩ /
		10 Hz
		none
		24 V DC ± 25 %
		< 1.3 W @ I _{OUT} = 5 mA
		≤ 2 A
		0.2 %
		± 250 ppm/K
		≤ 45 ms
		0 °C...+55 °C
		CE; cULus; GOSTME25
		DIN EN 50178, DIN EN 61000-4-2
		EN 55011, EN 61000-6
		300 V
		4 kV
		2 kV _{eff} / 5 s
		III
		2
		≥ 3 mm

Dimensions	
Clamping range (nominal / min. / max.)	mm ²
Depth x width x height	mm
Note	

Screw connection	
	2.5 / 0.5 / 2.5
	112.4 / 17.5
Note	

Screw connection	
	2.5 / 0.5 / 2.5
	112.4 / 17.5
Note	

Ordering data

	Screw connection
--	------------------

Type	Qty.	Order No.
WAS5 CCC 4-20/0-20MA	1	854020000

Type	Qty.	Order No.
WAS5 CVC 4-20mA/0-10V	1	8540230000

Note	
-------------	--

Note	
-------------	--

Note	
-------------	--

Accessories

Note	
-------------	--

Note	Cross-connectors for power supplies and markers: refer to accessories
-------------	---

Note	Cross-connectors for power supplies and markers: refer to accessories
-------------	---

10 Hz limiting frequency

- Signal conversion
- Galvanic isolation between input/output signals and power supply
- Power supply can be cross-connected using plug-in jumpers

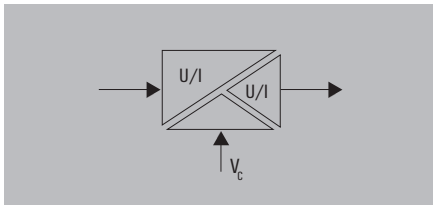

0...10 V / 0...20 mA

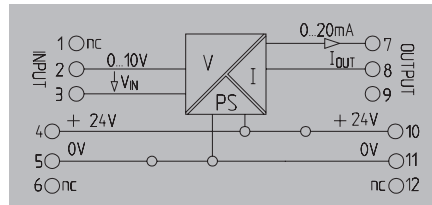

0...10 V / 4...20 mA

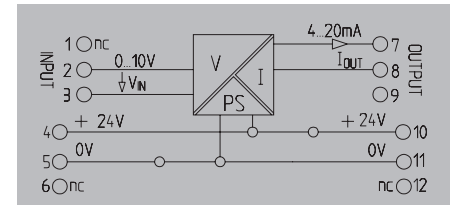

Technical data

Input	
Input voltage / Input current	
Output	
Output voltage / Output current	
Load impedance, voltage/current	
Cut-off frequency (-3 dB)	
General data	
Configuration	
Supply voltage	
Power consumption	
Accuracy	
Temperature coefficient	
Step response time	
Ambient temperature	
Approvals	
Insulation coordination	
Standards	
EMC standards	
Rated voltage	
Impulse withstand voltage	
Insulation voltage	
Overvoltage category	
Pollution degree	
Clearance & creepage distances	

0...10 V /
/ 0...20 mA
/ ≤ 600 Ω
10 Hz
none
24 V DC ± 25 %
< 1.5 W @ I _{OUT} = 20 mA
0.2 %
± 250 ppm/K
≤ 45 ms
0 °C...+55 °C
CE; cULus
DIN EN 50178, DIN EN 61000-4-2
EN 55011, EN 61000-6
300 V
4 kV
2 kV _{eff} / 5 s
III
2
≥ 3 mm

0...10 V /
/ 4...20 mA
/ ≤ 600 Ω
10 Hz
none
24 V DC ± 25 %
< 1.5 W @ I _{OUT} = 20 mA
0.2 %
± 250 ppm/K
≤ 45 ms
0 °C...+55 °C
CE; cULus
DIN EN 50178, DIN EN 61000-4-2
EN 55011, EN 61000-6
300 V
4 kV
2 kV _{eff} / 5 s
III
2
≥ 3 mm

Dimensions	
Clamping range (nominal / min. / max.)	mm ²
Depth x width x height	mm
Note	

Screw connection	Tension-clamp connection
2.5 / 0.5 / 2.5	1.5 / 0.5 / 2.5
112.4 / 17.5	112.4 / 17.5

Screw connection	Tension-clamp connection
2.5 / 0.5 / 2.5	1.5 / 0.5 / 2.5
112.4 / 17.5	112.4 / 17.5

Ordering data

Screw connection
Tension-clamp connection

Type	Qty.	Order No.
WAS5 VCC 0-10V/0-20MA	1	8540310000
WAZ5 VCC 0-10V/0-20MA	1	8540320000

Type	Qty.	Order No.
WAS5 VCC 0-10V/4-20MA	1	8540290000
WAZ5 VCC 0-10V/4-20MA	1	8540300000

Note

Accessories

Note

Note

Cross-connectors for power supplies and markers: refer to accessories

Note

Cross-connectors for power supplies and markers: refer to accessories

10 Hz limiting frequency

- Signal conversion
- Galvanic isolation between input/output signals and power supply
- Power supply can be cross-connected using plug-in jumpers

0...10 V / 0...10 V

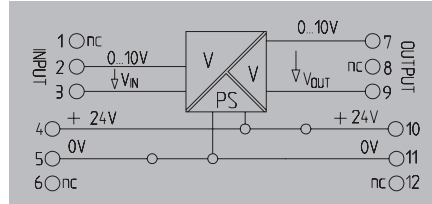
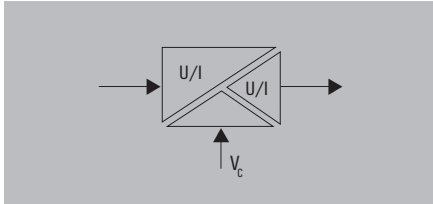

D

Technical data

Input	
Input voltage / Input current	0...10 V /
Output	
Output voltage / Output current	0...10 V /
Load impedance, voltage/current	≥ 1 kΩ /
Cut-off frequency (-3 dB)	10 Hz
General data	
Configuration	none
Supply voltage	24 V DC ± 25 %
Power consumption	< 1.3 W @ I _{OUT} = 5 mA
Current-carrying capacity of cross-connect.	≤ 2 A
Accuracy	0.2 %
Temperature coefficient	± 250 ppm/K
Step response time	≤ 45 ms
Ambient temperature	0 °C...+55 °C
Approvals	CE, cULus
Insulation coordination	
Standards	DIN EN 50178, DIN EN 61000-4-2
EMC standards	EN 55011, EN 61000-6
Rated voltage	300 V
Impulse withstand voltage	4 kV
Insulation voltage input or output/supply	2 kV _{eff} / 5 s
Overvoltage category	III
Pollution degree	2
Clearance & creepage distances	≥ 3 mm

	0...10 V /
	0...10 V /
	≥ 1 kΩ /
	10 Hz
	none
	24 V DC ± 25 %
	< 1.3 W @ I _{OUT} = 5 mA
	≤ 2 A
	0.2 %
	± 250 ppm/K
	≤ 45 ms
	0 °C...+55 °C
	CE, cULus
	DIN EN 50178, DIN EN 61000-4-2
	EN 55011, EN 61000-6
	300 V
	4 kV
	2 kV _{eff} / 5 s
	III
	2
	≥ 3 mm

Dimensions	
Clamping range (nominal / min. / max.)	mm ²
Depth x width x height	mm
Note	

Screw connection	Tension-clamp connection
2.5 / 0.5 / 2.5	1.5 / 0.5 / 2.5
112.4 / 17.5	112.4 / 17.5

Ordering data

	Screw connection
	Tension-clamp connection

Type	Qty.	Order No.
WAS5 VVC 0-10V/0-10V	1	8540330000
WAZ5 VVC 0-10V/0-10V	1	8540340000

Note	
-------------	--

Accessories

Note	Cross-connectors for power supplies and markers: refer to accessories
-------------	---

Output-side supply

- Signal conversion
- Galvanic isolation between input and output signals
- Power supply can be cross-connected using plug-in jumpers

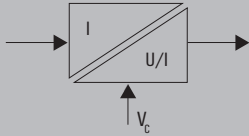

4...20 mA / 4...20 mA

UL Class I, Div. 2

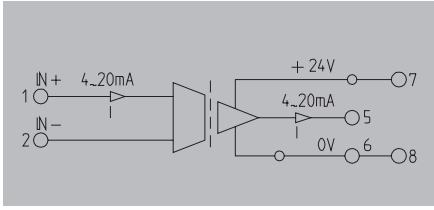

4...20 mA / 0...20 mA

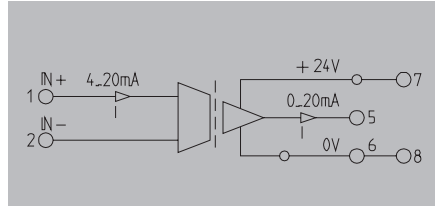

D

Technical data

Input	Input voltage / Input current
Output	Output voltage / Output current Load impedance, voltage/current Cut-off frequency (-3 dB)
General data	Configuration Supply voltage Current consumption Current-carrying capacity of cross-connect. Accuracy Temperature coefficient Step response time Ambient temperature Approvals
Insulation coordination	Standards EMC standards Rated voltage Impulse withstand voltage Insulation voltage Overvoltage category Pollution degree Clearance & creepage distances

Input	/ 4...20 mA (current loop)
Output	/ 4...20 mA / ≤ 500 Ω ≥ 15 Hz (typ. 20 Hz)
General data	none 24 V DC ± 20 % < 32 mA @ I _{OUT} = 20 mA ≤ 2 A ± 0.2 % of final value ≤ 250 ppm/K of final value ≤ 30 ms (typ. 20 ms) 0 °C...+55 °C CE, CSA, cULus
Insulation coordination	DIN EN 50178, DIN EN 61000-4-2 EN 55011, EN 61000-6 300 V 4 kV 1.2 kV _{eff} / 5 s III 2 ≥ 3 mm

Input	/ 4...20 mA (current loop)
Output	/ 0...20 mA / ≤ 500 Ω ≥ 15 Hz (typ. 20 Hz)
General data	none 24 V DC ± 20 % < 32 mA @ I _{OUT} = 20 mA ≤ 2 A ± 0.2 % of final value ≤ 250 ppm/K of final value ≤ 30 ms (typ. 20 ms) 0 °C...+55 °C CE, CSA, cULus, GOSTME25
Insulation coordination	DIN EN 50178, DIN EN 61000-4-2 EN 55011, EN 61000-6 300 V 4 kV 1.2 kV _{eff} / 5 s III 2 ≥ 3 mm

Dimensions	
Clamping range (nominal / min. / max.)	mm ²
Depth x width x height	mm
Note	

Screw connection	Tension-clamp connection
2.5 / 0.5 / 2.5	1.5 / 0.5 / 2.5
112.4 / 12.5	112.4 / 12.5
Note	

Screw connection	
2.5 / 0.5 / 2.5	
112.4 / 12.5	
Note	

Ordering data

	Screw connection
	Tension-clamp connection
Note	

Type	Qty.	Order No.
WAS4 CCC DC 4-20/4-20MA	1	8444980000
WAZ4 CCC DC 4-20/4-20MA	1	8444990000

Type	Qty.	Order No.
WAS4 CCC DC 4-20/0-20MA	1	8445010000

Accessories

Note	
-------------	--

Cross-connector for power supplies and markers - refer to Accessories

Cross-connector for power supplies and markers - refer to Accessories

Signal distributor

Supplied by current loop

- Galvanic isolation
- Input and output current loop feed
- Very low power consumption
- No calibration necessary

20LP

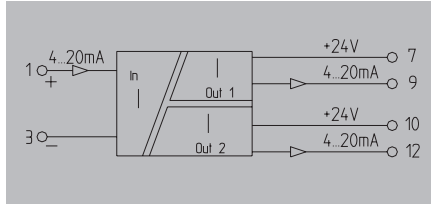
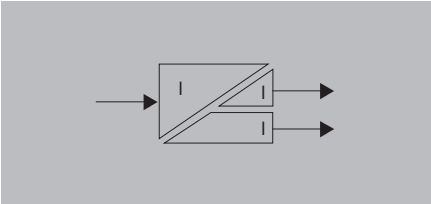

D

Technical data

Input	
Input current	4...20 mA (current loop)
Voltage drop	3.8 V
Output	
Output current	2 x 4...20 mA (current loop)
Output signal limit	Approx. 31 mA
Load impedance, voltage/current	/ $R_L = (U_E - 12 V) / 20 \text{ mA}$ z.B. 600 Ω at 24 V
Cut-off frequency (-3 dB)	30 Hz
General data	
Configuration	none
Supply voltage	min. 12 V DC/ max. 30 V DC
Accuracy	typ. 0.1 %; max. 0.2 %
Temperature coefficient	$\leq 150 \text{ ppm/K}$
Step response time	$< 20 \text{ ms}$
Ambient temperature	0 °C...+55 °C
Approvals	CE, cULus
Insulation coordination	
Standards	DIN EN 50178, DIN EN 61000-4-2
EMC standards	EN 55011, EN 61000-6
Rated voltage	300 V
Impulse withstand voltage	4 kV
Insulation voltage input or output/supply	4 kV _{eff} / 5 s
Overvoltage category	III
Pollution degree	2
Clearance & creepage distances	$\geq 5.5 \text{ mm}$

Example of application

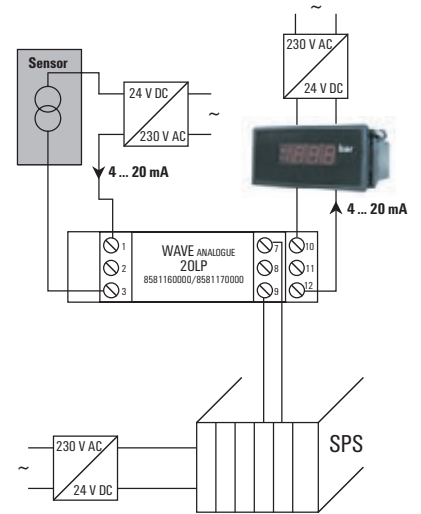

Dimensions	
Clamping range (nominal / min. / max.)	mm ²
Depth x width x height	mm
Note	

Screw connection	Tension-clamp connection
2.5 / 0.5 / 2.5	1.5 / 0.5 / 2.5
112.4 / 17.5	112.4 / 17.5

Ordering data

	Screw connection
	Tension-clamp connection

Type	Qty.	Order No.
WAS5 CCC 20LP	1	8581160000
WAZ5 CCC 20LP	1	8581170000

Note

Accessories

Note

Markers - refer to Accessories.

Signal distributor

Supplied by current loop

- Galvanic isolation
- Input and output current loop feed
- Very low power consumption
- No calibration necessary
- ATEX II 3 G Ex nA IIC T4
- UL Class I, Div. 2

20LP

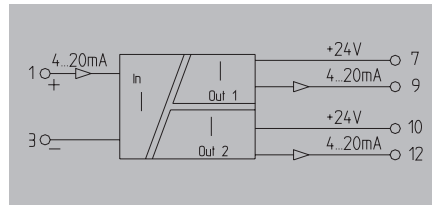
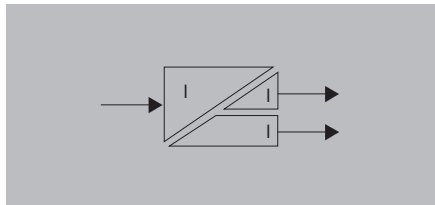

Technical data

Input	
Input current	4...20 mA (current loop)
Voltage drop	3.8 V
Output	
Output current	2 x 4...20 mA (current loop)
Output signal limit	Approx. 31 mA
Load impedance, voltage/current	/ $R_L = (U_E - 12 V) / 20 \text{ mA}$ z.B. 600 Ω at 24 V
Cut-off frequency (-3 dB)	30 Hz
General data	
Configuration	none
Supply voltage	min. 12 V DC/ max. 30 V DC
Accuracy	typ. 0.1 %; max. 0.2 %
Temperature coefficient	$\leq 150 \text{ ppm/K}$
Step response time	$< 20 \text{ ms}$
Ambient temperature	0 °C...+55 °C
Approvals	CE; cULusEX; DEMKOATEX; GOSTME25
Insulation coordination	
Standards	DIN EN 60079, DIN EN 61000-4-2
EMC standards	EN 55011, EN 61000-6
Rated voltage	300 V
Impulse withstand voltage	4 kV
Insulation voltage input or output/supply	4 kV _{eff} / 5 s
Overvoltage category	III
Pollution degree	2
Clearance & creepage distances	$\geq 5.5 \text{ mm}$

Dimensions	
Clamping range (nominal / min. / max.)	mm ²
Depth x width x height	mm
Note	

Ordering data

Screw connection

Note

Accessories

Note

Screw connection		
	2.5 / 0.5 / 2.5	
	112.4 / 17.5	

Type	Qty.	Order No.
WAS5 CCC 20LP EX	1	8975640000

Note

Markers - refer to Accessories.

Example of application

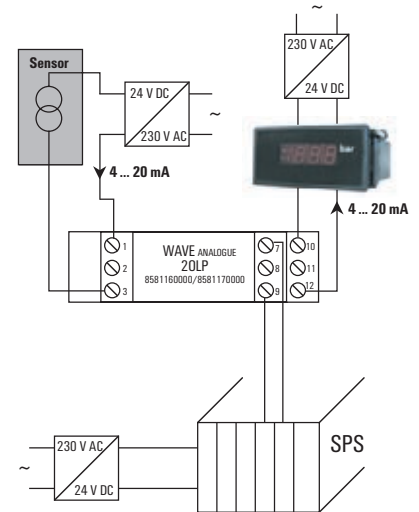

Output-current loop-powered

- Galvanic isolation
- Very low power consumption
- Input range selected via DIP switch
- No calibration necessary

O/P

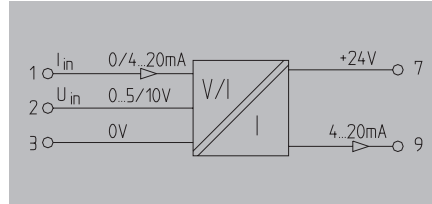
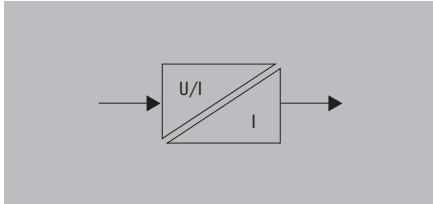

Technical data

Input	
Input voltage	0...5 V; 210 kΩ; 0...10 V; 430 kΩ / 51 Ω
Input resistance, voltage/current	0...20 mA, 4...20mA
Input current	40 mA
Rated current	
Output	
Output current	4...20 mA (current loop)
Output signal limit	Approx. 31 mA
Load impedance, voltage/current	/ $R_L = (U_E - 12 V) / 20 mA$ z.B. 600 Ω at 24 V
Cut-off frequency (-3 dB)	10 Hz/ 100 Hz switchable
General data	
Configuration	DIP switch
Supply voltage	min. 12 V DC/ max. 30 V DC
Ambient temperature	0 °C...+55 °C
Default setting	0...20mA, 10 Hz
Accuracy	0.2% of measuring range final value
Temperature coefficient	≤ 150 ppm/K
Step response time	< 10 Hz: 80 ms; 100 Hz: 50 ms
Approvals	CE; cULus
Insulation coordination	
Standards	DIN EN 50178, DIN EN 61000-4-2
EMC standards	EN 55011, EN 61000-6
Rated voltage	300 V
Impulse withstand voltage	4 kV
Insulation voltage	4 kV _{eff} / 5 s
Overvoltage category	III
Pollution degree	2
Clearance & creepage distances	≥ 5.5 mm

Dimensions	
Clamping range (nominal / min. / max.)	mm ²
Depth x width x height	mm
Note	

Ordering data

	Screw connection
	Tension-clamp connection
Note	

Accessories

Note	
------	--

Setting options/switch position	
	SW 1
Input	
0 ... 20 mA	<input type="checkbox"/> 1 <input type="checkbox"/> 2 <input type="checkbox"/> 3 <input type="checkbox"/> 4
4 ... 20 mA	<input checked="" type="checkbox"/> 1 <input type="checkbox"/> 2 <input type="checkbox"/> 3 <input type="checkbox"/> 4
0 ... 5 V	<input checked="" type="checkbox"/> 1 <input checked="" type="checkbox"/> 2 <input checked="" type="checkbox"/> 3 <input type="checkbox"/> 4
0 ... 10 V	<input type="checkbox"/> 1 <input checked="" type="checkbox"/> 2 <input type="checkbox"/> 3 <input type="checkbox"/> 4
Transmission frequency	
10 Hz	<input type="checkbox"/> 1 <input type="checkbox"/> 2 <input type="checkbox"/> 3 <input checked="" type="checkbox"/> 4
100 Hz	<input type="checkbox"/> 1 <input type="checkbox"/> 2 <input type="checkbox"/> 3 <input type="checkbox"/> 4
■ = on □ = off	
Example of application	

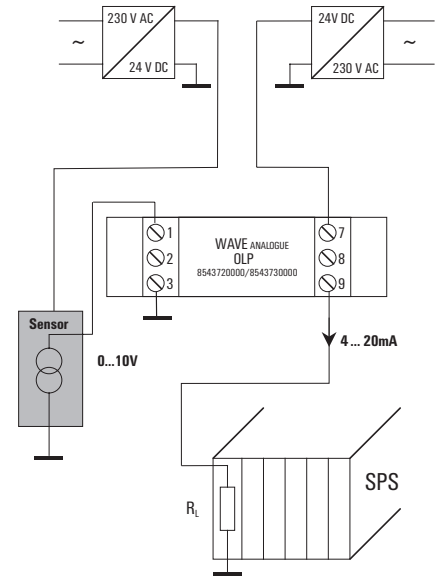

Screw connection	Tension-clamp connection
2.5 / 0.5 / 2.5	1.5 / 0.5 / 2.5
112.4 / 17.5	112.4 / 17.5
Note	

Type	Qty.	Order No.
WAS5 OLP	1	8543720000
WAZ5 OLP	1	8543730000
Note		

Note	
Markers - refer to Accessories.	

Input current loop feed

- Safe separation
- Very low power consumption
- UL Class I, Div. 2

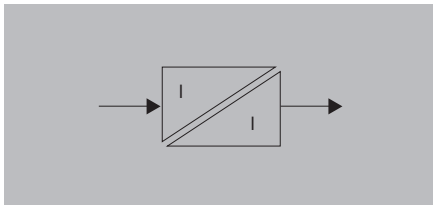

CCC LP

(1-channel)

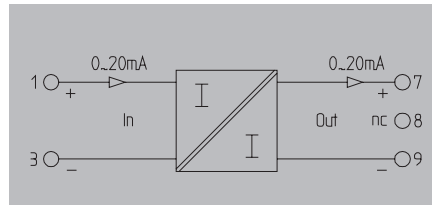

CCC LP

(2-channel)

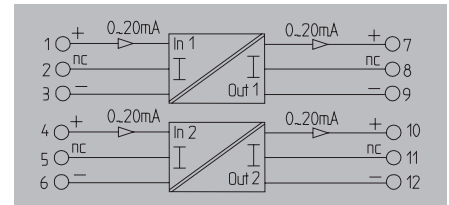

Technical data

Input	
Input voltage / Input current	
Pick-up current	
Voltage drop	
Output	
Output voltage / Output current	
Load impedance, voltage/current	
General data	
Configuration	
Ambient temperature	
Accuracy	
Temperature coefficient	
Approvals	
Insulation coordination	
Standards	
EMC standards	
Rated voltage	
Impulse withstand voltage	
Insulation voltage	
Overvoltage category	
Pollution degree	
Clearance & creepage distances	

/ 0(4)...20 mA current loop
< 100 µA
Approx. 3 V at $R_L = 0 \Omega$; approx. 13 V at $R_L = 500 \Omega$; ($I_N = 20 \text{ mA}$)
/ 0...20 mA, 4...20 mA
/ $\leq 500 \Omega$
none
-25 °C...+70 °C
< 0.1 % of end value
$\leq 50 \text{ ppm/K}$ of final value
CE; CSA; cULus; cULusEX; GL
DIN EN 50178, DIN EN 61000-4-2
EN 55011, EN 61000-6
300 V
6 kV
4 kV _{eff} / 1 s
III
2
$\geq 5.5 \text{ mm}$

/ 0(4)...20 mA current loop
< 100 µA
Approx. 3 V at $R_L = 0 \Omega$; approx. 13 V at $R_L = 500 \Omega$; ($I_N = 20 \text{ mA}$)
/ 0...20 mA, 4...20 mA
/ $\leq 500 \Omega$
none
-25 °C...+70 °C
< 0.1 % of end value
$\leq 50 \text{ ppm/K}$ of final value
CE; CSA; cULus; cULusEX; GL
DIN EN 50178, DIN EN 61000-4-2
EN 55011, EN 61000-6
300 V
6 kV
4 kV _{eff} / 1 s
III
2
$\geq 5.5 \text{ mm}$

Dimensions	
Clamping range (nominal / min. / max.)	mm ²
Depth x width x height	mm
Note	

Screw connection	Tension-clamp connection
2.5 / 0.5 / 2.5	1.5 / 0.5 / 2.5
112.4 / 17.5	112.4 / 17.5

Screw connection	Tension-clamp connection
2.5 / 0.5 / 2.5	1.5 / 0.5 / 2.5
112.4 / 17.5	112.4 / 17.5

Ordering data

Screw connection
Tension-clamp connection

Type	Qty.	Order No.
WAS5 CCC LP 0-20/0-20mA	1	8444950000
WAZ5 CCC LP 0-20/0-20mA	1	8444960000

Type	Qty.	Order No.
WAS5 CCC LP 0-20/0-20mA	1	8463580000
WAZ5 CCC LP 0-20/0-20mA	1	8463590000

Note

--

--

Accessories

Note

Markers - refer to Accessories.

Markers - refer to Accessories.

RTD signal isolator/converter

- Universally adjustable via DIP switch
- 3-way isolation
- Linearisation
- Power supply can be cross-connected using plug-in jumpers
- WAVETOOL software helps with configuration,download at www.weidmuller.com

PRO RTD

UL Class I, Div. 2

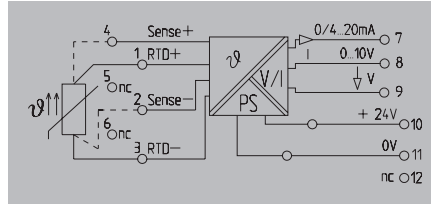
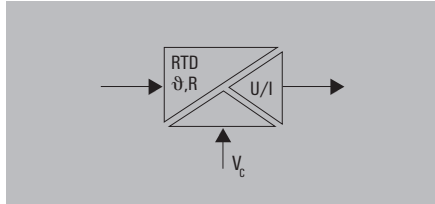

D

Technical data

Input

Sensor

Temperature input range

Output

- Output current / Output voltage
- Offset current / Offset voltage
- Load impedance, voltage/current
- Sensor error detection
- Fine adjustment
- Status indicator

General data

- Configuration
- Supply voltage
- Power consumption
- Step response time
- Ambient temperature
- Approvals

Insulation coordination

- Standards
- EMC standards
- Rated voltage
- Impulse withstand voltage
- Insulation voltage
- Overvoltage category
- Pollution degree
- Clearance & creepage distances

Input

PT100/2-/3-/4-wire, Ni100/2-/3-/4-wire, potentiometer: min. 0-100 Ω, max. 0-100 kΩ, resistance: 0-450 Ω

Configurable

Output

- 0...20 mA, 4...20 mA / 0...10 V
- max. 100 μA / max. 0.05 V
- ≥ 1 kΩ / ≤ 600 Ω
- LED flashing (output value: > 20 mA, >10 V)
- ≥ ± 5 %, Version 1 and later: ≥ 12.5 % / potentiometer: 12.5%...25%
- Module active: LED on/ wire breakage: LED flashing/ Error: LED off

General data

- DIP switch, Potentiometer
- 24 V DC ± 20 %
- 830...880...980mW at I_{OUT} = 20 mA
- fast/slow: 2-/3-/4-conductor: 1.2 s/2.2 s; potentiometer: 0.5 s/1.1 s
- 0 °C...+55 °C
- CE; cULus; GL

Insulation coordination

- DIN EN 50178, DIN EN 61000-4-2
- EN 55011, EN 61000-6
- 300 V
- 4 kV
- 2 kV_{eff} / 5 s
- III
- 2
- ≥ 3 mm

Dimensions

Clamping range (nominal / min. / max.)	mm ²
Depth x width x height	mm

Note

Screw connection Tension-clamp connection

2.5 / 0.5 / 2.5	1.5 / 0.5 / 2.5
112.4 / 17.5	112.4 / 17.5

Ordering data

	Screw connection
	Tension-clamp connection

Type	Qty.	Order No.
WAS5 PRO RTD	1	8560700000
WAZ5 PRO RTD	1	8560710000

Note

Accessories

Note

Cross-connector for power supplies and markers - refer to Accessories

PRO RTD

Switch position / setting options

Choice of inputs		Switch 1		
Input		1	2	3
PT100	2-wire	■	■	■
PT100	3-wire	□	■	■
PT100	4-wire	■	□	■
R	2-wire	□	□	■
NI100	2-wire	■	■	□
NI100	3-wire	□	■	□
NI100	4-wire	■	□	□
Potentiometer		□	□	□

■ = on
□ = off

Choice of minimum input size				Switch 1			
R_{min}	R_{min}	Poti _{min}		4	5	6	7
0 °C	0 Ω	0 %		■	■	■	■
-10 °C	10 Ω	10 %		■	■	■	□
-20 °C	20 Ω	20 %		■	■	□	■
-25 °C	20 Ω	25 %		■	■	□	□
-30 °C	30 Ω	30 %		■	□	■	■
-40 °C	40 Ω	40 %		■	□	■	□
-50 °C	50 Ω	50 %		■	□	□	■
-60 °C	60 Ω	60 %		■	□	□	□
-70 °C	70 Ω	70 %		□	■	■	■
-80 °C	80 Ω	80 %		□	■	■	□
-90 °C	90 Ω			□	■	□	■
-100 °C	100 Ω			□	■	□	□
-150 °C	150 Ω			□	□	■	■
-200 °C	200 Ω			□	□	■	□
Special area				□	□	□	■

Choice of measuring range			Switch 2				
T	R	Poti	1	2	3	4	5
40 K	20 Ω	20 %	■	■	■	■	■
50 K	25 Ω	25 %	■	■	■	■	□
60 K	30 Ω	30 %	■	■	■	□	■
70 K	35 Ω	35 %	■	■	■	□	□
80 K	40 Ω	40 %	■	■	□	■	■
90 K	45 Ω	45 %	■	■	□	■	□
100 K	50 Ω	50 %	■	■	□	□	■
110 K	55 Ω	55 %	■	■	□	□	□
120 K	60 Ω	60 %	■	□	■	■	■
125 K	62.5 Ω	62.5 %	■	□	■	■	□
130 K	65 Ω	65 %	■	□	■	□	■
140 K	70 Ω	70 %	■	□	□	□	□
150 K	75 Ω	75 %	■	□	□	■	■
160 K	80 Ω	80 %	■	□	□	■	□
170 K	85 Ω	85 %	■	□	□	□	■
180 K	90 Ω	90 %	■	□	□	□	□
190 K	95 Ω	95 %	□	■	■	■	■
200 K	100 Ω	100 %	□	■	■	■	□
250 K	125 Ω	-	□	□	■	■	■
300 K	150 Ω	-	□	□	■	□	□
350 K	175 Ω	-	□	■	□	■	■
400 K	200 Ω	-	□	■	□	■	□
450 K	225 Ω	-	□	■	□	□	■
500 K	250 Ω	-	□	■	□	□	□
550 K	275 Ω	-	□	□	■	■	■
600 K	300 Ω	-	□	□	■	■	□
650 K	325 Ω	-	□	□	■	□	■
700 K	350 Ω	-	□	□	■	□	□
750 K	375 Ω	-	□	□	□	■	■
800 K	400 Ω	-	□	□	□	■	□
850 K	425 Ω	-	□	□	□	□	■
900 K	450 Ω	-	□	□	□	□	□

Choice of outputs		Switch 2	
Output		6	7
0...10 V		■	□
0...5 V		■	■
0...20 mA		□	□
4...20 mA		□	■

Switch on the manual fine adjustments		S. 1
Man. adjustment		8
off		□
on		■

Choice of step response time		S. 2
Step response time		8
slow		■
fast		□

Accuracy, slow/fast step response time

PT 100, Ni 100: 0.3 % from measuring range 0.8 %
from measuring range < 100 K / 0.3 K / 0.8 K
Potentiometer: 0.2 % from end value / 0.3 %
Resistance: 0.2 % from end value / 0.3 %

Temperature coefficient

Measuring range ≥ 200 K	≤ 200 ppm / °C
100 K ≤ Measuring range < 200 K	≤ 250 ppm / °C
40 K ≤ Measuring range < 100 K	≤ 400 ppm / °C

Adjustment example for zero and span

Temperature adjustment:	
Output	4...20 mA
DIP switch	-10 °C...+110 °C
Span	75...110 °C
Range	120 °C
Adjustment range	± 12.5 %

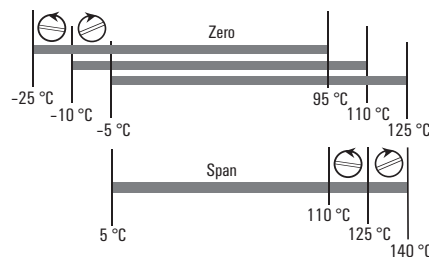

Wavetool adjustment tool

This service tool enables quick and straightforward configuration of the WAVE^{ANALOG} PRO.

Internet download:
<http://www.weidmueller.com>

RTD signal isolator/converter

- Universally adjustable via DIP switch
- 3-way isolation
- Linearisation
- Power supply can be cross-connected using plug-in jumpers

PRO RTD 1000

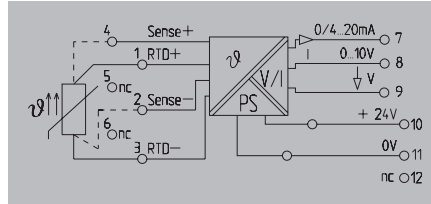
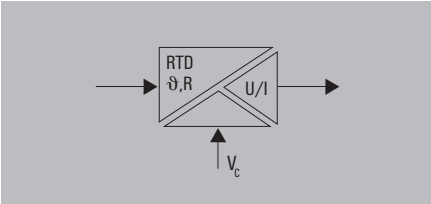

D

Technical data

Input

Sensor

Temperature input range

Output

- Output current / Output voltage
- Offset current / Offset voltage
- Load impedance, voltage/current
- Sensor error detection
- Fine adjustment
- Status indicator

General data

- Configuration
- Supply voltage
- Power consumption
- Step response time
- Ambient temperature
- Approvals

Insulation coordination

- Standards
- EMC standards
- Rated voltage
- Impulse withstand voltage
- Insulation voltage
- Overvoltage category
- Pollution degree
- Clearance & creepage distances

Ni1000/2-/3-/4-wire, Potentiometer: min. 0-1kΩ, max. 0-100kΩ, PT1000/2-/3-/4-wire, Resistance: 0-4.5kΩ

Configurable

0...20 mA, 4...20 mA / 0...10 V

max. 100 μA / max. 0.05 V

≥ 1 kΩ / ≤ 600 Ω

LED flashing (output value: > 20 mA, >10 V)

± 12.5 % of FSR; potentiometer: ± 12.5 % ... ± 25 %

Module active: LED on/ wire breakage: LED flashing/
Error: LED off

DIP switch, Potentiometer

24 V DC ± 20 %

830...880...980mW at I_{OUT} = 20 mA

Fast/slow:2-/3-/4-conductor: 1.2s/2.3s; potentiometer: 0.5s/1.2s

0 °C...+55 °C

CE; cULus; GL; GOSTME25

DIN EN 50178, DIN EN 61000-4-2

EN 55011, EN 61000-6

300 V

4 kV

2 kV_{eff} / 5 s

III

2

≥ 3 mm

Dimensions

Clamping range (nominal / min. / max.) mm²

Depth x width x height mm

Note

Screw connection

2.5 / 0.5 / 2.5

112.4 / 17.5

Ordering data

Screw connection

Type	Qty.	Order No.
WAS5 PRO RTD 1000	1	8679490000

Note

Accessories

Note

Cross-connector for power supplies and markers - refer to Accessories

PRO RTD 1000

Switch position / setting options

Choice of inputs		Switch 1		
Input		1	2	3
PT1000	2-wire	■	■	■
PT1000	3-wire	□	■	■
PT1000	4-wire	■	□	■
R	2-wire	□	□	■
NI1000	2-wire	■	■	□
NI1000	3-wire	□	■	□
NI1000	4-wire	■	□	□
Potentiometer		□	□	□

■ = on
□ = off

Choice of minimum input size				Switch 1			
R_{min}	R_{min}	Poti _{min}		4	5	6	7
0 °C	0 Ω	0 %		■	■	■	■
-10 °C	100 Ω	10 %		■	■	■	□
-20 °C	200 Ω	20 %		■	■	□	■
-25 °C	200 Ω	25 %		■	■	□	□
-30 °C	300 Ω	30 %		■	□	■	■
-40 °C	400 Ω	40 %		■	□	■	□
-50 °C	500 Ω	50 %		■	□	□	■
-60 °C	600 Ω	60 %		■	□	□	□
-70 °C	700 Ω	70 %		□	■	■	■
-80 °C	800 Ω	80 %		□	■	■	□
-90 °C	900 Ω			□	■	□	■
-100 °C	1000 Ω			□	■	□	□
-150 °C	1500 Ω			□	□	■	■
-200 °C	2000 Ω			□	□	■	□
Special area				□	□	□	■

Choice of measuring range			Switch 2				
T	R	Poti	1	2	3	4	5
40 K	200 Ω	20 %	■	■	■	■	■
50 K	250 Ω	25 %	■	■	■	■	□
60 K	300 Ω	30 %	■	■	■	□	■
70 K	350 Ω	35 %	■	■	■	□	□
80 K	400 Ω	40 %	■	■	□	■	■
90 K	450 Ω	45 %	■	■	□	■	□
100 K	500 Ω	50 %	■	■	□	□	■
110 K	550 Ω	55 %	■	■	□	□	□
120 K	600 Ω	60 %	■	□	■	■	■
125 K	625 Ω	62.50 %	■	□	■	■	□
130 K	650 Ω	65 %	■	□	■	□	■
140 K	700 Ω	70 %	■	□	□	□	□
150 K	750 Ω	75 %	■	□	□	■	■
160 K	800 Ω	80 %	■	□	□	■	□
170 K	850 Ω	85 %	■	□	□	□	■
180 K	900 Ω	90 %	■	□	□	□	□
190 K	950 Ω	95 %	□	■	■	■	■
200 K	1000 Ω	100 %	□	■	■	■	□
250 K	1250 Ω	-	□	□	■	■	■
300 K	1500 Ω	-	□	□	■	□	□
350 K	1750 Ω	-	□	■	□	■	■
400 K	2000 Ω	-	□	■	□	■	□
450 K	2250 Ω	-	□	■	□	□	■
500 K	2500 Ω	-	□	■	□	□	□
550 K	2750 Ω	-	□	□	■	■	■
600 K	3000 Ω	-	□	□	■	■	□
650 K	3250 Ω	-	□	□	■	□	■
700 K	3500 Ω	-	□	□	□	■	□
750 K	3750 Ω	-	□	□	□	■	■
800 K	4000 Ω	-	□	□	□	■	□
850 K	4250 Ω	-	□	□	□	■	■
900 K	4500 Ω	-	□	□	□	□	□

Choice of outputs		Switch 2	
Output		6	7
0...10 V		■	□
0...5 V		■	■
0...20 mA		□	□
4...20 mA		□	■

Switch on the manual fine adjustments		S. 1
Man. adjustment		8
off		□
on		■

Choice of step response time		S. 2
Step response time		8
slow		■
fast		□

Accuracy, slow/fast step response time

PT 100, Ni 100: 0.3 % from measuring range 0.8 %
from measuring range < 100 K / 0.3 K / 0.8 K
Potentiometer: 0.2 % from end value / 0.3 %
Resistance: 0.2 % from end value / 0.3 %

Temperature coefficient

Measuring range ≥ 200 K	≤ 200 ppm / °C
100 K ≤ Measuring range < 200 K	≤ 250 ppm / °C
40 K ≤ Measuring range < 100 K	≤ 400 ppm / °C

Adjustment example for zero and span

Temperature adjustment:	
Output	4...20 mA
DIP switch	-10 °C...+110 °C
Span	75...110 °C
Range	120 °C
Adjustment range	± 12.5 %

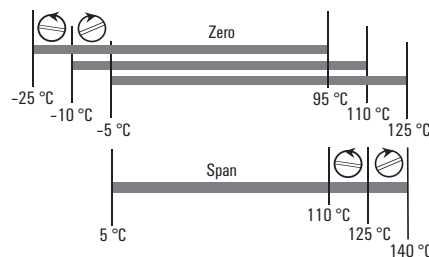

Wavetool adjustment tool

This service tool enables quick and straightforward configuration of the WAVE_{ANALDG} PRO.

Internet download:
<http://www.weidmueller.com>

RTD signal isolator/converter

- Universally adjustable via DIP switch
- 3-way isolation
- Linearisation
- Power supply can be cross-connected using plug-in jumpers.

PRO RTD Cu

UL Class I, Div.2

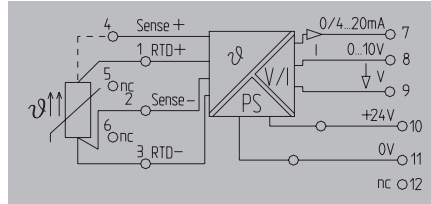
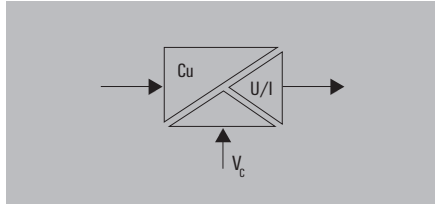

Technical data

Input	
Sensor	Cu
Temperature input range	Adjustable from -200...+260°C
Output	
Output current / Output voltage	0...20 mA, 4...20 mA / 0...10 V
Offset current / Offset voltage	max. 100 µA / max. 0.05 V
Load impedance, voltage/current	≥ 1 kΩ / ≤ 600 Ω
Sensor error detection	LED flashing (output value: > 20 mA, >10 V)
Fine adjustment	± 12.5% of FSR
Status indicator	Module active: LED on/ wire breakage: LED flashing/ Error: LED off
General data	
Configuration	DIP switch
Supply voltage	24 V DC ± 20 %
Power consumption	880...980...1030mW at I _{out} = 20 mA
Step response time	Fast: 1.2 s/ slow: 2.2 s
Ambient temperature	0 °C...+55 °C
Approvals	CE; cULus; cULusEX; GOSTME25
Insulation coordination	
Standards	DIN EN 50178, DIN EN 61000-4-2
EMC standards	EN 55011, EN 61000-6
Rated voltage	300 V
Impulse withstand voltage	4 kV
Insulation voltage	2 kV _{eff} / 5 s
Overvoltage category	III
Pollution degree	2
Clearance & creepage distances	≥ 3 mm
Dimensions	
Clamping range (nominal / min. / max.)	mm ²
Depth x width x height	mm
Note	

Screw connection		
2.5 / 0.5 / 2.5		
112.4 / 17.5		
Type		
WAS5 PRO RTD Cu	Qty. 1	Order No. 8638950000

Ordering data

Screw connection

Note

Accessories

Cross-connector for power supplies and markers - refer to Accessories

Connection	Selection of connection Switch 1		Selection of sensor Switch 1	
	1	2	2	3
3-wire	<input checked="" type="checkbox"/>	<input type="checkbox"/>	Cu 10	<input checked="" type="checkbox"/>
4-wire	<input type="checkbox"/>	<input type="checkbox"/>	Cu 25	<input checked="" type="checkbox"/>
			Cu 50	<input type="checkbox"/>
			Cu 100	<input type="checkbox"/>

° min	Selection of minimum input values Switch 1			
	4	5	6	7
- 0 °C	<input checked="" type="checkbox"/>	<input checked="" type="checkbox"/>	<input checked="" type="checkbox"/>	<input checked="" type="checkbox"/>
- 10 °C	<input checked="" type="checkbox"/>	<input checked="" type="checkbox"/>	<input checked="" type="checkbox"/>	<input type="checkbox"/>
- 20 °C	<input checked="" type="checkbox"/>	<input checked="" type="checkbox"/>	<input type="checkbox"/>	<input checked="" type="checkbox"/>
- 25 °C	<input checked="" type="checkbox"/>	<input checked="" type="checkbox"/>	<input type="checkbox"/>	<input type="checkbox"/>
- 30 °C	<input checked="" type="checkbox"/>	<input type="checkbox"/>	<input checked="" type="checkbox"/>	<input checked="" type="checkbox"/>
- 40 °C	<input checked="" type="checkbox"/>	<input type="checkbox"/>	<input checked="" type="checkbox"/>	<input type="checkbox"/>
- 50 °C	<input checked="" type="checkbox"/>	<input type="checkbox"/>	<input type="checkbox"/>	<input type="checkbox"/>
- 60 °C	<input checked="" type="checkbox"/>	<input type="checkbox"/>	<input type="checkbox"/>	<input type="checkbox"/>
- 70 °C	<input type="checkbox"/>	<input checked="" type="checkbox"/>	<input checked="" type="checkbox"/>	<input checked="" type="checkbox"/>
- 80 °C	<input type="checkbox"/>	<input checked="" type="checkbox"/>	<input checked="" type="checkbox"/>	<input type="checkbox"/>
- 90 °C	<input type="checkbox"/>	<input checked="" type="checkbox"/>	<input type="checkbox"/>	<input checked="" type="checkbox"/>
- 100 °C	<input type="checkbox"/>	<input checked="" type="checkbox"/>	<input type="checkbox"/>	<input type="checkbox"/>
- 150 °C	<input type="checkbox"/>	<input type="checkbox"/>	<input checked="" type="checkbox"/>	<input checked="" type="checkbox"/>
- 200 °C	<input type="checkbox"/>	<input type="checkbox"/>	<input checked="" type="checkbox"/>	<input type="checkbox"/>
special range	<input type="checkbox"/>	<input type="checkbox"/>	<input type="checkbox"/>	<input type="checkbox"/>

Span	Selection of the measurement range Switch 2				
	1	2	3	4	5
40 K	<input checked="" type="checkbox"/>	<input checked="" type="checkbox"/>	<input checked="" type="checkbox"/>	<input checked="" type="checkbox"/>	<input checked="" type="checkbox"/>
50 K	<input checked="" type="checkbox"/>	<input checked="" type="checkbox"/>	<input checked="" type="checkbox"/>	<input checked="" type="checkbox"/>	<input type="checkbox"/>
60 K	<input checked="" type="checkbox"/>	<input checked="" type="checkbox"/>	<input checked="" type="checkbox"/>	<input type="checkbox"/>	<input checked="" type="checkbox"/>
70 K	<input checked="" type="checkbox"/>	<input checked="" type="checkbox"/>	<input checked="" type="checkbox"/>	<input type="checkbox"/>	<input type="checkbox"/>
80 K	<input checked="" type="checkbox"/>	<input checked="" type="checkbox"/>	<input type="checkbox"/>	<input checked="" type="checkbox"/>	<input checked="" type="checkbox"/>
90 K	<input checked="" type="checkbox"/>	<input checked="" type="checkbox"/>	<input type="checkbox"/>	<input checked="" type="checkbox"/>	<input type="checkbox"/>
100 K	<input checked="" type="checkbox"/>	<input checked="" type="checkbox"/>	<input type="checkbox"/>	<input type="checkbox"/>	<input checked="" type="checkbox"/>
110 K	<input checked="" type="checkbox"/>	<input checked="" type="checkbox"/>	<input type="checkbox"/>	<input type="checkbox"/>	<input type="checkbox"/>
120 K	<input checked="" type="checkbox"/>	<input type="checkbox"/>	<input checked="" type="checkbox"/>	<input checked="" type="checkbox"/>	<input checked="" type="checkbox"/>
125 K	<input checked="" type="checkbox"/>	<input type="checkbox"/>	<input checked="" type="checkbox"/>	<input checked="" type="checkbox"/>	<input type="checkbox"/>
130 K	<input checked="" type="checkbox"/>	<input type="checkbox"/>	<input checked="" type="checkbox"/>	<input type="checkbox"/>	<input type="checkbox"/>
140 K	<input checked="" type="checkbox"/>	<input type="checkbox"/>	<input checked="" type="checkbox"/>	<input type="checkbox"/>	<input type="checkbox"/>
150 K	<input checked="" type="checkbox"/>	<input type="checkbox"/>	<input type="checkbox"/>	<input checked="" type="checkbox"/>	<input checked="" type="checkbox"/>
160 K	<input checked="" type="checkbox"/>	<input type="checkbox"/>	<input type="checkbox"/>	<input checked="" type="checkbox"/>	<input type="checkbox"/>
170 K	<input checked="" type="checkbox"/>	<input type="checkbox"/>	<input type="checkbox"/>	<input type="checkbox"/>	<input checked="" type="checkbox"/>
180 K	<input checked="" type="checkbox"/>	<input type="checkbox"/>	<input type="checkbox"/>	<input type="checkbox"/>	<input type="checkbox"/>
190 K	<input type="checkbox"/>	<input checked="" type="checkbox"/>	<input checked="" type="checkbox"/>	<input checked="" type="checkbox"/>	<input checked="" type="checkbox"/>
200 K	<input type="checkbox"/>	<input checked="" type="checkbox"/>	<input checked="" type="checkbox"/>	<input checked="" type="checkbox"/>	<input type="checkbox"/>
210 K	<input type="checkbox"/>	<input checked="" type="checkbox"/>	<input checked="" type="checkbox"/>	<input type="checkbox"/>	<input checked="" type="checkbox"/>
220 K	<input type="checkbox"/>	<input checked="" type="checkbox"/>	<input checked="" type="checkbox"/>	<input type="checkbox"/>	<input type="checkbox"/>
230 K	<input type="checkbox"/>	<input checked="" type="checkbox"/>	<input type="checkbox"/>	<input checked="" type="checkbox"/>	<input checked="" type="checkbox"/>
240 K	<input type="checkbox"/>	<input checked="" type="checkbox"/>	<input type="checkbox"/>	<input checked="" type="checkbox"/>	<input type="checkbox"/>
250 K	<input type="checkbox"/>	<input checked="" type="checkbox"/>	<input type="checkbox"/>	<input type="checkbox"/>	<input checked="" type="checkbox"/>
260 K	<input type="checkbox"/>	<input checked="" type="checkbox"/>	<input type="checkbox"/>	<input type="checkbox"/>	<input type="checkbox"/>
270 K	<input type="checkbox"/>	<input checked="" type="checkbox"/>	<input checked="" type="checkbox"/>	<input checked="" type="checkbox"/>	<input checked="" type="checkbox"/>
280 K	<input type="checkbox"/>	<input type="checkbox"/>	<input checked="" type="checkbox"/>	<input checked="" type="checkbox"/>	<input type="checkbox"/>
290 K	<input type="checkbox"/>	<input type="checkbox"/>	<input checked="" type="checkbox"/>	<input type="checkbox"/>	<input checked="" type="checkbox"/>
300 K	<input type="checkbox"/>	<input type="checkbox"/>	<input checked="" type="checkbox"/>	<input type="checkbox"/>	<input type="checkbox"/>
350 K	<input type="checkbox"/>	<input type="checkbox"/>	<input type="checkbox"/>	<input checked="" type="checkbox"/>	<input checked="" type="checkbox"/>
400 K	<input type="checkbox"/>	<input type="checkbox"/>	<input type="checkbox"/>	<input checked="" type="checkbox"/>	<input type="checkbox"/>
450 K	<input type="checkbox"/>	<input type="checkbox"/>	<input type="checkbox"/>	<input type="checkbox"/>	<input checked="" type="checkbox"/>
460 K	<input type="checkbox"/>	<input type="checkbox"/>	<input type="checkbox"/>	<input type="checkbox"/>	<input type="checkbox"/>

Connection	Selection of Output Switch 2		Switching on the manual fine adjustment Switch 1	
	6	7	man adj.	8
0 ... 10 V	<input checked="" type="checkbox"/>	<input type="checkbox"/>	off	<input type="checkbox"/>
0 ... 20 mA	<input type="checkbox"/>	<input checked="" type="checkbox"/>	on	<input type="checkbox"/>
4 ... 20 mA	<input type="checkbox"/>	<input checked="" type="checkbox"/>	on	<input checked="" type="checkbox"/>

Time of step response	Selection of step set time Switch 2	
	8	
slow	<input checked="" type="checkbox"/>	<input type="checkbox"/>
fast	<input type="checkbox"/>	<input checked="" type="checkbox"/>

■ = on
□ = off

RTD, 4-wire converter

- 4-wire connection
- Adjustable temperature range from -200 °C...+800 °C
- Power supply can be cross-connected using plug-in jumpers
- No galvanic isolation between input and output circuits

PT100 / 4 0 (4)...20 mA

PT100 / 4 0...10 V

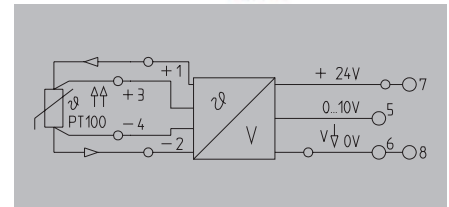
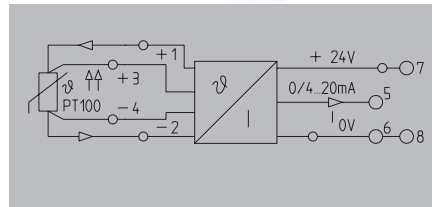
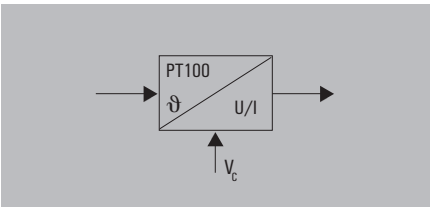

Technical data

Input	
Sensor	PT100 / 2-/3-/4-wire
Sensor supply	1.45 mA
Output	
Output voltage / Output current	/ 0...20 mA, 4...20 mA
Load impedance, voltage/current	/ ≤ 500 Ω
General data	
Configuration	DIP switch, Potentiometer
Supply voltage / Current consumption	24 V DC ± 20 % /
Ambient temperature	0 °C...+55 °C
Accuracy	100K ≤ MB < 600K: 0.1 %; MB ≥ 600K: 0.2 %; of measuring range
Approvals	CE; CSA; cULus; GOSTME25
Standards	DIN EN 50178, DIN EN 61000-4-2
EMC standards	EN 55011, EN 61000-6
Dimensions	
Clamping range (nominal / min. / max.)	mm ²
Depth x width x height	mm
Note	

Tension-clamp connection		Tension-clamp connection	
0.5 / 2.5	0.5 / 2.5	0.5 / 2.5	0.5 / 2.5
112.4 / 12.5 /	112.4 / 12.5 /	112.4 / 12.5 /	112.4 / 12.5 /
Type		Qty.	
WTZ4 PT100/4 C 0/4-20mA		1	
WTZ4 PT100/4 C 0/4-20mA variabel		1	
Order No.		Order No.	
8432280000		8432289999	

Tension-clamp connection		Tension-clamp connection	
0.5 / 2.5	0.5 / 2.5	0.5 / 2.5	0.5 / 2.5
112.4 / 12.5 /	112.4 / 12.5 /	112.4 / 12.5 /	112.4 / 12.5 /
Type		Qty.	
WTZ4 PT100/4 V 0-10V		1	
WTZ4 PT100/4 V 0-10V variabel		1	
Order No.		Order No.	
8432250000		8432259999	

Ordering data

Adjustable from -200...+800°C	Tension-clamp connection
Special adjustment	Tension-clamp connection

Type	Qty.	Order No.
WTZ4 PT100/4 C 0/4-20mA	1	8432280000
WTZ4 PT100/4 C 0/4-20mA variabel	1	8432289999

Type	Qty.	Order No.
WTZ4 PT100/4 V 0-10V	1	8432250000
WTZ4 PT100/4 V 0-10V variabel	1	8432259999

Note

Cross-connectors for power supplies and markers - refer to WAVESERIES accessories

Specify temperature range for special calibrations.

Applications

Example for Zero and Span

Temperature adjustment

T _{min}	-10 °C
Span	75...110 °C
Span	95 °C
Adjustment of Span	+25 %

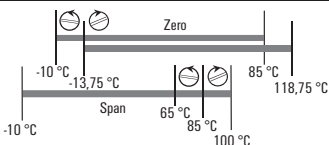

Temperature coefficient

Measurement range ≥ 200 K	≤ 200 ppm/°C (typ. 80 ppm/°C)
100 K ≤ Measurement range < 200 K	≤ 205 ppm/°C (typ. 90 ppm/°C)
40 K ≤ Measurement range < 100 K	≤ 450 ppm/°C (typ. 180 ppm/°C)

Aids

- Voltage supply 24 V DC, 50 mA
- Simulator for PT 100 or precision-resistance-decade
- Ampere-/voltmeter which can be calibrated to an accuracy of > 0,1% of the end value.

Switch position/setting options

T_{min}	1	2	3	Span	4	5	6
0 °C	■	■	■	40...50 °C	■	■	■
-10 °C	■	■	□	50...75 °C	■	■	□
-20 °C	■	□	■	75...110 °C	■	□	■
-40 °C	■	□	□	110...165 °C	■	□	□
-60 °C	□	■	■	165...245 °C	□	■	■
-80 °C	□	■	□	245...360 °C	□	■	□
-100 °C	□	□	■	360...540 °C	□	□	■
-200 °C	□	□	□	540...800 °C	□	□	□
Output ¹⁾				PT 100			
Range	7			8 9 10			
0...20 mA	□			2-Wire ■ ■ ■			
4...20 mA	■			3-Wire ■ ■ ■			
				4-Wire □ ■ □			

¹⁾ only modules with current output

■ = on
□ = off

RTD, 3-wire converter

- 3-wire connection
- Adjustable temperature range from -200 °C...+800 °C
- Power supply can be cross-connected using plug-in jumpers
- No galvanic isolation between input and output circuits

PT100 / 3 0...10 V



PT100 / 3 0 (4)...20 mA

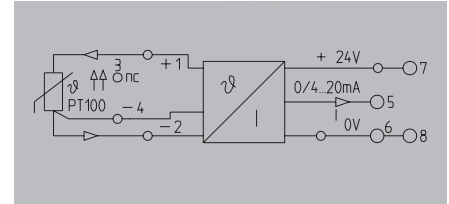
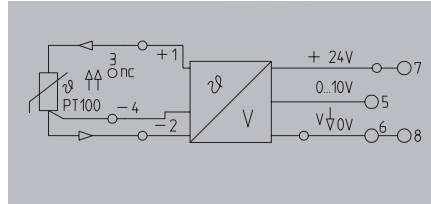
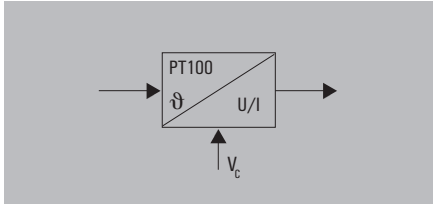

Technical data

Input	
Sensor	PT100
Sensor supply	1.45 mA
Output	
Output voltage / Output current	0...10 V /
Load impedance, voltage/current	≥ 1 kΩ /
General data	
Configuration	DIP switch, Potentiometer
Supply voltage / Current consumption	24 V DC ± 20 % /
Ambient temperature	0 °C...+55 °C
Accuracy	± 0.5 % of measuring range
Approvals	CE; CSA; cULus; GOSTME25
Standards	DIN EN 50178, DIN EN 61000-4-2
EMC standards	EN 55011, EN 61000-6
Dimensions	
Clamping range (nominal / min. / max.)	mm ²
Depth x width x height	mm
Note	

Tension-clamp connection	
Type	WTZ4 PT100/3 V 0-10V
Qty.	1
Order No.	8432130000

Tension-clamp connection	
Type	WTZ4 PT100/3 C 0/4-20mA
Qty.	1
Order No.	8432160000
Type	WTZ4 PT100/3 C 0/4-20mA variabel
Qty.	1
Order No.	8432169999

Ordering data

Adjustable from -200...+800°C	Tension-clamp connection
-------------------------------	--------------------------

Note

Specify temperature range for special calibrations.

Cross-connectors for power supplies and markers - refer to WAVESERIES accessories

Applications

Example for Zero and Span

Temperature adjustment	
T _{min}	-10 °C
Span	75...110 °C
Span	95 °C
Adjustment of Span	+25 %

Temperature coefficient

Measurement range ≥ 200 K	≤ 200 ppm/°C (typ. 80 ppm/°C)
100 K ≤ Measurement range < 200 K	≤ 205 ppm/°C (typ. 90 ppm/°C)
40 K ≤ Measurement range < 100 K	≤ 450 ppm/°C (typ. 180 ppm/°C)

Aids

- Voltage supply 24 V DC, 50 mA
- Simulator for PT 100 or precision-resistance-decade
- Ampere-/voltmeter which can be calibrated to an accuracy of > 0,1% of the end value.

Switch position/setting options

Tmin	1	2	3	Span	4	5	6
0 °C	■	■	■	40...50 °C	■	■	■
-10 °C	■	■	□	50...75 °C	■	■	□
-20 °C	■	□	■	75...110 °C	■	□	■
-40 °C	■	□	□	110...165 °C	■	□	■
-60 °C	□	■	■	165...245 °C	□	■	■
-80 °C	□	■	□	245...360 °C	□	■	□
-100 °C	□	□	■	360...540 °C	□	□	■
-200 °C	□	□	□	540...800 °C	□	□	□

Output ¹⁾	7	PT 100	8	9	10
Range	0...20 mA	2-Wire	■	■	■
	4...20 mA	3-Wire	■	■	■
		4-Wire	□	■	□

¹⁾ only modules with current output

■ = on
□ = off

RTD, 2-wire converter

- 2-wire connection
- Adjustable temperature range from -200 °C...+800 °C
- Power supply can be cross-connected using plug-in jumpers
- No galvanic isolation between input and output circuits

PT100 / 2 0...10 V



PT100/2 0 (4)...20 mA

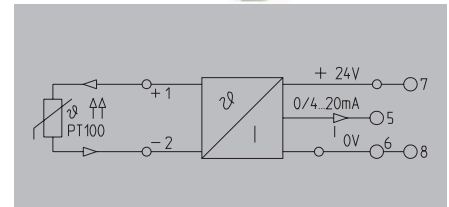
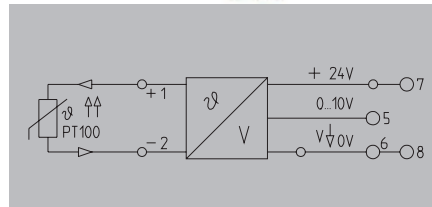
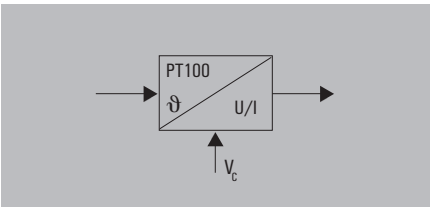

Technical data

Input	
Sensor	PT100/2-wire
Sensor supply	1.45 mA
Output	
Output voltage / Output current	0...10 V /
Load impedance, voltage/current	≥ 1 kΩ /
General data	
Configuration	DIP switch, Potentiometer
Supply voltage / Current consumption	24 V DC ± 20 % / < 38 mA @ I _{OUT} = 20 mA
Ambient temperature	0 °C...+55 °C
Accuracy	± 0.5 % of measuring range
Approvals	CE, CSA, cULus, GOSTME25
Standards	DIN EN 50178, DIN EN 61000-4-2
EMC standards	EN 55011, EN 61000-6
Dimensions	
Clamping range (nominal / min. / max.)	mm ²
Depth x width x height	mm
Note	

Tension-clamp connection		Tension-clamp connection	
1.5 / 0.5 / 2.5	1.5 / 0.5 / 2.5	1.5 / 0.5 / 2.5	1.5 / 0.5 / 2.5
112.4 / 12.5 /	112.4 / 12.5 /	112.4 / 12.5 /	112.4 / 12.5 /
Type		Qty.	
WTZ4 PT100/2 V 0-10V		1	
WTZ4 PT100/2 V 0-10V variabel		1	
Order No.		Order No.	
8432190000		8432199999	

Tension-clamp connection		Tension-clamp connection	
1.5 / 0.5 / 2.5	1.5 / 0.5 / 2.5	1.5 / 0.5 / 2.5	1.5 / 0.5 / 2.5
112.4 / 12.5 /	112.4 / 12.5 /	112.4 / 12.5 /	112.4 / 12.5 /
Type		Qty.	
WTZ4 PT100/2 C 0/4-20mA		1	
WTZ4 PT100/2 C 0/4-20mA variabel		1	
Order No.		Order No.	
8432220000		8432229999	

Ordering data

Adjustable from -200...+800°C	Tension-clamp connection
Special adjustment	Tension-clamp connection

Type		Qty.		Order No.	
WTZ4 PT100/2 V 0-10V		1		8432190000	
WTZ4 PT100/2 V 0-10V variabel		1		8432199999	

Type		Qty.		Order No.	
WTZ4 PT100/2 C 0/4-20mA		1		8432220000	
WTZ4 PT100/2 C 0/4-20mA variabel		1		8432229999	

Note

Specify temperature range for special calibrations.

Cross-connectors for power supplies and markers - refer to WAVESERIES accessories

Applications

Example for Zero and Span

Temperature adjustment

T _{min}	-10 °C
Span	75...110 °C
Span	95 °C
Adjustment of Span	+25 %

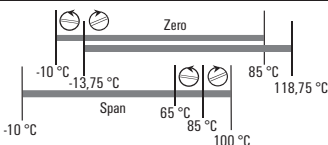

Temperature coefficient

Measurement range ≥ 200 K	≤ 200 ppm/°C (typ. 80 ppm/°C)
100 K ≤ Measurement range < 200 K	≤ 205 ppm/°C (typ. 90 ppm/°C)
40 K ≤ Measurement range < 100 K	≤ 450 ppm/°C (typ. 180 ppm/°C)

Aids

- Voltage supply 24 V DC, 50 mA
- Simulator for PT 100 or precision-resistance-decade
- Ampere-/voltmeter which can be calibrated to an accuracy of > 0,1% of the end value.

Switch position/setting options

Tmin	1	2	3	Span	4	5	6
0 °C	■	■	■	40...50 °C	■	■	■
-10 °C	■	■	□	50...75 °C	■	■	□
-20 °C	■	□	■	75...110 °C	■	□	■
-40 °C	■	□	□	110...165 °C	■	□	■
-60 °C	□	■	■	165...245 °C	□	■	■
-80 °C	□	■	□	245...360 °C	□	■	■
-100 °C	□	□	■	360...540 °C	□	□	■
-200 °C	□	□	□	540...800 °C	□	□	□
Output ¹⁾				PT 100			
Range	7			8 9 10			
0...20 mA	□			2-Wire ■ ■ ■			
4...20 mA	■			3-Wire □ ■ ■			
				4-Wire □ □ ■			

¹⁾ only modules with current output

■ = on
□ = off

WAVESERIES - Temperature measuring transducer

Thermal converter type:

K,J,T,E,N,R,S,B

- 3-way isolation
- Internal cold-junction compensation
- Power supply can be cross-connected using plug-in jumpers
- Suitable for insulated and uninsulated thermocouples
- WAVETOOL software helps with configuration, download at www.weidmuller.com

PRO Thermo

UL Class I, Div. 2

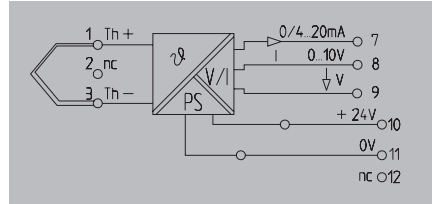
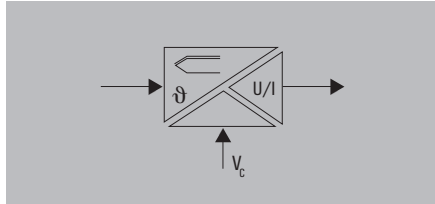

Technical data

Input	
Sensor	
Temperature input range	
Output	
Output voltage / Output current	
Load impedance, voltage/current	
Offset current / Offset voltage	
Line resistance in measuring circuit	
Sensor error detection	
Fine adjustment	
Status indicator	
General data	
Configuration	
Supply voltage	
Power consumption	
Step response time	
Current-carrying capacity of cross-connect.	
Ambient temperature	
Storage temperature	
Default setting	
Approvals	
Insulation coordination	
Standards	
EMC standards	
Rated voltage	
Impulse withstand voltage	
Insulation voltage	
Overvoltage category	
Pollution degree	
Clearance & creepage distances	
Dimensions	
Clamping range (nominal / min. / max.)	mm ²
Depth x width x height	mm
Note	

Ordering data

	Screw connection
	Tension-clamp connection
Note	

Accessories

Note	
------	--

Thermo element (IEC 584) type: K,J,T,E,N,R,S,B	
Temperature input range	
Output voltage / Output current	
Load impedance, voltage/current	
Offset current / Offset voltage	
Line resistance in measuring circuit	
Sensor error detection	
Fine adjustment	
Status indicator	
General data	
Configuration	
Supply voltage	
Power consumption	
Step response time	
Current-carrying capacity of cross-connect.	
Ambient temperature	
Storage temperature	
Default setting	
Approvals	
Insulation coordination	
Standards	
EMC standards	
Rated voltage	
Impulse withstand voltage	
Insulation voltage	
Overvoltage category	
Pollution degree	
Clearance & creepage distances	
Dimensions	
Clamping range (nominal / min. / max.)	
Depth x width x height	
Note	

Screw connection	Tension-clamp connection
2.5 / 0.5 / 2.5	1.5 / 0.5 / 2.5
112.4 / 17.5	112.4 / 17.5

Type	Qty.	Order No.
WAS5 PRO Thermo	1	8560720000
WAZ5 PRO Thermo	1	8560730000

Note	
Cross-connector for power supplies and markers - refer to Accessories	

Typ	Select of thermocoupler SW1			Selection of minimum temperature SW1				
	1	2	3	9 min	1	2	3	4
K	■	■	■	0 °C	■	■	■	■
J	□	■	■	-10 °C	■	■	■	□
T	■	□	■	-20 °C	■	■	□	■
E	□	□	■	-30 °C	■	■	□	□
N	■	■	□	-40 °C	■	□	■	■
R	□	□	□	-50 °C	■	□	□	□
S	■	□	□	-100 °C	■	□	□	■
B	□	□	□	-150 °C	■	□	□	□
				-200 °C	□	■	■	■
				+50 °C	□	■	■	□
				+100 °C	□	■	■	■
				+150 °C	□	■	□	□
				+200 °C	□	□	■	□
				+250 °C	□	□	■	□
				+500 °C	□	□	□	■
				Special range	□	□	□	□

Span	Selection of temperature span SW2					Selection of output Switch 2	
	1	2	3	4	5	Output	Switch 2
100 °C	■	■	■	■	■	0 ... 10 V	□
150 °C	■	■	■	■	□	0 ... 20 mA	□
200 °C	■	■	■	■	□	4 ... 20 mA	■
250 °C	■	■	■	□	□		
300 °C	■	■	■	□	□		
350 °C	■	■	□	□	□		
400 °C	■	■	□	□	□		
450 °C	■	■	□	□	□		
500 °C	■	□	□	□	□		
550 °C	■	□	□	□	□		
600 °C	■	□	□	□	□		
650 °C	■	□	□	□	□		
700 °C	■	□	□	□	□		
750 °C	■	□	□	□	□		
800 °C	■	□	□	□	□		
850 °C	■	□	□	□	□		
900 °C	□	■	■	■	■		
950 °C	□	■	■	■	□		
1000 °C	□	■	■	■	■		
1050 °C	□	■	■	■	□		
1100 °C	□	■	■	■	□		
1150 °C	□	■	■	■	□		
1200 °C	□	■	□	□	□		
1250 °C	□	■	□	□	□		
1300 °C	□	□	■	■	■		
1350 °C	□	□	■	■	□		
1400 °C	□	□	■	■	■		
1450 °C	□	□	■	■	□		
1500 °C	□	□	□	■	■		
1600 °C	□	□	□	■	□		
1700 °C	□	□	□	■	■		
1800 °C	□	□	□	□	■		

Accuracy

K	-200 °C ... -150 °C	± (5K + 0.1 % of set range)
	-150 °C ... 1200 °C	± (3K + 0.1 % of set range)
	1200 °C ... 1372 °C	± (4K + 0.1 % of set range)
J	-200 °C ... -150 °C	± (4K + 0.1 % of set range)
	-150 °C ... 1200 °C	± (3K + 0.1 % of set range)
T	-200 °C ... -150 °C	± (5K + 0.1 % of set range)
	-150 °C ... 400 °C	± (3K + 0.1 % of set range)
E	-200 °C ... -150 °C	± (4K + 0.1 % of set range)
	-150 °C ... 1000 °C	± (3K + 0.1 % of set range)
N	-200 °C ... -150 °C	± (6K + 0.1 % of set range)
	-150 °C ... 1300 °C	± (3K + 0.1 % of set range)
R	-50 °C ... 200 °C	± (10K + 0.1 % of set range)
	200 °C ... 1760 °C	± (6K + 0.1 % of set range)
S	-50 °C ... 200 °C	± (10K + 0.1 % of set range)
	200 °C ... 1760 °C	± (6K + 0.1 % of set range)
B	50 °C ... 250 °C	± (25K + 0.1 % of set range)
	250 °C ... 500 °C	± (10K + 0.1 % of set range)
	500 °C ... 1820 °C	± (6K + 0.1 % of set range)

Thermal converter type:

K, J, T, E, N, R, S, B

- No calibration necessary
- Internal cold-junction compensation
- Output signal selectable
- Power supply can be cross-connected using plug-in jumpers
- Suitable for insulated thermocouples
- No galvanic isolation between input and output circuits

Thermo Select

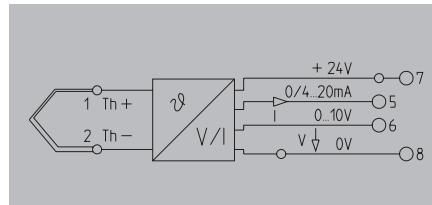
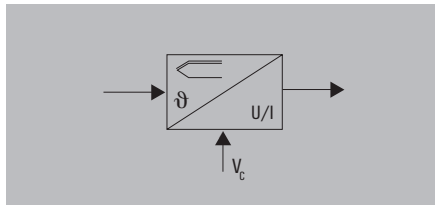

Technical data

Input	
Sensor	
Temperature input range	
Output	
Output voltage / Output current	
Load impedance, voltage/current	
Temperature coefficient	
Step response time	
Sensor error detection	
General data	
Configuration	
Supply voltage	
Current consumption	
Current-carrying capacity of cross-connect.	
Ambient temperature	
Storage temperature	
Approvals	
Insulation coordination	
Standards	
EMC standards	

Thermo element (IEC 584) type: K,J,T,E,N,R,S,B	
-200...+1820 °C	
0...10 V / 0...20 mA, 4...20 mA	
≥ 1 kΩ / ≤ 500 Ω	
± (200 ppm from the span + 0.075 K)/K	
without filter: 1.1 s; with filter: 6 s	
LED flashing (output value: > 20 mA, >10 V)	
DIP switch	
24 V DC ± 20 %	
< 38 mA @ I _{OUT} = 20 mA	
≤ 2 A	
0 °C...+55 °C	
-20 °C...+85 °C	
CE, CSA; cULus; GOSTME25	
DIN EN 50178, DIN EN 61000-4-2	
EN 55011, EN 61000-6	

Dimensions	
Clamping range (nominal / min. / max.)	mm ²
Depth x width x height	mm
Note	

Screw connection	Tension-clamp connection
2.5 / 0.5 / 2.5	1.5 / 0.5 / 2.5
112.4 / 12.5	112.4 / 12.5

Ordering data

	Screw connection
	Tension-clamp connection

Type	Qty.	Order No.
WTS4 THERMO	1	8432300000
WTZ4 THERMO	1	8432310000

Note

Accessories

Note

Cross-connector for power supplies and markers - refer to Accessories

Switch position/setting options

Type	SW 1			SW 2					
	1	2	3	Span	1	2	3	4	5
K	■	■	■	100 °C	■	■	■	■	■
J	□	■	■	150 °C	■	■	■	■	□
T	■	□	■	200 °C	■	■	■	□	■
E	□	□	■	250 °C	■	■	■	□	□
N	■	■	□	300 °C	■	■	■	■	■
R	□	■	□	350 °C	■	■	■	□	□
S	■	□	□	400 °C	■	■	■	□	■
B	□	□	□	450 °C	■	■	■	□	□
				500 °C	■	■	■	■	■
				550 °C	■	□	■	■	□
				600 °C	■	□	■	■	□
				650 °C	■	□	■	■	□
				700 °C	■	□	■	■	■
				750 °C	■	□	■	■	□
				800 °C	■	□	■	■	□
				850 °C	■	□	■	■	□
				900 °C	□	■	■	■	■
				950 °C	□	■	■	■	■
				1000 °C	□	■	■	■	■
				1050 °C	□	■	■	■	□
				1100 °C	□	■	■	■	■
				1150 °C	□	■	■	■	□
				1200 °C	□	■	■	■	□
				1250 °C	□	■	■	■	□
				1300 °C	□	■	■	■	□
				1350 °C	□	■	■	■	□
				1400 °C	□	■	■	■	■
				1450 °C	□	■	■	■	□
				1500 °C	□	■	■	■	■
				1600 °C	□	■	■	■	□
				1700 °C	□	■	■	■	■
				1800 °C	□	■	■	■	□
SW 1		SW 2							
Tmin	4	5	6	7					
0 °C	■	■	■	■					
-10 °C	■	■	■	□					
-20 °C	■	■	□	■					
-30 °C	■	■	□	■					
-40 °C	■	■	■	■					
-50 °C	■	□	■	□					
-100 °C	■	□	■	□					
-150 °C	■	□	□	■					
-200 °C	□	■	■	■					
+50 °C	□	■	■	□					
+100 °C	□	■	■	□					
+150 °C	□	■	□	□					
+200 °C	□	■	■	■					
+250 °C	□	■	■	□					
+500 °C	□	□	■	■					
SW 2		SW 1							
Output	6	7							
0 ... 10 V	■	□							
0 ... 20 mA	□	□							
4 ... 20 mA	□	■							
Filter		8							
off			□						
on			■						

■ = off
□ = on

Accuracy

K	-200 °C ... -150 °C	± (5K + 0,1 % of set range)
	-150 °C ... 1200 °C	± (3K + 0,1 % of set range)
	1200 °C ... 1372 °C	± (4K + 0,1 % of set range)
J	-200 °C ... -150 °C	± (4K + 0,1 % of set range)
	-150 °C ... 1200 °C	± (3K + 0,1 % of set range)
T	-200 °C ... -150 °C	± (5K + 0,1 % of set range)
	-150 °C ... 400 °C	± (3K + 0,1 % of set range)
E	-200 °C ... -150 °C	± (4K + 0,1 % of set range)
	-150 °C ... 1000 °C	± (3K + 0,1 % of set range)
N	-200 °C ... -150 °C	± (6K + 0,1 % of set range)
	-150 °C ... 1300 °C	± (3K + 0,1 % of set range)
R	-50 °C ... 200 °C	± (10K + 0,1 % of set range)
	200 °C ... 1760 °C	± (6K + 0,1 % of set range)
S	-50 °C ... 200 °C	± (10K + 0,1 % of set range)
	200 °C ... 1760 °C	± (6K + 0,1 % of set range)
B	50 °C ... 250 °C	± (25K + 0,1 % of set range)
	250 °C ... 500 °C	± (10K + 0,1 % of set range)
	500 °C ... 1820 °C	± (6K + 0,1 % of set range)

WAVEANALOG PRO Frequency

WAVEANALOG PRO Frequency delivers settings help, for any input and output values.

The input range is set using the DIP switches (a frequency generator is not required)

There are 2 different methods:

D

1. Lower measuring frequency = 0 Hz

- Choose operating mode “= ... fmax” S2.3 = 0 and S2.4 = 0
- Set the upper measuring frequency using DIP switches S1 and S2.1, S2.2 (see table)
- That’s all!

2. Lower measuring frequency ≠ 0 Hz

- First the lower measuring frequency must be saved. Select mode “save fmin”. S2.3 = 1 and S2.4 = 0. Set the frequency using DIP switches S1 and S2.1, S2.2 (see table) To save the frequency, briefly connect the module to the power supply.
- Select mode “fmin ... fmax” S2.3 = 0 and S2.4 = 1
- Set the upper measuring frequency using DIP switches S1 and S2.1, S2.2 (see table).
- That’s all!

Adjusting input range using frequency device to be measured:

- Select the switch setting for saving the frequency: S2.1 = 0, S2.2 = 1, S2.3 = 1 and S2.4 = 1
- Apply min. frequency to the module
- Connect the module to the power supply
- The LED lights up when the input frequency is being measured. If the LED goes off, the frequency has been saved and the module can be disconnected from the power supply again.
- Repeat with max. frequency: S2.1 = 1, S2.2 = 0, S2.3 = 1 and S2.4 = 1
- Select special range: S2.1 = 1, S2.2 = 1, S2.3 = 1 and S2.4 = 1

Connection configuration for the sensors

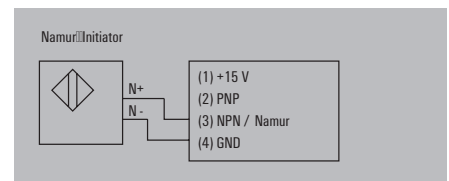
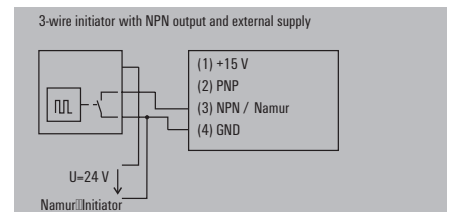
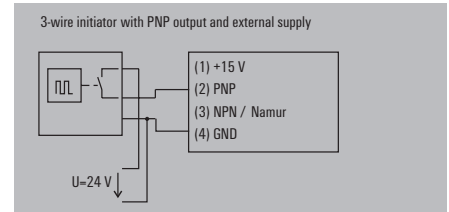
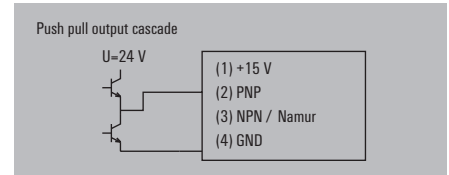
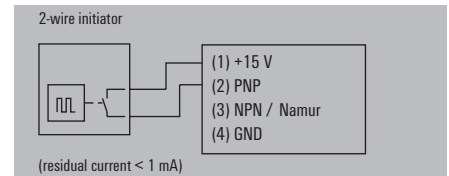
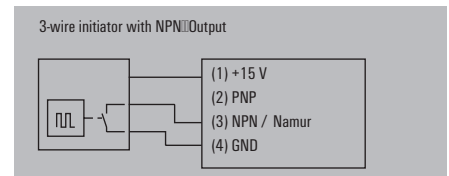
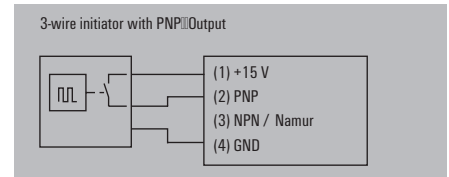

f/DC isolator/converter

- 3-way isolation
- Max. input frequency: 100 kHz
- Input and output ranges can be adjusted via DIP switches
- No calibration necessary
- Supplies the NAMUR sensor
- Programmable custom range
- Can be adjusted and set using the WAVETOOL software, download from www.weidmueller.com

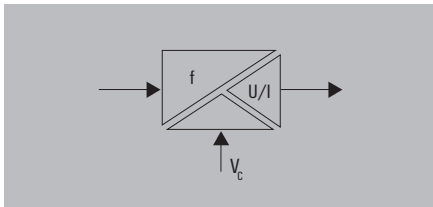

PRO Frequency

UL Class I, Div. 2

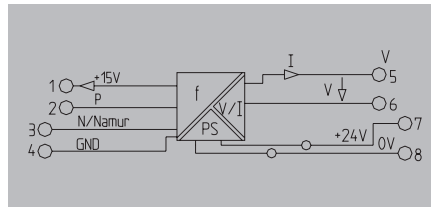

Technical data

Input	
Sensor	
Rated input level	
Output	
Output voltage / Output current	
Load impedance, voltage/current	
Offset current / Offset voltage	
Status indicator	
General data	
Configuration	
Supply voltage	
Power consumption	
Accuracy	
Temperature coefficient	
Step response time	
Ambient temperature	
Approvals	
Insulation coordination	
Standards	
EMC standards	
Rated voltage	
Impulse withstand voltage	
Insulation voltage	
Overvoltage category	
Pollution degree	
Clearance & creepage distances	

2; 3-wire PNP/NPN, Namur initiator, push-pull step, Frequency
Threshold/hysteresis: Namur: approx. 1.7 mA/approx. 0.2 mA; NPN: approx. 6.5 V/approx. 0.2 V; PNP: approx. 6,7 V/approx. 0.5 V
0...10 V / 0...20 mA, 4...20 mA
≥ 1 kΩ / ≤ 600 Ω
max. 100 μA / max. 0.05 V
Green LED
DIP switch
24 V DC ± 20 %
Max. 1.6 W at I _{OUT} = 20 mA
< 0.2% of output range
Max. 200 ppm/K of output range
360 ms + 2 times the period time of input frequency
0 °C...+55 °C
CE; cULusEX
DIN EN 50178, DIN EN 61000-4-2
EN 55011, EN 61000-6, EN 61326
300 V
6 kV
4 kV _{eff} / 5 s
III
2
≥ 5.5 mm

Dimensions	
Clamping range (nominal / min. / max.)	mm ²
Depth x width x height	mm
Note	

Screw connection	Tension-clamp connection
2.5 / 0.5 / 2.5	1.5 / 0.5 / 2.5
112.4 / 12.5	112.4 / 12.5

Ordering data

Screw connection
Tension-clamp connection

Type	Qty.	Order No.
WAS4 PRO Freq	1	8581180000
WAZ4 PRO Freq	1	8581190000

Note

Accessories

Note

Cross-connector for power supplies and markers - refer to Accessories

Selecting the operating mode			
Operating mode	Switch 2		
	3	4	
0 ... fmax	<input type="checkbox"/>	<input type="checkbox"/>	
fmin ... fmax	<input type="checkbox"/>	<input checked="" type="checkbox"/>	
saving of fmin	<input checked="" type="checkbox"/>	<input type="checkbox"/>	

f = (A+B) x C

Selecting the frequency				
A	Switch 1			
	1	2	3	4
0	<input type="checkbox"/>	<input type="checkbox"/>	<input type="checkbox"/>	<input type="checkbox"/>
1	<input type="checkbox"/>	<input type="checkbox"/>	<input type="checkbox"/>	<input checked="" type="checkbox"/>
2	<input type="checkbox"/>	<input type="checkbox"/>	<input checked="" type="checkbox"/>	<input type="checkbox"/>
3	<input type="checkbox"/>	<input type="checkbox"/>	<input type="checkbox"/>	<input checked="" type="checkbox"/>
4	<input type="checkbox"/>	<input checked="" type="checkbox"/>	<input type="checkbox"/>	<input type="checkbox"/>
5	<input type="checkbox"/>	<input type="checkbox"/>	<input checked="" type="checkbox"/>	<input type="checkbox"/>
6	<input type="checkbox"/>	<input checked="" type="checkbox"/>	<input type="checkbox"/>	<input type="checkbox"/>
7	<input type="checkbox"/>	<input checked="" type="checkbox"/>	<input checked="" type="checkbox"/>	<input type="checkbox"/>
8	<input checked="" type="checkbox"/>	<input type="checkbox"/>	<input type="checkbox"/>	<input type="checkbox"/>
9	<input checked="" type="checkbox"/>	<input type="checkbox"/>	<input type="checkbox"/>	<input checked="" type="checkbox"/>
10	<input checked="" type="checkbox"/>	<input type="checkbox"/>	<input type="checkbox"/>	<input type="checkbox"/>
11	<input checked="" type="checkbox"/>	<input type="checkbox"/>	<input checked="" type="checkbox"/>	<input type="checkbox"/>
12	<input checked="" type="checkbox"/>	<input checked="" type="checkbox"/>	<input type="checkbox"/>	<input type="checkbox"/>
13	<input checked="" type="checkbox"/>	<input checked="" type="checkbox"/>	<input checked="" type="checkbox"/>	<input type="checkbox"/>
14	<input checked="" type="checkbox"/>	<input checked="" type="checkbox"/>	<input type="checkbox"/>	<input type="checkbox"/>
15	<input checked="" type="checkbox"/>	<input checked="" type="checkbox"/>	<input checked="" type="checkbox"/>	<input checked="" type="checkbox"/>

Selecting the frequency				
B	Switch 1			
	5	6	7	8
0	<input type="checkbox"/>	<input type="checkbox"/>	<input type="checkbox"/>	<input type="checkbox"/>
0.1	<input type="checkbox"/>	<input type="checkbox"/>	<input type="checkbox"/>	<input checked="" type="checkbox"/>
0.2	<input type="checkbox"/>	<input type="checkbox"/>	<input checked="" type="checkbox"/>	<input type="checkbox"/>
0.3	<input type="checkbox"/>	<input type="checkbox"/>	<input type="checkbox"/>	<input checked="" type="checkbox"/>
0.4	<input type="checkbox"/>	<input checked="" type="checkbox"/>	<input type="checkbox"/>	<input type="checkbox"/>
0.5	<input type="checkbox"/>	<input checked="" type="checkbox"/>	<input checked="" type="checkbox"/>	<input type="checkbox"/>
0.6	<input type="checkbox"/>	<input checked="" type="checkbox"/>	<input type="checkbox"/>	<input type="checkbox"/>
0.7	<input type="checkbox"/>	<input checked="" type="checkbox"/>	<input checked="" type="checkbox"/>	<input type="checkbox"/>
0.8	<input type="checkbox"/>	<input type="checkbox"/>	<input type="checkbox"/>	<input type="checkbox"/>
0.9	<input checked="" type="checkbox"/>	<input type="checkbox"/>	<input type="checkbox"/>	<input checked="" type="checkbox"/>

Selecting the frequency		
C	Switch 2	
	1	2
x1	<input type="checkbox"/>	<input type="checkbox"/>
x10	<input type="checkbox"/>	<input checked="" type="checkbox"/>
x100	<input checked="" type="checkbox"/>	<input type="checkbox"/>
x1000	<input checked="" type="checkbox"/>	<input checked="" type="checkbox"/>

Selecting the output				
Output	Switch 2			
	5	6	7	8
0...10 V	<input checked="" type="checkbox"/>	<input type="checkbox"/>	<input checked="" type="checkbox"/>	<input checked="" type="checkbox"/>
0...20 mA	<input type="checkbox"/>	<input type="checkbox"/>	<input type="checkbox"/>	<input type="checkbox"/>
4...20 mA	<input type="checkbox"/>	<input checked="" type="checkbox"/>	<input type="checkbox"/>	<input type="checkbox"/>
0...5 V	<input checked="" type="checkbox"/>	<input checked="" type="checkbox"/>	<input checked="" type="checkbox"/>	<input checked="" type="checkbox"/>

Special range (frequency generator is required)				
Function	Switch 2			
	1	2	3	4
save min. frequency	<input type="checkbox"/>	<input checked="" type="checkbox"/>	<input checked="" type="checkbox"/>	<input checked="" type="checkbox"/>
save max. frequency	<input checked="" type="checkbox"/>	<input type="checkbox"/>	<input checked="" type="checkbox"/>	<input checked="" type="checkbox"/>
select special range	<input checked="" type="checkbox"/>	<input checked="" type="checkbox"/>	<input checked="" type="checkbox"/>	<input checked="" type="checkbox"/>

■ = on
□ = off

Application

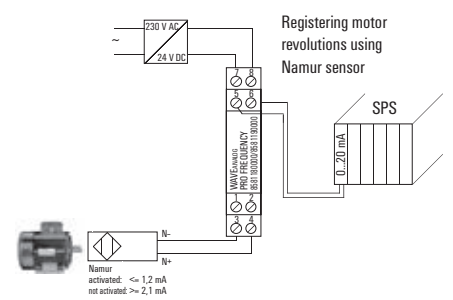

Analogue output

- Monitors AC/DC currents
- Input and output are electrically isolated
- Input and output ranges adjustable via DIP switch

5/10 A AC/DC

20/25/30 A AC/DC

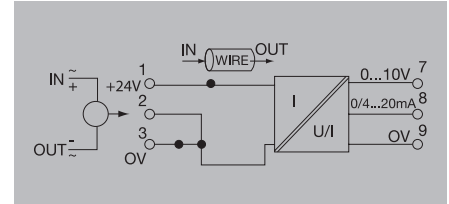
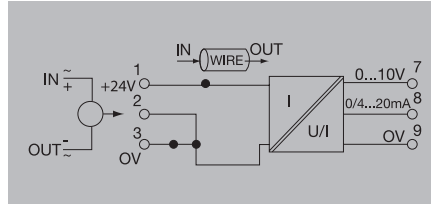
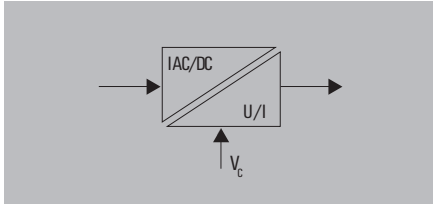

D

Technical data

Input	
Input current	0...5 A AC/DC / 0...10 A AC/DC
Input frequency	0...2 kHz (True RMS)
Max. current	Depends on wire cross-section
Voltage of measuring circuit	10-400 VAC, > 400 VAC depending on wire insulation
Sensor	Hall sensor (internal)
Diameter of cable feed-through	8 mm
Output	
Output current / Output voltage	0(4)...20 mA / 0...10 V
Offset current	max. 150 µA
Output signal limit	Approx. 13 V or 24 mA
Load impedance, voltage/current	≥ 1 kΩ / ≤ 600 Ω
Step response time	typ. 700 ms, Frequency-independent
Accuracy	1 % FSR
Temperature coefficient	≤ 650 ppm/K
Status indicator	LED ON: OK; FLASHING: signal out of range; LED OFF: Error
General data	
Configuration	DIP switch
Supply voltage	24 V DC ± 10 %
Current consumption	50 mA @ I _{out} = 20 mA
Current-carrying capacity of cross-connect.	≤ 2 A
Ambient temperature / Storage temperature	0 °C...+50 °C / -20 °C...+70 °C
Default setting	0...5 A, 4...20 mA
Approvals	CE; cULus
Insulation coordination	
Standards	DIN EN 50178 (secure separation)
EMC standards	EN 55011, EN 61000-6
Rated voltage	300 V
Impulse withstand voltage	6 kV
Pollution degree	2
Overvoltage category	III
Clearance & creepage distances	≥ 5.5 mm
Insulation voltage	4 kV _{eff} / 5 s
Dimensions	
Clamping range (nominal / min. / max.)	mm ²
Depth x width x height	mm
Note	

Screw connection		Tension-clamp connection			
2.5 / 0.5 / 2.5	112.4 / 22.5	1.5 / 0.5 / 2.5	112.4 / 22.5		
Type		Qty.		Order No.	
WAS2 CMA 5/10A uc		1		8526610000	
WAZ2 CMA 5/10A uc		1		8526620000	

Screw connection		Tension-clamp connection			
2.5 / 0.5 / 2.5	112.4 / 22.5	1.5 / 0.5 / 2.5	112.4 / 22.5		
Type		Qty.		Order No.	
WAS2 CMA 20/25/30A uc		1		8545830000	
WAZ2 CMA 20/25/30A uc		1		8545840000	

Ordering data

Screw connection	
Tension-clamp connection	

Note

Accessories

Note	
------	--

Screw connection	
Tension-clamp connection	

Note

Note	Cross-connectors for power supplies and markers - refer to Accessories
------	--

Screw connection	
Tension-clamp connection	

Note

Note	Cross-connectors for power supplies and markers - refer to Accessories
------	--

Analogue output

- Monitors AC/DC currents
- Input and output are electrically isolated
- Input and output ranges adjustable via DIP switch

40/50/60 A AC/DC

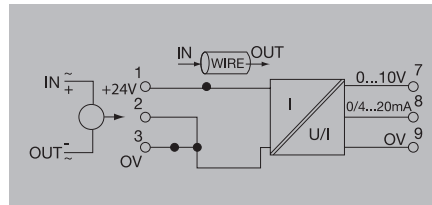
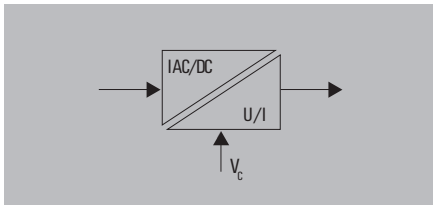

Technical data

Input	
Input current	
Input frequency	
Max. current	
Voltage of measuring circuit	
Sensor	
Diameter of cable feed-through	
Output	
Output current / Output voltage	
Offset current	
Output signal limit	
Load impedance, voltage/current	
Step response time	
Accuracy	
Temperature coefficient	
Status indicator	
General data	
Configuration	
Supply voltage	
Current consumption	
Current-carrying capacity of cross-connect.	
Ambient temperature / Storage temperature	
Default setting	
Approvals	
Insulation coordination	
Standards	
EMC standards	
Rated voltage	
Impulse withstand voltage	
Pollution degree	
Overvoltage category	
Clearance & creepage distances	
Insulation voltage	
Dimensions	
Clamping range (nominal / min. / max.)	mm ²
Depth x width x height	mm
Note	

0...40 A AC/DC / 0...50 A AC/DC / 0...60 A AC/DC			
0...2 kHz (True RMS)			
Depends on wire cross-section			
400 VAC, > 400 VAC depending on wire insulation			
Hall sensor (internal)			
8 mm			
0(4)...20 mA / 0...10 V			
max. 150 µA			
Approx. 13 V or 24 mA			
≥ 1 kΩ / ≤ 600 Ω			
typ. 700 ms			
1 % FSR			
≤ 650 ppm/K			
LED ON: OK; FLASHING: signal out of range; LED OFF: Error			
DIP switch			
24 V DC ± 10 %			
50 mA @ I _{OUT} = 20 mA			
≤ 2 A			
0 °C...+50 °C / -20 °C...+70 °C			
0...50 A, 4...20 mA			
CE; cULus			
DIN EN 50178 (secure separation)			
EN 55011, EN 61000-6			
300 V			
6 kV			
2			
III			
≥ 5.5 mm			
4 kV _{eff} / 5 s			
Screw connection		Tension-clamp connection	
2.5 / 0.5 / 2.5		1.5 / 0.5 / 2.5	
112.4 / 22.5		112.4 / 22.5	
Type	Qty.	Order No.	
WAS2 CMA 40/50/60A uc	1	8513330000	
WAZ2 CMA 40/50/60A uc	1	8526590000	

Ordering data

Screw connection
Tension-clamp connection

Note

Accessories

Cross-connectors for power supplies and markers – refer to Accessories
--

Analogue output

- Monitors AC currents
- Input and output are electrically isolated
- Input and output ranges adjustable via DIP switch

1/5/10 A AC



1/5/10 A AC 4...20 mA

Loop-powered

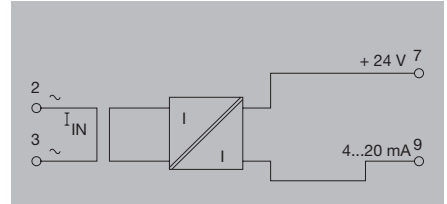
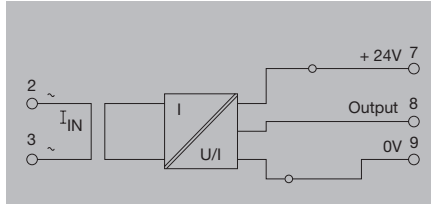
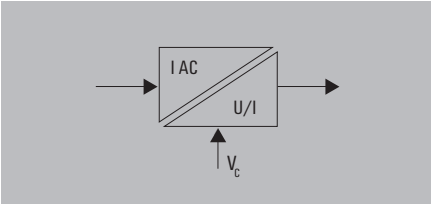

Technical data

Input	
Input current	0...1 A AC/ 0...5 A AC/ 0...10 A AC
Input frequency	50...60 Hz
Max. current	100 A for 1s
Voltage of measuring circuit	250 V AC
Sensor	Transforming (internally)
Output	
Output current / Output voltage	0(4)...20 mA / 0...10 V
Offset current	max. 100 µA
Output signal limit	Approx. 13 V or 24 mA
Load impedance, voltage/current	≥ 1 kΩ / ≤ 600 Ω
Step response time	typ. 700 ms
Accuracy	0.5 % FSR
Temperature coefficient	≤ 200 ppm/K
Status indicator	LED ON: OK; FLASHING: signal out of range; LED OFF: Error
General data	
Configuration	DIP switch
Supply voltage	24 V DC ± 10 %
Current consumption	40 mA @ I _{OUT} = 20 mA
Current-carrying capacity of cross-connect.	≤ 2 A
Ambient temperature / Storage temperature	0 °C...+50 °C / -20 °C...+70 °C
Default setting	0...5 A AC, 4...20 mA
Approvals	CE; cULus
Insulation coordination	
Standards	DIN EN 50178 (secure separation)
EMC standards	EN 55011, EN 61000-6
Rated voltage	300 V
Impulse withstand voltage	6 kV
Pollution degree	2
Overvoltage category	III
Clearance & creepage distances	≥ 5.5 mm
Insulation voltage	4 kV _{eff} / 5 s

Screw connection		Tension-clamp connection	
2.5 / 0.5 / 2.5	1.5 / 0.5 / 2.5	92.4 / 22.5	92.4 / 22.5

Screw connection		Tension-clamp connection	
2.5 / 0.5 / 2.5	1.5 / 0.5 / 2.5	112.4 / 22.5	112.4 / 22.5

Dimensions	
Clamping range (nominal / min. / max.)	mm ²
Depth x width x height	mm
Note	

Ordering data

Screw connection	
Tension-clamp connection	

Type	Qty.	Order No.
WAS1 CMA 1/5/10A ac	1	852340000
WAZ1 CMA 1/5/10A ac	1	852341000

Type	Qty.	Order No.
WAS1 CMA LP 1/5/10A ac	1	852865000
WAZ1 CMA LP 1/5/10A ac	1	852866000

Note

Accessories

Note

Note

Cross-connectors for power supplies and markers - refer to Accessories

Note

Cross-connectors for power supplies and markers - refer to Accessories

Analogue output

- Monitors AC currents
- Input and output are electrically isolated
- Input and output ranges adjustable via DIP switch
- No calibration required
- ATEX II 3 G nL IIC T4
- UL Class I, Div.2

1/5/10 A AC 4...20 mA

Loop-powered

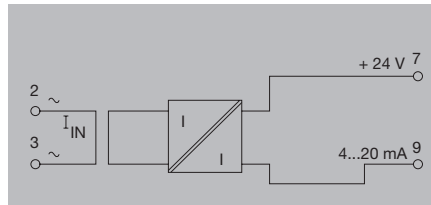
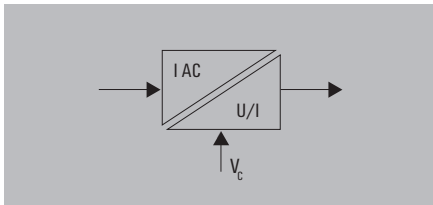

Technical data

Input

- Input current
- Input frequency
- Max. current
- Voltage of measuring circuit
- Sensor

0...1 A AC/ 0...5 A AC/ 0...10 A AC
50...60 Hz
100 A for 1s
250 V AC
Transforming (internally)

Output

- Output current / Output voltage
- Offset current
- Output signal limit
- Load impedance, voltage/current
- Step response time
- Accuracy
- Temperature coefficient
- Status indicator

4...20 mA (current loop) /
max. 100 µA
Approx. 24 mA
/ ≤ 600 Ω
typ. 700 ms
0.5 % FSR
≤ 200 ppm/K
LED ON: OK; FLASHING: signal out of range;
LED OFF: Error

General data

- Configuration
- Supply voltage
- Current consumption
- Current-carrying capacity of cross-connect.
- Ambient temperature / Storage temperature
- Default setting
- Approvals

DIP switch
13...30 V DC, via output current loop
0 °C...+50 °C / -20 °C...+70 °C
0...5 A AC, 4...20 mA
CE; cULusEX; DEMKOATEX; GOSTME25

Insulation coordination

- Standards
- EMC standards
- Rated voltage
- Impulse withstand voltage
- Pollution degree
- Overvoltage category
- Clearance & creepage distances
- Insulation voltage

DIN EN 50178 (secure separation)
EN 55011, EN 61000-6
300 V
6 kV
2
III
≥ 5.5 mm
4 kV _{eff} / 5 s

Dimensions

Clamping range (nominal / min. / max.)	mm ²
Depth x width x height	mm

Screw connection

2.5 / 0.5 / 2.5
112.4 / 22.5

Note

Ordering data

Screw connection

Type	Qty.	Order No.
WAS1 CMA LP 1/5/10A EX	1	8975590000

Note

Accessories

Note

Cross-connectors for power supplies and markers - refer to Accessories

WAVESERIES - Voltage measuring transducer

Analogue output

- 3-way isolation
- Max. measuring voltage 450 V AC_{eff}
- Output range selected via DIP switch
- No calibration necessary

VMA V AC

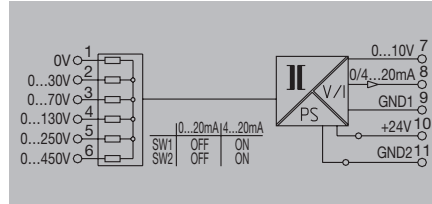
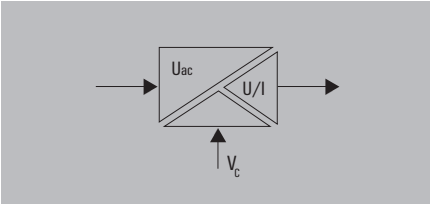

D

Technical data

Input	
Input voltage	0...30 / 0...70 / 0...130 / 0...250 / 0...450 V AC
Input frequency	40...400 Hz sinus
Max. voltage	45 / 100 / 180 / 270 / 475 V AC (briefly)
Output	
Output voltage / Output current	0...10 V / 0(4)...20 mA
Offset voltage / Offset current	max. 0.02 V / max. 40 µA
Load impedance, voltage/current	≥ 1 kΩ / ≤ 600 Ω
Accuracy	1,3 % (40...60 Hz) typ. 1 %; 2 % (70...400 Hz) typ. 1,5 %
Temperature coefficient	≤ 250 ppm/K
Step response time	< 300 ms
Status indicator	Green LED
General data	
Configuration	DIP switch
Supply voltage	24 V DC ± 25 %
Current consumption	40...30...24 mA @ I _{out} = 20 mA
Current-carrying capacity of cross-connect.	≤ 2 A
Default setting	0...10 V / 0...20 mA
Ambient temperature / Storage temperature	0 °C...+50 °C / -20 °C...+70 °C
Approvals	CE; cULus
Insulation coordination	
Standards	DIN EN 50178
EMC standards	EN 61000-2-6, EN 61000-6, EN 61326
Rated voltage	supply/output: 300 V; input/output, supply/output: 600 V
Impulse withstand voltage	Supply/output: 4 kV; input/output, supply/input: 6 kV
Insulation voltage	4 kV _{eff} / 5 s
Overtoltage category	III
Pollution degree	2
Clearance & creepage distances	Supply/output: 3 mm; input/output, supply/output: 5.5 mm

Application

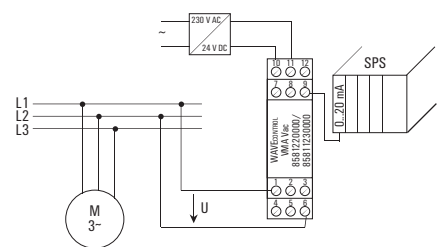

Dimensions	
Clamping range (nominal / min. / max.)	mm ²
Depth x width x height	mm
Note	

Screw connection	Tension-clamp connection
2.5 / 0.5 / 2.5	1.5 / 0.5 / 2.5
112.4 / 22.5	112.4 / 22.5

Ordering data

Screw connection
Tension-clamp connection

Type	Qty.	Order No.
WAS2 VMA V ac	1	8581220000
WAZ2 VMA V ac	1	8581230000

Note

Accessories

Note

Note
Cross-connector for power supplies and markers - refer to Accessories

Isolating converters for serial interfaces

Isolating converters for serial interfaces RS232/ RS485/422 or TTY

Serial interface are used for exchanging data between data processing systems, controllers and peripherals. The WDS2 interface isolating converter is particularly well suited for harsh conditions located near to the process. Versions are available for a variety of industrial applications:

- RS232/RS422 or RS485
- RS232/TTY

The thin (22.5 mm wide) rail-mounted modules come with a 9-pole SUB-D connector for the RS232 connection and a shield connection for the RS485/422 or TTY signal line. In order to ensure high transmission security, the serial interface isolating converters are equipped with high-quality 4-kV 3-way electrical isolation.

- **Easy to service:** the electronic components can be removed from the housing/base without using any tools. The terminating resistor can be selected with DIP switch.
- **High data transmission speeds** up to 115 kBit/s and freely adjustable
- **Secure connection:** 9-pole Sub-D connector for the RS232 interface.
For the serial RS485/422 and TTY connection, the user can connect the shield using the LLBU or the EMC Set (1067470000).



RS232/RS485/422

- 3-way isolation
- RS232 connection via SUB-D 9
- RS485/422, shield connection via KLBU
- Switchable DTE or DCE assignment
- Bi-directional communication

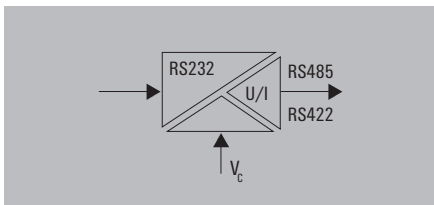

RS232/RS485/422

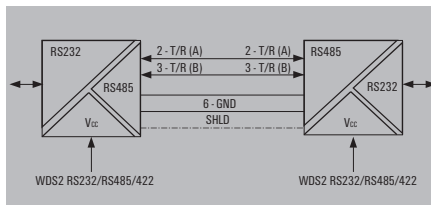

Technical data

RS232	
Connection type / Input current	
Assignment	
RS485/422	
Terminating resistors	
Type of connection	
Bit distortion	
Bit delay	
Control of data direction	
Shield connection	
Status indicator	
Transmission rate	
Transmission channels	
Transmission distance	
General data	
Configuration	
Supply voltage	
Power consumption	
Ambient temperature	
Approvals	
Insulation coordination	
Standards	
EMC standards	
Rated voltage	
Impulse withstand voltage	
Pollution degree	
Overvoltage category	
Clearance & creepage distances	
Insulation voltage	

SUB-D9 (male plug) /
DTE/DCE switchable with DIP switch
Pull-down/pull-up via DIP switch
Screw connection
< 5 %
≤ 3 µs
Automatic or via RS232 RTS/CTS
KLBU 4-6/Z1
LED green: supply voltage, TxD, RxD
2.4, 4.8, 9.6, 19.2, 57.6, 115.2 kBaud, 8 bit or 8 bit + parity bit
Half-duplex (RS485 2-wire)
Full-duplex (RS485 4-wire and RS422)
Max. 1200 m twisted pair
DIP switch
24 V DC ± 20 %
ca. 1.5 W
0 °C...+55 °C
CE; cULus; GL; GOSTME25
DIN EN 50178, DIN EN 61000-4-2
EN 55011, EN 61000-6-2, EN 61000-6-4
between adjacent electric circuits: 300 V
between electric circuits and PE: 150 V
4 kV
2
III
Between neighbouring circuits: 3 mm
Between the circuits and PE: 1.5 mm
2 kV DC / 1 min.

Dimensions	
Clamping range (nominal / min. / max.)	mm ²
Depth x width x height	mm
Note	

Screw connection	
2.5 / 0.5 / 2.5	
/ 22.5 / 112.4	
Note	

Ordering data

Screw connection

Type	Qty.	Order No.
WDS2 RS232/RS485/422	1	8615700000

Note

Accessories

Note

Cross-connector for power supplies and markers - refer to Accessories

Isolating converter for serial interfaces

RS232/TTY

- 3-way isolation
- RS232 connection via SUB-D 9
- TTY shield connection via KLBUE retaining clip
- Switchable DTE or DCE assignment
- Bi-directional communication

RS232/TTY

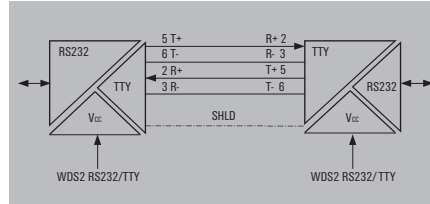
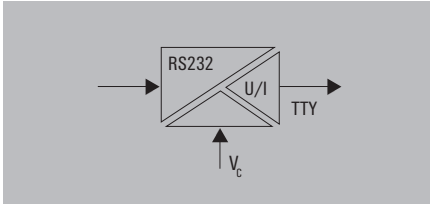

Technical data

RS232

Connection type / Input current

Assignment

TTY

Type of connection

Bit distortion

Bit delay

Load

Shield connection

Status indicator

Transmission rate

Transmission channels

Transmission distance

General data

Configuration

Supply voltage

Power consumption

Ambient temperature

Storage temperature

Approvals

Insulation coordination

Standards

EMC standards

Rated voltage

Impulse withstand voltage

Pollution degree

Overvoltage category

Clearance & creepage distances

Insulation voltage

SUB-D9 (male plug) /

DTE/DCE switchable with DIP switch

Screw connection

< 1.5%

≤ 3 μs

≤ 500 Ω

KLBÜ 4-6/Z1

LED green: supply voltage, TxD, RxD

19.2 kBit/s

Full-duplex

Max. 1000 m twisted pair

DIP switch

24 V DC ± 20 %

ca. 0.8 W

0 °C...+55 °C

-20 °C...+85 °C

CE; cULus; GL; GOSTME25

DIN EN 50178, DIN EN 61000-4-2

EN 55011, EN 61000-6-2, EN 61000-6-4

between adjacent electric circuits: 300 V

between electric circuits and PE: 150 V

4 kV

2

III

Between neighbouring circuits: 3 mm

Between the circuits and PE: 1.5 mm

2 kV DC / 1 min.

Dimensions

Clamping range (nominal / min. / max.) mm²

Depth x width x height mm

Note

Screw connection

2.5 / 0.5 / 2.5

/ 22.5 / 112.4

Ordering data

Screw connection

Type	Qty.	Order No.
WDS2 RS232/TTY	1	8615690000

Note

Accessories

Note

Cross-connector for power supplies and markers - refer to Accessories

Trip amplifier for monitoring AC/DC circuits

Trip amplifier for monitoring AC/DC circuits	Trip amplifier for monitoring AC/DC circuits - Overview	E.2
	WAVESERIES - Limit value monitoring	E.4
	PLUGCONTROL - Current monitoring	E.6
	WAVESERIES - Voltage monitoring	E.8

Trip amplifier for monitoring AC/DC circuits

Monitoring AC/DC currents and voltages within single-phase and three-phase power networks.

Some WAVESERIES products provide the function of monitoring voltage and current. Typical uses include low voltage distribution applications. This includes the monitoring of phase voltages and current while controlling actuators. Another application is in monitoring dropouts of a power supply, or accumulators and feed-in systems within industrial production lines. There are many applications for threshold monitoring (trip amplifier) products in process automation. Typically they are used to generate alarms when „out-of-limits“ signals are detected with fill levels, flow quantities or temperature signals.

The PLUGCONTROL series of current monitoring products monitor DC current up to 10 amps. They can be used in applications to monitor the functioning of valves, servo-controls and DC motors. The pluggable detector uses the same socket (base) as Weidmüller PLUGSERIES relays and optos socket base so it uses the same quick-and-easy to use pluggable ZQV cross-connections for saving wiring time. A lever is provided to quickly release or instal the detector.

Features

WAVECONTROL:

- Threshold monitoring of analogue standard signals
- Measuring AC currents ranging from 1 to 30 A
- Monitoring DC and AC voltages up to 400 V
- Fully adjustable switching thresholds
- Relay outputs for monitoring threshold
- Versatile pluggable connection method – screw or spring

PLUGCONTROL:

- Monitoring for DC currents ranging from 0.5 to 10 A
- Very small, pluggable monitoring unit
- Reed relay contact for monitoring and measuring current
- Install on standard base
- Quick initial commissioning – with replaceable electronics
- Minimal wiring effort – with pluggable ZQV 2,5N cross-connector

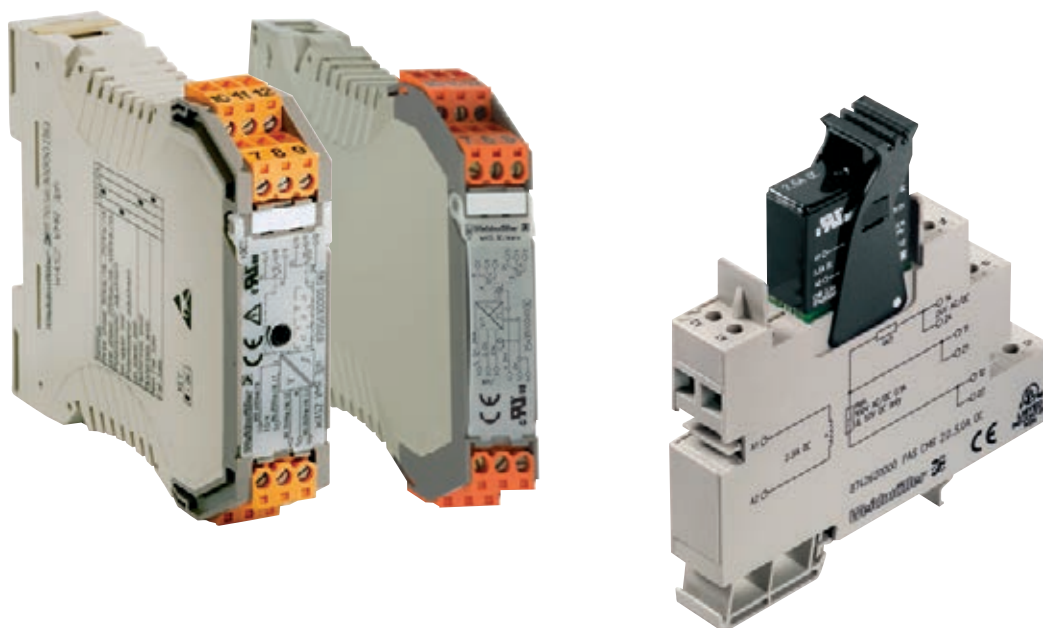



**Threshold monitoring of analogue
standard signals**



Current monitoring



Voltage monitoring

Relay output

- 3-way isolation
- Low trip / high trip
- FAILSAFE / NON-FAILSAFE
- 2 relay outputs 250 V AC / 3 A

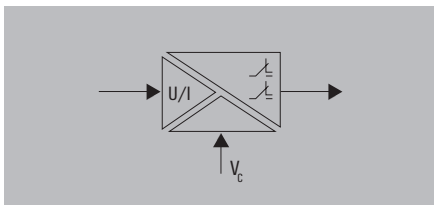

DC/Alarm

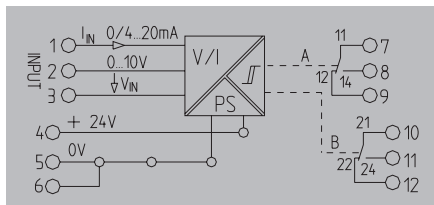

Technical data

Input	
Input voltage	0...10 V
Input current	0(4)...20 mA
Input resistance, voltage/current	≥ 100 kΩ / ≤ 110 Ω
Output	
Contact assembly	2 CO contacts
Contact material	AgNi 90/10
Switching thresholds	1...90 % (independently for channel 1 and channel 2)
Hysteresis	1...10 % (independent for channel 1 and channel 2)
Max. switching voltage, AC	250 V
Continuous current	3 A
Function	Open-circuit/closed-circuit principle
Temperature coefficient	≤ 500 ppm/K
Status indicator	LED green ON: OK, LED red ON: alarm (per channel)
General data	
Configuration	DIP switch, Potentiometer
Supply voltage	24 V DC ± 25 %
Power consumption	Typically 1 W both relays picked up
Current-carrying capacity of cross-connect.	≤ 2 A
Ambient temperature	0 °C...+55 °C
Default setting	Channel A/B: low trip and FAILSAFE
Approvals	CE; cULus
Insulation coordination	
Standards	DIN EN 50178
EMC standards	EN 61000-4-2, -3, -4, -5, -6
Rated voltage	300 V
Impulse withstand voltage	4 kV
Pollution degree	2
Overvoltage category	III
Clearance & creepage distances	≥ 3 mm
Insulation voltage	2 kV _{eff} / 5 s

Dimensions	
Clamping range (nominal / min. / max.)	mm ²
Length x width x height	mm
Note	

Ordering data

	Screw connection
	Tension-clamp connection

Note

Accessories

Note
Cross-connector for power supplies and markers - refer to Accessories

Screw connection		Tension-clamp connection	
2.5 / 0.5 / 2.5		1.5 / 0.5 / 2.5	
92.4 / 17.5		92.4 / 17.5	

Type	Qty.	Order No.
WAS5 DC/Alarm	1	8543820000
WAZ5 DC/Alarm	1	8543880000

Switch position/setting options

function	SW 1			
	1	2	3	4
Channel A High Trip	■			
Channel A Low Trip	□			
Channel B High Trip		■		
Channel B Low Trip		□		
FAILSAFE, Channel 1 & 2			□	□
NON FAILSAFE, Chan. 1 & 2			■	■

■ = on
□ = off

- NON FAILSAFE:** The relay picks up when the alarm is triggered
- FAILSAFE:** The relay drops out when the alarm is triggered. An alarm is also triggered in the FAILSAFE mode, if for example, the operating voltage to the modules fails
- Low Trip:** Alarm is triggered if the signal is under the threshold.
- High Trip:** Alarm is triggered if the signal is over the threshold.
- Signal threshold:** Adjustments of the signal threshold (1...90%) are made for channel 1 with the potentiometer P1, and separately for channel 2 via potentiometer P2.
- Hysteresis:** Adjustments of the hysteresis (1...10%) are made for channel 1 with the potentiometer P3, and separately for channel 2 via potentiometer P3.

WAVEANALOG DC/Alarm - Alarm indication

Example 1

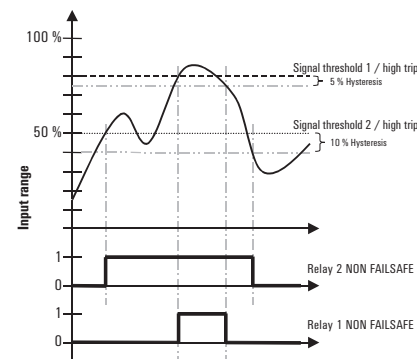

Example 2

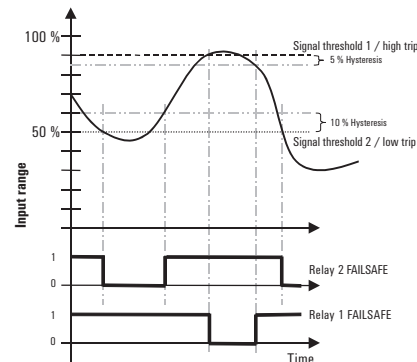

Relay output

- Monitors AC currents
- Current ranges can be adjusted using DIP switches
- Switchable hysteresis
- Open-circuit/closed-circuit principle

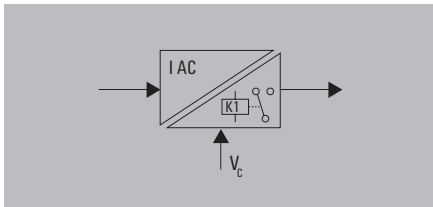

1/5/10 A AC

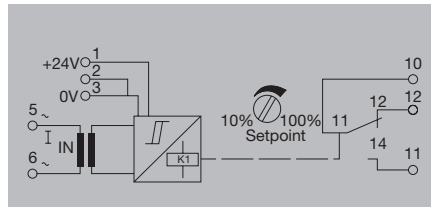

20/40/60 A AC

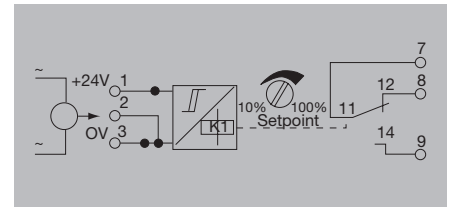

Technical data

Input	
Input current	0...1 A AC/ 0...5 A AC/ 0...10 A AC
Input frequency	50...60 Hz
Max. current	100 A for 1s
Max. voltage	250 V AC
Sensor	Transforming (internally)
Diameter of cable feed-through	4 mm
Output	
Switching thresholds	Adjustable 10...100% with front potentiometer
Contact assembly	1 CO contact
Hysteresis	5% or 10% of threshold value
Switching voltage AC / Switching voltage DC	6 V...250 V / 6 V...60 V
Switching current	7 A
Continuous current	3 A
Step response time	typ. 700 ms
Temperature coefficient	≤ 800 ppm/K
Status indicator	Green LED
General data	
Configuration	DIP switch, Potentiometer
Supply voltage	24 V DC ± 10 %
Ambient temperature	0 °C...+50 °C
Default setting	0...5 A / 10 % hysteresis / open-circuit principle
Approvals	CE; cULus
Insulation coordination	
EMC standards	EN 55011, EN 61000-6
Rated voltage	300 V
Impulse withstand voltage	4 kV
Pollution degree	2
Overvoltage category	III
Clearance & creepage distances	≥ 3 mm
Insulation voltage	4 kV _{eff} / 5 s
Dimensions	
Clamping range (nominal / min. / max.)	mm ²
Length x width x height	mm
Note	

Screw connection		Tension-clamp connection			
2.5 / 0.5 / 2.5	1.5 / 0.5 / 2.5	2.5 / 0.5 / 2.5	1.5 / 0.5 / 2.5		
92.4 / 22.5	92.4 / 22.5	92.4 / 22.5	92.4 / 22.5		
Type		Qty.		Order No.	
WAS2 CMR 1/5/10A ac		1		8516560000	
WAZ2 CMR 1/5/10A ac		1		8516570000	

Screw connection		Tension-clamp connection			
2.5 / 0.5 / 2.5	1.5 / 0.5 / 2.5	2.5 / 0.5 / 2.5	1.5 / 0.5 / 2.5		
92.4 / 22.5	92.4 / 22.5	92.4 / 22.5	92.4 / 22.5		
Type		Qty.		Order No.	
WAS2 CMR 20/40/60A ac		1		8513340000	
WAZ2 CMR 20/40/60A ac		1		8526600000	

Ordering data

	Screw connection
	Tension-clamp connection
Note	
Accessories	
Note	

	Cross-connector for power supplies and markers – refer to Accessories
Note	

	Cross-connector for power supplies and markers – refer to Accessories
Note	

Relay output

- Monitors currents up to 10 A DC
- Used with valves, servo-controls or DC motors
- Pull-up / pull-down resistor 4.7 kΩ

PAS CMR 0.5...2.5 A DC

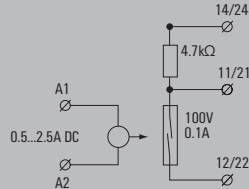

PAS CMR 2.0...5.0 A DC

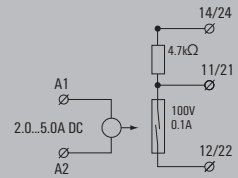

Technical data

Input	
Input current	0.5...2.5 A DC
Max. current	7.5 A for 10 s
Making current threshold	≤ 500 mA
Resistance of sensor circuit	50 Ω
Secure off	≤ 50 mA
Pulse duration	min. 1 ms
Output	
Switching current	100 mA
Switching voltage AC / Switching voltage DC	1 V...100 V / 1 V...100 V
Max. switching frequency	15 Hz
Contact assembly	1 NO contact
Contact material	RH/Rd (Reed contact)*
General data	
Configuration	none
Ambient temperature	0 °C...+55 °C
Humidity	5-95% rel. humidity, T _v = 40°C, no condensation
Approvals	CE; cULus
Insulation coordination	
Standards	DIN EN 50178 (secure separation)
EMC standards	EN 55011, EN 61000-6-1, 2, 3, 4
Rated voltage	300 V
Impulse withstand voltage	6 kV
Insulation voltage	4 kV _{eff} / 1 min.
Overvoltage category	III
Pollution degree	2
Clearance & creepage distances	≥ 5 mm (grout encapsulated)

Input	
Input current	0.5...2.5 A DC
Max. current	7.5 A for 10 s
Making current threshold	≤ 500 mA
Resistance of sensor circuit	50 Ω
Secure off	≤ 50 mA
Pulse duration	min. 1 ms
Output	
Switching current	100 mA
Switching voltage AC / Switching voltage DC	1 V...100 V / 1 V...100 V
Max. switching frequency	15 Hz
Contact assembly	1 NO contact
Contact material	RH/Rd (Reed contact)*
General data	
Configuration	none
Ambient temperature	0 °C...+55 °C
Humidity	5-95% rel. humidity, T _v = 40°C, no condensation
Approvals	CE; cULus
Insulation coordination	
Standards	DIN EN 50178 (secure separation)
EMC standards	EN 55011, EN 61000-6-1, 2, 3, 4
Rated voltage	300 V
Impulse withstand voltage	6 kV
Insulation voltage	4 kV _{eff} / 1 min.
Overvoltage category	III
Pollution degree	2
Clearance & creepage distances	≥ 5 mm (grout encapsulated)

Input	
Input current	2...5.0 A DC
Max. current	15 A for 10 s
Making current threshold	≤ 2 A
Resistance of sensor circuit	50 Ω
Secure off	≤ 300 mA
Pulse duration	min. 1 ms
Output	
Switching current	100 mA
Switching voltage AC / Switching voltage DC	1 V...100 V / 1 V...100 V
Max. switching frequency	15 Hz
Contact assembly	1 NO contact
Contact material	RH/Rd (Reed contact)*
General data	
Configuration	none
Ambient temperature	0 °C...+55 °C
Humidity	5-95% rel. humidity, T _v = 40°C, no condensation
Approvals	CE; cULus
Insulation coordination	
Standards	DIN EN 50178 (secure separation)
EMC standards	EN 55011, EN 61000-6-1, 2, 3, 4
Rated voltage	300 V
Impulse withstand voltage	6 kV
Insulation voltage	4 kV _{eff} / 1 min.
Overvoltage category	III
Pollution degree	2
Clearance & creepage distances	≥ 5 mm (grout encapsulated)

Dimensions	
Clamping range (nominal / min. / max.)	mm ²
Length x width x height	mm
Note	

Screw connection	
Clamping range (nominal / min. / max.)	mm ²
Length x width x height	mm
Note	

Screw connection	
Clamping range (nominal / min. / max.)	mm ²
Length x width x height	mm
Note	

Ordering data

Screw connection

Type	Qty.	Order No.
PAS CMR 0,5...2,5 A DC	10	8742610000

Type	Qty.	Order No.
PAS CMR 2,0...5,0 A DC	10	8742620000

Note

Note

Note

Accessories

Note

Cross-connectors and markers - refer to WAVESERIES Accessories
--

Cross-connectors and markers - refer to WAVESERIES Accessories
--

Relay output

- Monitors currents up to 10 A DC
- Used with valves, servo-controls or DC motors
- Pull-up / pull-down resistor 4.7 kΩ

PAS CMR 4.5...10 A DC

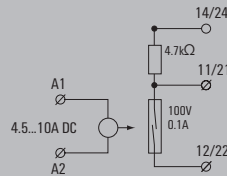

Technical data

Input	
Input current	4.5...10 A DC
Max. current	30 A for 10 s
Making current threshold	≤ 4.5 A
Resistance of sensor circuit	50 Ω
Secure off	≤ 600 mA
Pulse duration	min. 1 ms
Output	
Switching current	100 mA
Switching voltage AC / Switching voltage DC	1 V...100 V / 1 V...100 V
Max. switching frequency	15 Hz
Contact assembly	1 NO contact
Contact material	RH/Rd (Reed contact)*
General data	
Configuration	none
Ambient temperature	0 °C...+55 °C
Humidity	5-95% rel. humidity, T _v = 40°C, no condensation
Approvals	CE, cULus
Insulation coordination	
Standards	DIN EN 50178 (secure separation)
EMC standards	EN 55011, EN 61000-6-1, 2, 3, 4
Rated voltage	300 V
Impulse withstand voltage	6 kV
Insulation voltage	4 kV _{eff} / 1 min.
Overvoltage category	III
Pollution degree	2
Clearance & creepage distances	≥ 5 mm (grout encapsulated)

Dimensions	
Clamping range (nominal / min. / max.)	mm ²
Length x width x height	mm
Note	
Screw connection	
Ordering data	
Screw connection	
Note	
Accessories	
Note	

Dimensions	
Clamping range (nominal / min. / max.)	mm ²
Length x width x height	mm
Note	

Screw connection		
	1.5 / 2.5 / 2.5	
	92 / 15.3 / 95	
* The peak current should be limited to 100 mA when under capacitive loads.		

Ordering data		
	Screw connection	

Type	Qty.	Order No.
PAS CMR 4.5...10 A DC	10	8742630000

Note	
-------------	--

Accessories	
Note	

Note	
Cross-connectors and markers - refer to WAVESERIES Accessories	

Relay output

- 3-way isolation
- Monitoring of single-phase systems up to 260 V AC/DC
- 4 input ranges per DIP switch can be selected
- 1 relay module with CO contact
- Switchable hysteresis
- Switch adjusted via potentiometer
- Reset input

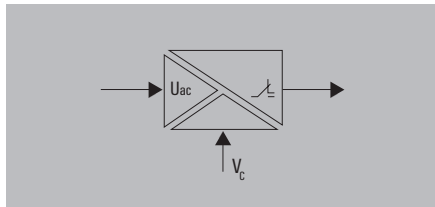

VMR V AC / DC

Single-phase

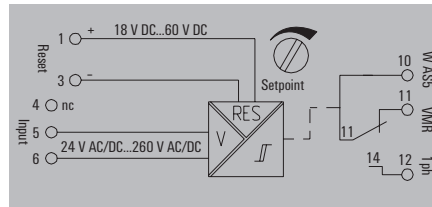

Technical data

Input	
Input voltage	24...70 / 70...140 / 140...210 / 210...260 V AC / DC
Input frequency	50...60 Hz
Max. voltage	260 V AC / DC
Output	
Max. switching voltage, AC	250 V
Switching current	8 A
Continuous current	3 A
Hysteresis	24...70 V AC, small = 5 V / large = 10 V, 70-260 VAC, small = 8 V / large = 16
Temperature coefficient	≤ 250 ppm/K
Step response time	< 300 ms
Repeat accuracy	< 0.3 % of set range
Status indicator	LED green = OK / LED yellow/red = alarm status
General data	
Supply voltage	from the measuring circuit
Reset input voltage, min./max.	18 V DC / 30 V DC
Pulse duration	≤ 700 ms
Configuration	DIP switch, Potentiometer
Default setting	DIP switches: ON = 1,2,5,8 / OFF = 3,4,6,7
Ambient temperature	-10 °C...+55 °C
Storage temperature	-20 °C...+70 °C
Approvals	CE; cULus; GOSTME25
Insulation coordination	
Standards	DIN EN 50178
EMC standards	EN 55011, EN 61000-6, EN 61326
Rated voltage	input/output, input/reset input, reset input/output: 300 V
Impulse withstand voltage	Input/output, input/reset input, reset input/output: 4 kV
Insulation voltage	2 kV _{eff}
Oversvoltage category	III
Pollution degree	2
Clearance & creepage distances	≥ 3 mm

Dimensions	
Clamping range (nominal / min. / max.)	mm ²
Length x width x height	mm
Note	

Ordering data

Screw connection

Note

Accessories

Markers - refer to Accessories.

Screw connection		
2.5 / 0.5 / 2.5		
96.5 / 17.5		
Type		
WAS5 VMR 1ph	Qty. 1	Order No. 8705640000

Table of setting options

Input	1	2	3	4	5	6	7	8
24 V AC/DC...70 V AC/DC	■	□	□	□	□	□	□	□
70 V AC/DC...140 V AC/DC	□	□	□	□	□	■	□	□
140 V AC/DC...210 V AC/DC	□	□	□	□	□	□	■	□
210 V AC/DC...260 V AC/DC	□	□	□	□	□	□	□	■
Trip								
High Trip	■							
Low Trip	□							
Memory								
Memory on	□							
Memory out	■							
Hysteresis								
Hysteresis small	□							
Hysteresis large	■							
Input voltage								
AC voltage								■
DC voltage								□

■ = on
□ = out

Status indicator

- Set value not exceeded.
- Alarm status.
- Alarm status can be reset because set value has been exceeded.

Abb.1: Overvoltage monitoring
Alarm set to "high trip"
(Set permanently to closed-circuit principle.)



Abb.2: Undervoltage monitoring
Alarm set to "low trip"
(Set permanently to closed-circuit principle.)



Relay output

- 2-way isolation
- Monitoring of 1- and 3-phase systems from 80 to 400 V AC/DC
- Adjustable by DIP switches
- Monitoring of low and surge voltages
- Detects loss of phase
- 2 relay modules with CO contact

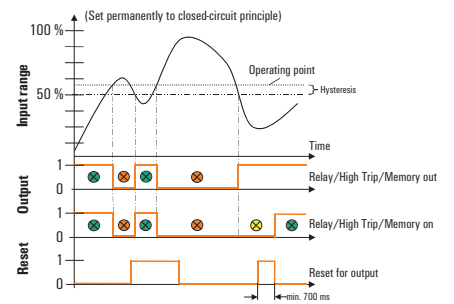
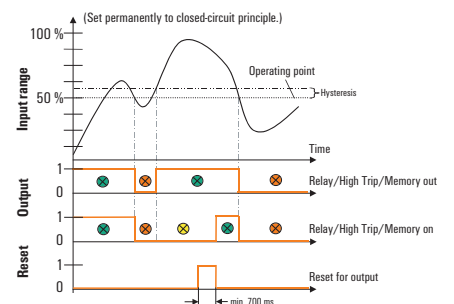
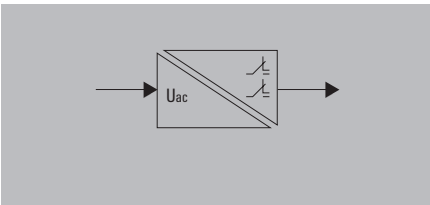

VMR V AC

Three-phase

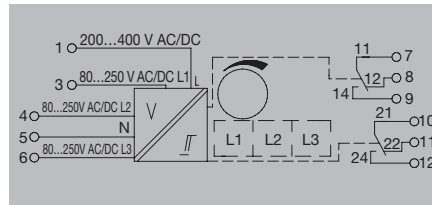

Technical data

Input	
Input voltage	200...400 V AC/DC 1~, 80...250 V AC/DC 3~
Input current	< 10 mA DC; 15 mA AC
Output	
Contact assembly	2 CO contacts
Max. switching voltage, AC	250 V
Continuous current	3 A
Hysteresis	5% of final value
Temperature coefficient	≤ 300 ppm/K
Step response time	< 300 ms
Repeat accuracy	< 0.3 % of set range
Status indicator	Green LED
General data	
Configuration	DIP switch, Potentiometer
Supply voltage	from the measuring circuit
Default setting	DIP switches: ON = 1,2,4 / OFF = 3
Ambient temperature	0 °C...+50 °C
Approvals	CE; cULus; GOSTME25
Insulation coordination	
Standards	DIN EN 50178
EMC standards	EN 55011, EN 61000-6, EN 61326
Rated voltage	600 V
Impulse withstand voltage	6 kV
Insulation voltage	4 kV _{eff} / 1 min.
Overvoltage category	III
Pollution degree	2
Clearance & creepage distances	Output circuit: 1.8 mm; input circuit, output circuit 1/output circuit 2: 3 mm; input/output: 5.5 mm

Dimensions	
Clamping range (nominal / min. / max.)	mm ²
Length x width x height	mm
Note	

Ordering data

	Screw connection
--	------------------

Note	
-------------	--

Accessories

Note	Markers - refer to Accessories.
-------------	---------------------------------

Screw connection		
	2.5 / 0.5 / 2.5	
	96.5 / 22.5	
Type	Qty.	Order No.
WAS2 VMR 3ph	1	8705630000

Table of setting options

Input	1	2	3	4
3 phases 80 V AC/DC...250 V AC/DC		■		
1 phase 200 V AC/DC...400 V AC/DC			□	
Limit value				
Setting to upper switching point		■		
Setting to lower switching point			□	
Hysteresis				
Hysteresis, small			■	
Hysteresis, large				□
Fault tolerance				
Operating current method				■
Closed-circuit current method				□

■ = on
□ = off

Status indicator

Voltage is in set range

Fig. 1: Overvoltage and undervoltage monitoring, example of setting

- 3-phase monitoring
- Setting limit value to upper operating point: 230 V Hysteresis 5% = -12.5 V
- Lower operating point 10% less 230 V - 25 V = 205 V Hysteresis 5% = + 12.5 V
- The device operates with the operating current principle.
- All 3 phases monitored in parallel

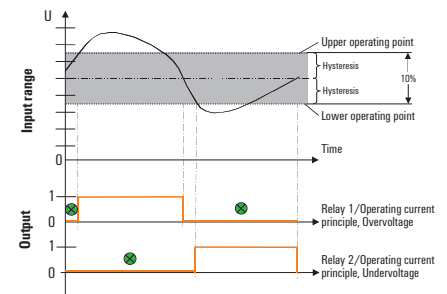
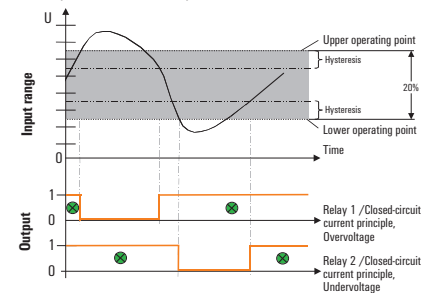

Fig. 2: Overvoltage and undervoltage monitoring, example of setting

- 3-phase monitoring
- Setting limit value to lower operating point: 150 V Hysteresis 5% = +12.5 V
- Upper operating point 20% greater 150 V + 50 V = 200 V Hysteresis 5% = -12.5 V
- The device operates with the closed-circuit current principle.
- All 3 phases monitored in parallel



Indicators and configurable displays

Indicators and configurable displays	Overview	F.2
	Process value displays with LED display	F.4
	Process value displays with LCD display	F.20

Indicators and configurable displays

In industrial and process automation, displays provide a visual rendering of data and an digital presentation of electrical and non-electrical measurements. They provide essential diagnostics, logging and operational guidance when operating machines and facilities.

Displays make dialogue-based operations possible. They show measurements, error messages and also allow processes to be monitored. Displays can also feature digital and analogue outputs, interference-suppression functions, or the ability to calculate certain process variables internally. This turns a simple display into a high-quality process interface capable of independently controlling sub-processes.

F



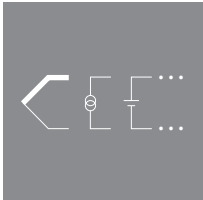

All-purpose

A fitting solution for any application – with a multitude of input ranges, external of input loop-powered supply, and analogue or digital outputs.

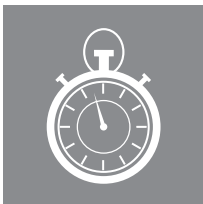

Security

No additional signal isolation is required since there is a high insulation voltage.



Saves time

Easy push-button configuration.



Protection

IP 65 protection allows for use in harsh industrial conditions.



Flow rate or volume monitoring with LED display



Process value indication with LCD display

Counters

PTX800 SERIES

Panel-mounted totaliser/counter/rate monitors

The configurable monitors of the PTX800 SERIES are available in two designs:

- PTX800A for analogue (mA, Volts) inputs
- PTX800D with digital pulse inputs (NAMUR, NPN/PNP sensors, TTL, etc)

The eight-digit LED rate/total display can be changed via a button on the front of the unit. Both versions make use of output relays to close valves when the "total" setpoint is reached. They also have electrically-isolated analogue outputs for re-transmission.

The display can be globally scaled based on the flow quantity per second, minute, hour or day. The flow-quantity counter can be multiplied by factors of 0.001, 0.01, 0.1, 1, 10, 100 or 1000. This allows for best use of the display.

The PTX800A counter processes standardised analogue current and voltage signals. Linearisation and filtering functions are available for processing measurement signals. In addition, the counter has a 24 V DC power supply for loop-powered sensors.

The PTX800D can be connected on the input side to all standard initiators (NPN/PNP/Namur) and with other current/voltage transmitters. The monitor will accept any periodic signal type and can total the input pulses into a "total" display.

It can also calculate the resulting flow rate. External proximity switches can be supplied with 12 V DC directly from the PTX800D.

Typical application of PTX800

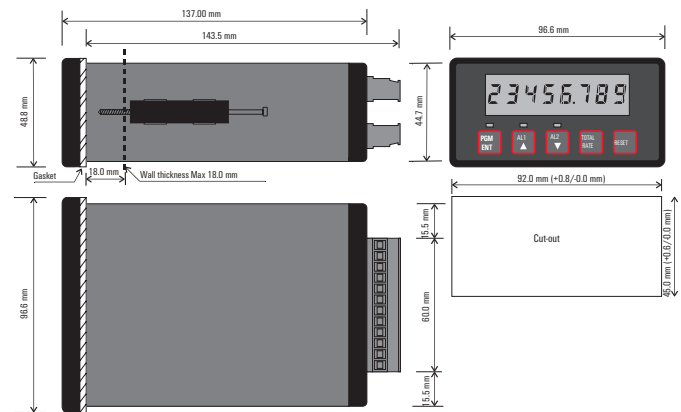
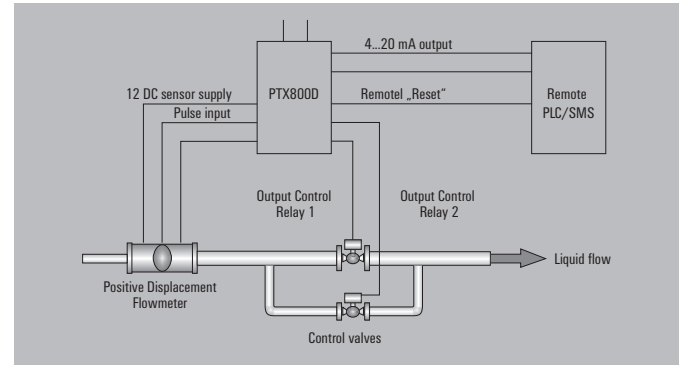

Technical Features

- Display of the flow quantity/rate
- Easily-readable eight-digit LED display
- Up to two outputs for alarm monitoring or control
- Optional analogue output
- Pulse output
- Reset function can be controlled locally or remotely, for fill-quantity monitoring (batching)
- The most recent measured value is stored in case of a power outage
- DC power supply
- LED display for values outside of range
- Complete electrical isolation
- DIN-standard 1/8 front panel with IP 65 protection
- Integrated power supply for initiators
- Changing the device configuration is possible without performing a new calibration
- No internal adjustments needed

Common technical data

Display	
Type	Eight digits, red LED, 7.2 mm
Brightness	Adjustable to 14 levels of brightness
Display value	Percent or real-value displayed
Partial display	Display from 0 to 50,000 (five digits)
Time range, partial display	per sec., min., hour (PT800A also per day)
Total display	Display from 0 to 99,999,999 (8 digits)
Decimal point	Adjustable separately for partial and total display
Status indicator	Alarm 1/2; Status LED
Pulse output	
Type	Transistor output
Display value	One pulse per signal jump of the total display
Pulse duration	32 ms
Cut-off time	Minimum of 32 ms
Analogue output (optional)	
Type	Current or voltage output configurable with jumper
Display range	Dependent on the calibration (within 0 to 22 mA, or 0 to 11 V)
Resolution	1.6 μ A or 0.8 mV / Bit
Load resistance, current	\leq 900 Ω
Load resistance, voltage	\geq 1 k Ω
Residual ripple	< 20 mV _{ss}
Alarm output (optional)	
Type	2 relay contacts (CO)
Switching current	3 A at 240 V AC, 5 A at 24 V DC / 110 V AC (resistive load)
Isolation	1.5 kV between ports
Input reset	
Type	Normally open
Function	Complete reset (display/alarm)
General information	
Supply voltage	24 V DC \pm 10 %
Power consumption	6 W at 24 V DC
Accuracy	< 0.05 %
Linearity	< 0.05 %
Repeat accuracy	\pm 0.02 % of signal range
Humidity	0...90 % (no condensation)
Temperature coefficient	< 0.02 % of signal range
Long-term drift	0.1 % / 10,000 h
Impulse withstand voltage	4 kV (1.2/50 μ s)
Ambient temperature (operational)/storage temperature	0 °C...60 °C / -25 °C...70 °C

Connections

Terminal	Signal	
1	L+	Supply voltage
2	L-	
3	Signal +	Analogue output (optional)
4	Signal -	
5	0 V	Pulse output
6	Pulse	
7	Optional, depending on type	Inputs
8		
9		
10		
11		
12	NO contacts	Alarm channel 1 (optional)
13		
14	NC contact	Alarm channel 2 (optional)
15	NO contacts	
16	Common	
17	NC contact	
18		

Process value displays with LED display

PTX800 Series

Counter and totaliser with additional functionality and limit-value monitoring

- Installation in control panels
- Pluggable connection terminals
- Scalable impulse and frequency counters for digital input signals
- Suitable on input side for all standard initiators

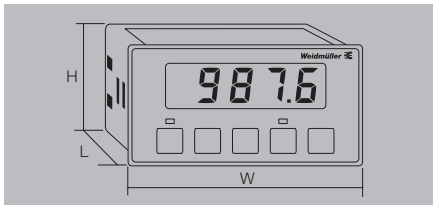

Technical data

Input	
Type	
Input signal	
Sensor supply	
Input voltage	
Total display, display range	
Analogue output (optional)	
Type (analogue output)	
Input reset	
Pulse duration, min.	
Pulse output	
Pulse rate, max.	
General data	
Type	
EMC standards	
Approvals	

PTX800D

Digital pulse input

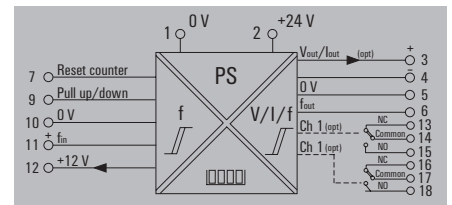

Connections

Terminal	Signal	
7	Reset by connection to class 12	Reset
8	Setup configuration by connection to class 12	Configuration
9	Pull Up / Down	
10	Signal - / 0 V	
11	Signal +	
12	12 V DC	

Dimensions	
Clamping range (nominal / min. / max.)	mm ²
Length x width x height	mm
Note	

Screw connection	
1.5 / 0.5 / 2.5	
137 / 96.6 / 48.8	
Note	

Ordering data

without analogue / alarm output	
with analogue/alarm output	

Type	Qty.	Order No.
PTX800D	1	7940011133
PTX800D RO/AO	1	7940012323

Note

Accessories

Note

PTX800 Series

Counter and totaliser with additional functionality and limit-value monitoring

- Installation in control panels
- Pluggable connection terminals
- Configurable for analogue current and voltage signals
- Linearisation and interference suppression
- Power supply for external sensors

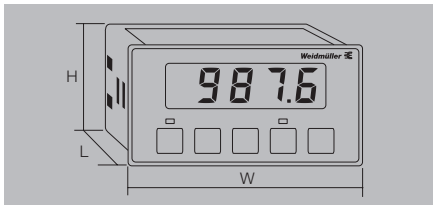

Technical data

Input	
Type	
Input signal	
Sensor supply	
Resolution	
Input resistance	
Total display, display range	
Analogue output (optional)	
Type (analogue output)	
Input reset	
Pulse duration, min.	
Pulse output	
Pulse rate, max.	
General data	
Type	
EMC standards	
Approvals	

PTX800A

Analogue current input / voltage input



Conversion of linear/quadratic input signals into analogue signals
-24...+24 mA / -11...+11 V
24 V DC (up to 25 mA)
0.6 μ, A / 0.3 mV
22 Ω (current input); 1 MΩ (voltage input)
0,001; 0,01; 0,1; 1; 10; 100; 1000
Current of voltage output, configured with jumper
250 ms
15 / s
RO/AO version with 1 analogue output and 2 alarm outputs
DIN EN 61326
CE; cULus

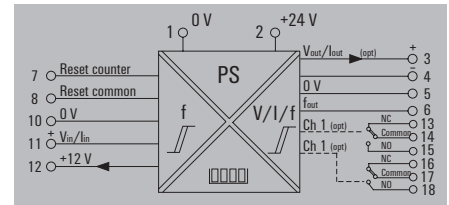

Connections

Terminal	Signal	
7	Reset by connection to class Kl. 8	Reset
8	Common	
9	Setup configuration by connection to class 8	Configuration
10	Signal - /0 V	Inputs
11	Signal +	
12	24 V DC	

Dimensions	
Clamping range (nominal / min. / max.)	mm ²
Length x width x height	mm
Note	

Screw connection	
1.5 / 0.5 / 2.5	
137 / 96.6 / 48.8	

Ordering data

without analogue / alarm output	
with analogue/alarm output	

Type	Qty.	Order No.
PTX800A 4-20mA	1	7940010243
PTX800A 4-20mA/RO/AO	1	7940014374

Note

Accessories

Note

Indicators and configurable displays for analogue signals

PMX420 SERIES

Universal, 4-digit, current/voltage displays

The current/voltage displays of the PMX420 SERIES are available as a pure display unit or optionally with analogue outputs/4 alarm outputs.

The basic model is suitable for displaying a wide range of bipolar mA or voltage signals. Inputs are isolated from the power supply. An integrated power source is available for supplying external sensors and transmitters.

The PMX420 Plus adds four alarm channels (each with its own status indicator and relay contact outputs) and a fully isolated analogue current/voltage output.

Device functions can be configured, specifically for the application, using the integrated keypad on the front panel. There are also several other handy features like maximum and minimum value recall, integrated linearisation, an acoustic alarm, a group alarm function, and the option for manual or automatic alarm reset.

Technical features:

- 4-digit LED display
- Suitable for current and voltage signals
- Bipolar inputs
- Integrated square root function
- Retrieval of min. and max. values
- Integral power supply for active sensors
- DC power supply
- Complete electrical isolation
- Four alarm channels and an analogue current/voltage output (PMX420 Plus)
- LED alarm status indication
- DIN-standard 1/8 front panel with IP 65 protection
- Decimal point can be adjusted to any position
- Configurable via front-panel keypad

Typical application of PMX420 Plus

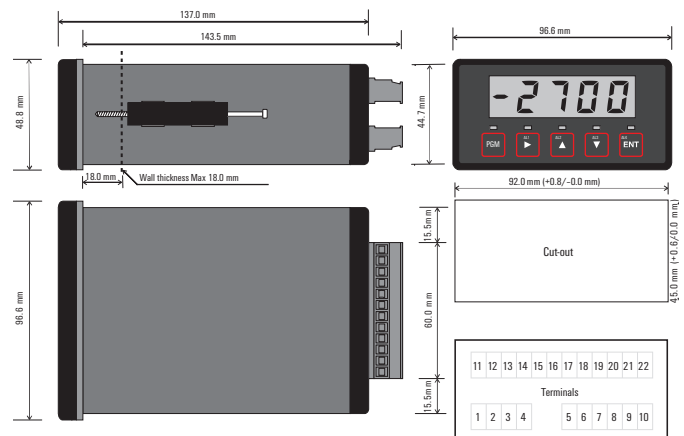
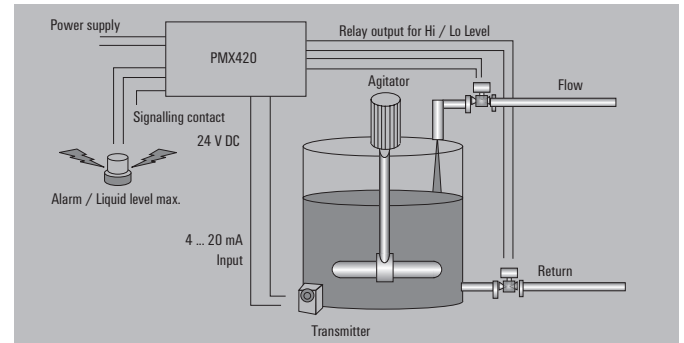

Common technical data

Display	
Type	4 Digits, red LED, 14.2 mm
Display value	Percent or real-value displayed
Display range	9999 to +9999
Status indicator	Alarm channel 1-4; status LED
Input	
Type	Current or voltage input is programmable
Input current limits	-22...+22 mA (preset for 4...20 mA)
Input voltage limits	-11...+11 V
Input resistance	25 Ω (current input) or 1.5 M Ω (voltage input)
Resolution	4 μ A / 2 mV
Sensor current	4...20 mA
Feed voltage	24 V DC \pm 1.5 V DC (bis 25 mA)
Attenuation factor	0...99; programmable digital filter
Functions	
Values	Linear or $\sqrt{\quad}$
General information	
Supply voltage	18...50 V DC, other voltages on request
Power input	8.5 W @ 24 V DC
Accuracy	Typically \pm 0.1 % of signal range
Linearity	< 0.05 %
Repeat accuracy	\pm 0.02 of signal range
Humidity	0...90 % (no condensation)
Temperature coefficient	< 0.02 % / $^{\circ}$ C at 100 %
Long-term drift	0.1 % / 10.000 h
Cut-off frequency (-3 dB)	5 Hz
Step response time	300 ms (10...90 %)
Impulse withstand voltage	4 kV (1,2/50 μ s)
Isolation voltage	2 kV input / output / power supply
Data backup	> 10 years without power supply
Ambient temperature (operational)/storage temperature	0 $^{\circ}$ C...60 $^{\circ}$ C / -25 $^{\circ}$ C...+70 $^{\circ}$ C
EMC standard	DIN EN 61326
Approvals	CE, cULus

Connections

Terminal	Signal	
1	-	Supply voltage
2	+	High level
3	+	Supply voltage
4	-	Low level
5	Signal + sensor supply	Inputs
6	Configuration	
7	Signal + voltage input	
8	Signal + current input	
9	Signal 0 V	
10	Not used	
11	NC contact	Alarm channel 1
12	Common	(only PMX-420Plus)
13	NO contacts	Alarm channel 2
14	NC contact	
15	Common	Alarm channel 3
16	NO contacts	
17	NO contacts	Alarm channel 4
18	Common	
19	NO contacts	Analogue Output
20	Common	
21	Signal +	
22	Signal -	

Process value monitoring with LED display

PMX420 Series

Universal, 4-character current/voltage display

- Display instrument for control panel installation
- Pluggable connection terminals
- 4-character, scalable display
- Simple menu-driven configuration

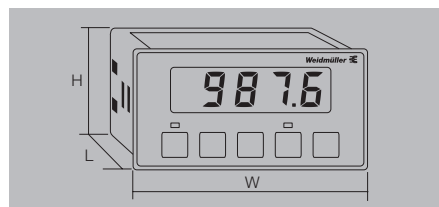

Technical data

Alarm	
Type	
Scaling	
Output current	
Output voltage	
Transmit function	
Load impedance, voltage/current	
Residual ripple	
Alarm	
Type	
Number of channels	
Type of contact	
Switching current	
Insulation voltage	
Leakage current quenching	

PMX420Plus

Display with analogue output and 4 alarm channels



Adjustable output for current or voltage	
Variable	
0...22 mA	
0...11 V	
direct or inverted	
850 Ω @ 20 mA (current output) / < 500 Ω (voltage output)	
≤ 20 mV _{ss}	
Internal Alarm via LED or output signal to external controller	
4	
2 CO contact und 2 NO contacts	
5 A @ 240 V AC, 10 A @ 24 V DC	
2 kV input / power supply	
internal	

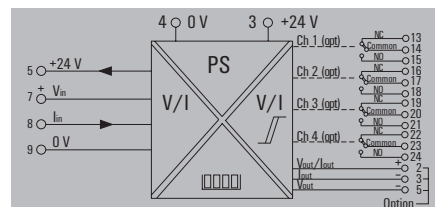

Connections

Terminal	Signal	
1	-	Supply voltage
2	+	High level
3	+	Supply voltage
4	-	Low level
5	Signal + sensor supply	Inputs
6	Configuration	
7	Signal + voltage input	
8	Signal + current input	
9	Signal 0 V	
10	Not used	
11	NC contact	Alarm channel 1
12	Common	
13	NO contacts	Alarm channel 2
14	NC contact	
15	Common	Alarm channel 3
16	NO contacts	
17	NO contacts	Alarm channel 4
18	Common	
19	NO contacts	Alarm channel 4
20	Common	
21	Signal +	Analogue Output
22	Signal -	

Dimensions	
Clamping range (nominal / min. / max.)	mm ²
Length x width x height	mm
Note	

Screw connection	
1.5 / 0.5 / 2.5	
137 / 96.6 / 48.8	
Note	

Ordering data

Type	Qty.	Order No.
PMX420Plus	1	7940018957

Note

Accessories

Note

PMX420 Series

Universal, 4-character current/voltage display

- Display instrument for control panel installation
- Pluggable connection terminals
- 4-character, scalable display
- Simple menu-driven configuration

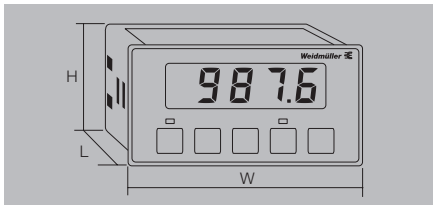

PMX420

Display

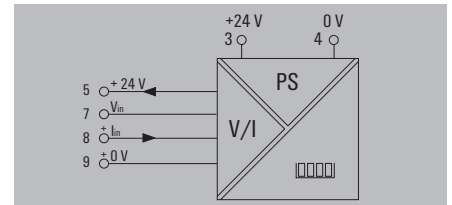

Technical data

Display	
Type	4-digit, red LED, 14.2 mm
Scaling	
Display range	-9999...9999
Status indicator	
Inputs	
Type	Adjustable input for current or voltage
Input current	-22...+22 mA (preset to 4...20 mA)
Input resistance	25 Ω (current input) or 1.5 MΩ (voltage input)
Resolution	4 μA / 2 mV
Sensor current	4...20 mA
Current output	
Transfer functions	
Power supply	
Supply voltage	18...50 V DC, other voltages on request
Input	
Attenuation factor	0...99, programmable digital filter
General data	
Sampling rate	
Linearity	< 0.05 %
Repeat accuracy	
Temperature coefficient	
Long-term drift	0.1 % / 10.000 h
Cut-off frequency (-3 dB)	5 Hz
Step response time	
Insulation coordination	
Rated voltage	
Overvoltage category	
Impulse withstand voltage	4 kV (1.2/50 μs)
Insulation voltage	2 kV input / power supply
Ambient temperature (operational)	0 °C...+60 °C
Storage temperature	-25 °C...+70 °C
Pollution degree	
Humidity	0...90 % (no condensation)
Dimensions	
Clamping range (nominal / min. / max.)	mm ²
Length x width x height	mm
Note	

Screw connection	
Type	1.5 / 0.5 / 2.5
Qty.	1
Order No.	7940018956

Ordering data

Voltage input/Current input

Note

Accessories

Note

Connections

Terminal	Signal	
1	-	Supply voltage
2	+	High level
3	+	Supply voltage
4	-	Low level
5	Signal + sensor supply	Inputs
6	Configuration	
7	Signal + voltage input	
8	Signal + current input	
9	Signal 0 V	
10	Not used	

Indicators and configurable displays for temperature

PMX400 SERIES

Four-digit temperature and frequency displays with analogue-value read-out and alarm monitoring

The PMX400 SERIES consists of two modules:

- Temperature display
- Frequency display / tachometer

A variety of temperature or frequency signals can be processed. On the output side, optional analogue signals are available, as well as either two or four relay contacts for alarm monitoring. The PMX400 HZX frequency display module offers, as default, two open-collector outputs as the relay contacts. The outputs are designated for the alarm function. An integrated power supply can be used for supplying external sensors and input devices.

Technical features:

- Four-digit digital LED display
- Up to four alarm channels and an analogue current/voltage output
- Retrieval of min. and max. values
- Integral power supply for active sensors
- DC power supply
- Complete electrical isolation
- LED alarm status indication
- DIN-standard 1/8 front panel with IP 65 protection
- Decimal point can be adjusted to any position
- Configurable via front-panel keypad

Typical application of PMX400

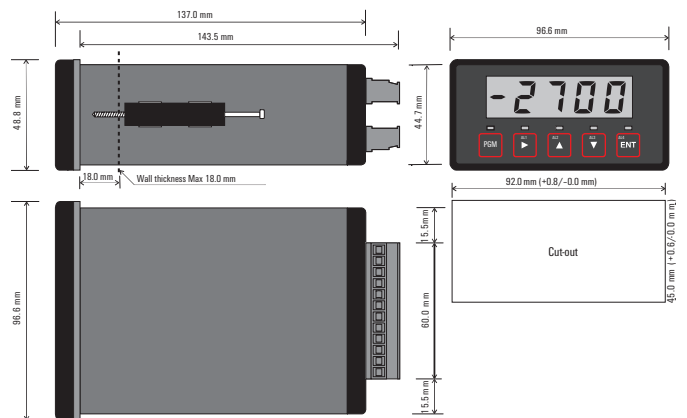
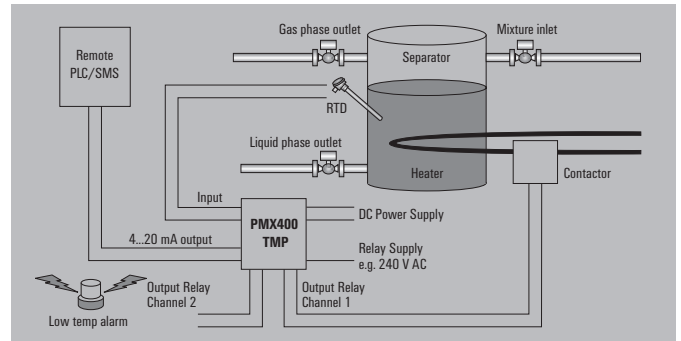

Common technical data

Display	
Type	Four-digit, red LED, 14.2 mm
Display value	Percent or real-value displayed
Display range	-9999 to +9999
Status indicator	Alarm channel 1-4; Status LED
Output	
Type	Current or voltage output
Scaling	Variable
Output signal limits	0...20 mA or 0...11 V
Load resistance	≤ 850 Ω (current), ≥ 1 MΩ (voltage)
Residual ripple	< 20 mV _{ss}
Transmit function	direct or reverse
General information	
Accuracy	Typically ± 0.1 % of signal range
Linearity	≥ 0.05 %
Repeat accuracy	± 0.02 % of signal range
Humidity	0...90 % (no condensation)
Temperature coefficient	≤ 0.02 % / °C
Long-term drift	0.1 % / 10,000 h
Cut-off frequency (-3 dB)	5 Hz
Impulse withstand voltage	4 kV (1.2/50 μs)
Isolation voltage	1 kV input / output / power supply
Data backup	≥ 100 years (without power supply)
Ambient temperature (operational)/storage temperature	0 °C...60 °C / -25 °C...75 °C
EMC standard	DIN EN 61326
Approvals	CE, cULus

Connections	
Terminal	Signal
1	-
2	+
3	Signal +
4	Signal - current
5	
6	
7	
8	
9	
10	
11	
12	
8	
9	
10	
11	
12	
8	
9	
10	
11	
12	
13	NO contacts
14	Common
15	NC contact
16	NO contacts
17	Common
18	NC contact
19	
20	
21	
22	
23	
24	

Connections

Terminal	Signal	
1	-	Supply voltage
2	+	
3	Signal +	Analogue output
4	Signal - current	(only for AO version)
5		
6		
7		
8		
9		
10		
11		
12		
8		
9		
10		
11		
12		
8		
9		
10		
11		
12		
13	NO contacts	
14	Common	Alarm channel 1
15	NC contact	(only for 4RO version)
16	NO contacts	
17	Common	Alarm channel 2
18	NC contact	(only for 4RO version)
19		
20		
21		
22		
23		
24		

Optional, depending on type

Depending on the individual module

Process value displays with LED display

PMX400 Series

- Temperature measuring and monitoring (PT100, thermocouple, mV)
- Automatic sensor detection
- Automatic compensation for PT100 measurement leads
- Cold-junction compensation for thermocouple inputs
- Display instrument for control panel installation

PMX400TMP

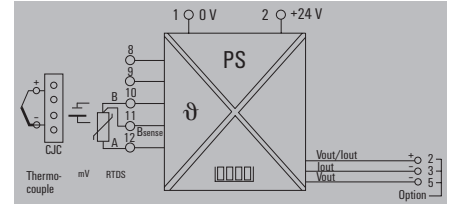
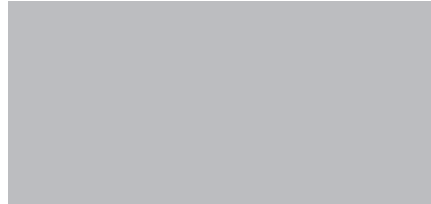
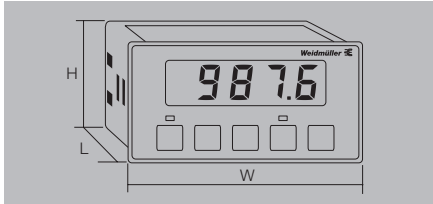

Technical data

Display	
Display value	Percentage or real value display
Input	
Type	Thermocouple, PT100 RTD or mV
Input signal	Configurable for 10 ranges
cold junction compensation	automatic
Cable-length compensation	automatic
General data	
Supply voltage	20...28 V DC
Power consumption	6 W @ 24 V DC
Step response time	300 ms (10...90 %)
Sampling rate	5x pro s
Attenuation factor	0...99, programmable digital filter
Type	4-digit, red LED, 14.2 mm
Insulation voltage	Voltage input/ current input
EMC standards	1 kV input / output / power supply
Approvals	DIN EN 61326
	CE, cULus

Display	
Display value	Percentage or real value display
Input	
Type	Thermocouple, PT100 RTD or mV
Input signal	Configurable for 10 ranges
cold junction compensation	automatic
Cable-length compensation	automatic
General data	
Supply voltage	20...28 V DC
Power consumption	6 W @ 24 V DC
Step response time	300 ms (10...90 %)
Sampling rate	5x pro s
Attenuation factor	0...99, programmable digital filter
Type	4-digit, red LED, 14.2 mm
Insulation voltage	Voltage input/ current input
EMC standards	1 kV input / output / power supply
Approvals	DIN EN 61326
	CE, cULus

Connections

Terminal	Signal	
1	-	Supply voltage
2	+	
6	Connections for changing setup	Configuration
7		
8	Cold-junction compensation	Thermocouple inputs
9		
10		
11	Not used	
12		
8	Not used	RTD inputs
9		
10		
11	B	mV inputs
12	B-Sense	
	A	
8	Not used	
9		
10		
11	mV Signal -	
12	mV Signal +	
	Not used	

Thermocouple (type J, K, N, T, E, B, S, R), RTD or mV signals

Input Type	Max. display range	
	highest	lowest
J	870 °C (1598 °F)	-50 °C (-58 °F)
K	1372 °C (2502 °F)	
N	1300 °C (2372 °F)	
T	400 °C (752 °F)	
E	700 °C (1292 °F)	
B	1800 °C (3272 °F)	0 °C (32 °F)
S	1768 °C (3214 °F)	-50 °C (-58 °F)
R	1768 °C (3214 °F)	-50 °C (-58 °F)
RTD	820 °C (1508 °F)	-220 °C (-364 °F)
mV	200 mV	-200 mV

Dimensions	
Clamping range (nominal / min. / max.)	mm ²
Length x width x height	mm
Note	

Screw connection	
1.5 / 0.5 / 2.5	
137 / 96.6 / 48.8	
Note	

Ordering data

	without analogue / alarm output
--	---------------------------------

Type	Qty.	Order No.
PMX400TMP	1	7940017862

Note	
------	--

Accessories

Note	
------	--

PMX400 Series

- Frequency measuring and monitoring (3-wire NPN/PNP, NPN/PNP Open Collector, TTL logic, solid-state switch, potential-free contacts)
- Integrated power supply for external sensors
- Two outputs for monitoring limit-values
- De-bouncing of switched input pulses

PMX400HZX

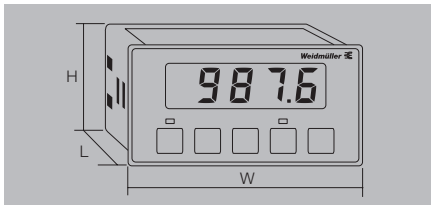

Technical data

Display	Display value
Input	Type Input signal Sensor supply Input voltage
Alarm (channel 1/2)	Type Rated switching current Rated switching voltage
Alarm (channel 3/4)	Type Switching current
General data	Supply voltage Power consumption Step response time Attenuation factor Type Insulation voltage EMC standards Approvals

Percentage or real value display
Adjustable frequencies Configurable for 4 ranges 12 V DC to 25 mA
Channel 1/2: transistor output channel 3/4: relay contact (CO)
200 mA 50 V DC
Channel 1/2: transistor output channel 3/4: relay contact (CO)
Channel 3/4: 3 A @ 240 V AC / 24 V DC (resistive load)
24 V DC ± 10 % 6 W @ 24 V DC < 220 ms (10...90 %)
0...99, programmable digital filter RO/AO version with 1 analogue output and 2 alarm outputs
1 kV input / output / power supply DIN EN 61326 CE; cULus

Dimensions	
Clamping range (nominal / min. / max.)	mm ²
Length x width x height	mm
Note	

Screw connection	
1.5 / 0.5 / 2.5	
137 / 96.6 / 48.8	
Note	

Ordering data

without analogue / alarm output	
with analogue/alarm output	

Type	Qty.	Order No.
PMX400HZX	1	7940015595
PMX400HZX RO/AO	1	7940011979

Note	
-------------	--

Accessories

Note	
-------------	--

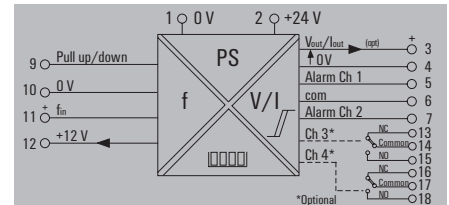

Connections

Terminal	Signal	
1	-	Supply voltage
2	+	
3	Signal +	Analogue output (only for AO version)
4	Signal -	
5	Common	Alarm channel 1 and 2 (only for 4RO version)
6	Channel 1	
7	Channel 2	
8	Configuration	Inputs/Configuration (Set-up: 12/8 connection)
9	Pull up / pull down	
10	Signal -	
11	Signal +	
12	12 V DC	
13	Common	Alarm channel 3 (only for 4RO version)
14	NC contact	
15	NO contacts	
16	Common	Alarm channel 4 (only for 4RO version)
17	NC contact	
18	NO contacts	

Input range	Offset	Resolution
0...9.999 Hz	0...9.998 Hz	0.001 Hz
0...99.99 Hz	0...99.98 Hz	0.01 Hz
0...999.9 Hz	0...999.8 Hz	0.1 Hz
0...9999 Hz	0...9998 Hz	1 Hz

AMS400A

Universal interface device

- Display instrument for control panel installation
- 1/8 DIN standard front
- IP 65 fully insulated
- Pluggable connection terminals

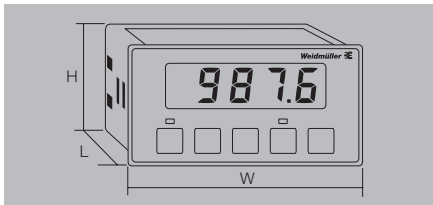

Technical data

Display	
Type	4-digit, red LED, 14.2 mm
Display value	Percentage or real value display
Display range	-9999...9999
Input	
Type	Current input or digital input (pulse-controlled or no-voltage contact)
Input signal	0...24 mA / 0...12 V DC
Input resistance	50 Ω (mA) / 10 MΩ (V)
Sampling rate	5x per sec. (current input)
Pulse width, min.	64 ms (digital input)
Output	
Type	Analogue and digital output
Output analogue	Current or voltage, configured with jumper
Output current	0...24 mA
Output voltage	0...18 V
Last resistor, max.	900 Ω @ 20 mA
Alarm (RO version only)	
Type	Status relay
Number of channels	2
Type of contact	CO contact
Ratings	3 A @ 240 V AC or 5 A @ 24 V DC
General data	
Supply voltage	24 V DC ± 10 %, other voltages on request
Power consumption	6 W @ 24 V DC
Accuracy	Typically ± 0.1 % of signal range
Repeat accuracy	± 0.02 % of signal range
Temperature coefficient	≤ 0.02 % / °C
Cut-off frequency (-3 dB)	5 Hz
Step response time	300 ms (10...90 %)
Impulse withstand voltage	4 kV (1.2/50 μs)
Insulation voltage	1 kV input / output / power supply
Ambient temperature / Storage temperature	0 °C...+60 °C / -25 °C...+70 °C
EMC standards	DIN EN 61326
Approvals	CE; cULus
Dimensions	
Clamping range (nominal / min. / max.)	mm ²
Length x width x height	mm
Note	

Ordering data

Analogue output

Note

Accessories

Note

AMS400A

Universal interface device



Connections	
Terminal	Signal
1	-
2	+
3	Signal +
4	Signal -
5	Signal - 0 V
6	Automatic / manual
7	Change operating mode
8	Common
9	Signal amplifier
10	Signal reduction
11	Signal +
12	Signal -

Type	Qty.	Order No.
AMS400A 4-20mA/AO	1	7940011895

Note

Note

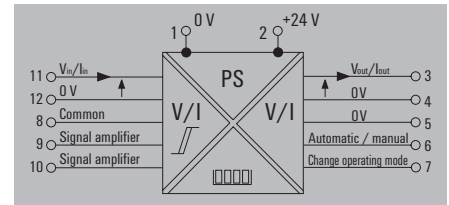

Connections

Terminal	Signal
1	-
2	+
3	Signal +
4	Signal -
5	Signal - 0 V
6	Automatic / manual
7	Change operating mode
8	Common
9	Signal amplifier
10	Signal reduction
11	Signal +
12	Signal -

Indicators with scalable displays

DI350

3½-digit LED display, auxiliary powered

The DI350 is a pair of inexpensive 3½-digit displays - one for analogue current (4-20 mA) and the other for voltage (0-10 V) signals, for use in industrial applications.

An integrated regulated power supply can be used to supply two-wire transmitters.

The decimal point can be moved to any of the positions (1.XXX, 1X.XX, 1XX.X or 1XXX) so that it can display values in any range.

The bright seven-segment LEDs are easily visible even in weak lighting. The special filtering properties of the front face give it a wide viewing angle.

F

The DIN-standard 1/8 front panel with IP 65 protection ensures reliable operation in wet areas. The connection uses pluggable screw-connection elements.

The DI350 models are hazardous area approved cuLus Ex (Class 1 Div. 2, Groups A, B, C & D)

Typical application of DI350

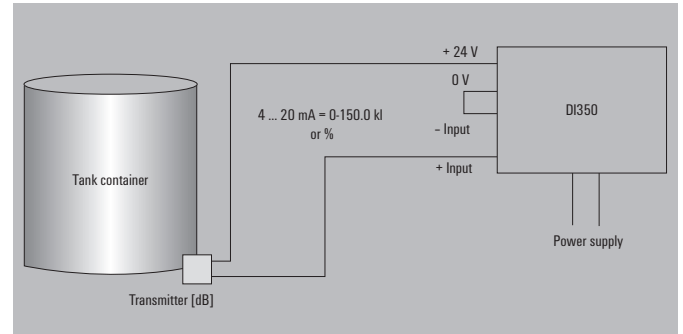

Wiring diagramm DI350

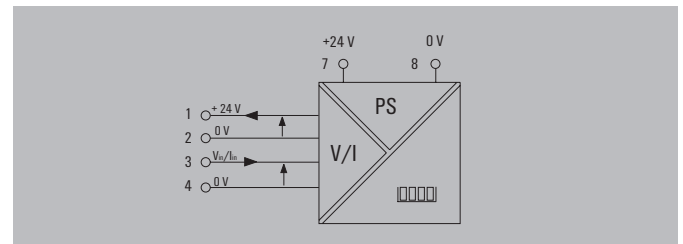

Connections

Terminal	Signal	
1	24 V DC power supply sensor	Inputs
2	0 V DC power supply sensor	
3	Input signal +	
4	Input signal -	
5		
6	Not used	
7	L -	Supply voltage
8	L +	

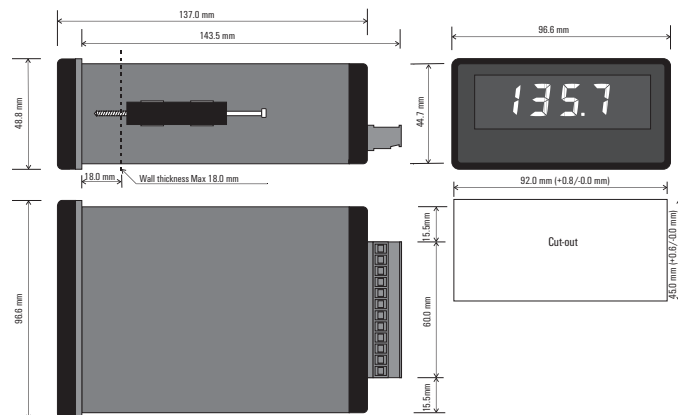

DI350

- Display instrument for control panel installation
- 1/8 DIN standard front
- 3½ digits
- IP 65 fully insulated
- Pluggable connection terminals

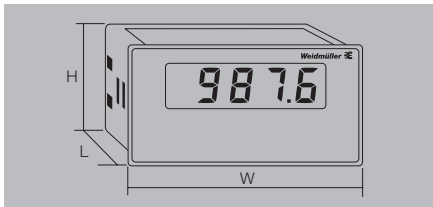

Technical data

Input	
Input signal	0...10 V
Input resistance	1 MΩ
Supply voltage	24 V DC (up to 25 mA)
Display	
Type	3.5 digits, red LED, 14.2 mm
Display range	-1999...1999
Display value	Percentage or real value display
Format	1-line / decimal point: 1.000, 100.0, 10.00
Settings	
Offset	± 1200 digital steps
Range of adjustment	20 - 2100 digital steps
General data	
Supply voltage	24 V DC (12...35 V DC)
Power consumption	6 W @ 24 V DC
Linearity	< 0.1 % typ.
Humidity	0...90 % (no condensation)
Temperature coefficient	≤ 0.02 % / °C
Long-term drift	0.1 % / 10.000 h
Step response time	200 ms (10...90 %)
Impulse withstand voltage	4 kV (1.2/50 μs)
Insulation voltage	1 kV input / power supply
Ambient temperature / Storage temperature	0 °C...+60 °C / -25 °C...+70 °C
EMC standards	DIN EN 61326
Approvals	CE; cULus; cULusEX

Dimensions	
Clamping range (nominal / min. / max.)	mm ²
Length x width x height	mm
Note	

Ordering data

Voltage input/Current input

Note	
------	--

Accessories

Note	
------	--

DI350

Display with voltage input



- Integrated power supply for external sensors
- Linearity with an accuracy of 0.1 % of the measuring range
- Complete galvanic isolation

Input	
Input signal	0...10 V
Input resistance	1 MΩ
Supply voltage	24 V DC (up to 25 mA)
Display	
Type	3.5 digits, red LED, 14.2 mm
Display range	-1999...1999
Display value	Percentage or real value display
Format	1-line / decimal point: 1.000, 100.0, 10.00
Settings	
Offset	± 1200 digital steps
Range of adjustment	20 - 2100 digital steps
General data	
Supply voltage	24 V DC (12...35 V DC)
Power consumption	6 W @ 24 V DC
Linearity	< 0.1 % typ.
Humidity	0...90 % (no condensation)
Temperature coefficient	≤ 0.02 % / °C
Long-term drift	0.1 % / 10.000 h
Step response time	200 ms (10...90 %)
Impulse withstand voltage	4 kV (1.2/50 μs)
Insulation voltage	1 kV input / power supply
Ambient temperature / Storage temperature	0 °C...+60 °C / -25 °C...+70 °C
EMC standards	DIN EN 61326
Approvals	CE; cULus; cULusEX

Screw connection	
1.5 / 0.5 / 2.5	
137 / 96.6 / 48.8	
Note	

Type	Qty.	Order No.
DI350 0-10V/0-100.0	1	7940011570

Note	
------	--

Note	
------	--

DI350

Display with current input



- Integrated power supply for external sensors
- Linearity with an accuracy of 0.1 % of the measuring range
- Complete galvanic isolation

Input	
Input signal	4...20 mA
Input resistance	22 Ω
Supply voltage	24 V DC (up to 25 mA)
Display	
Type	3.5 digits, red LED, 14.2 mm
Display range	-1999...1999
Display value	Percentage or real value display
Format	1-line / decimal point: 1.000, 100.0, 10.00
Settings	
Offset	± 1200 digital steps
Range of adjustment	20 - 2100 digital steps
General data	
Supply voltage	24 V DC (12...35 V DC)
Power consumption	6 W @ 24 V DC
Linearity	< 0.1 % typ.
Humidity	0...90 % (no condensation)
Temperature coefficient	≤ 0.02 % / °C
Long-term drift	0.1 % / 10.000 h
Step response time	200 ms (10...90 %)
Impulse withstand voltage	4 kV (1.2/50 μs)
Insulation voltage	1 kV input / power supply
Ambient temperature / Storage temperature	0 °C...+60 °C / -25 °C...+70 °C
EMC standards	DIN EN 61326
Approvals	CE; cULus; cULusEX

Screw connection	
1.5 / 0.5 / 2.5	
137 / 96.6 / 48.8	
Note	

Type	Qty.	Order No.
DI350 4-20mA/0-100.0	1	7940010185

Note	
------	--

Note	
------	--

Indicators and configurable displays

LPD350

3½-digit digital display, loop powered

The LPD350 is a compact, cost effective, 3½ digit digital indicator designed specifically for current loop signals. The decimal point can be moved to any position (1.XXX, 1X.XX, 1XX.X or 1XXX) so that it can display values in a range of ± 1999 .

The LPD350 uses a liquid crystal display which can be read even under poor lighting conditions.

No additional wiring is needed for a power supply. The user can simply break the loop and connect to the LPD350.

The housing has a DIN-standard 1/8 front panel with IP 65 protection. The connection uses pluggable screw-connection elements.

Technical features:

- Large 3½-digit digital LCD display
- 4...20 mA input
- Loop-powered two-wire design (125 Ω loop load)
- Direct or reverse-action display
- Linearity is $\pm 0.1\%$ of the corresponding signal range
- DIN-standard front-panel with IP 65 protection
- Pluggable screw-connection mechanism
- Hazardous area approved cuLus Ex (Class 1 Div. 2, Groups A, B, C & D)

Typical application of LPD350

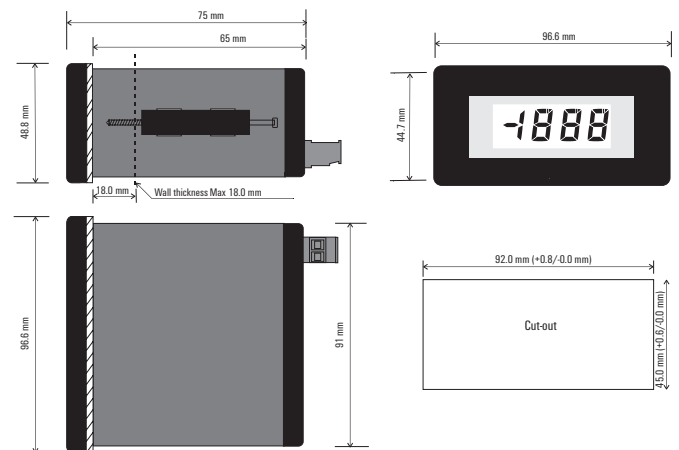
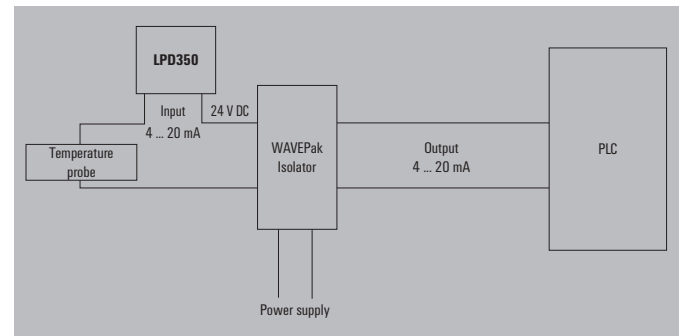

LPD350

- Display instrument for control panel installation
- 1/8 DIN standard front
- 3½ digits
- IP 65 fully insulated
- Pluggable connection terminals

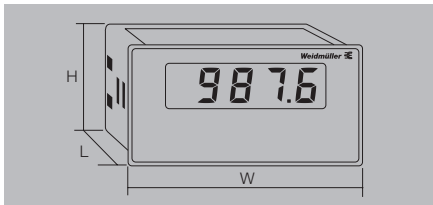
**Technical data****Input**

Input current
Voltage drop
Input resistance
Input current, max.
Input current, max. when wired incorrectly

Display

Type
Display range
Format

Settings

Offset
Range of adjustment

General data

Accuracy
Repeat accuracy
Temperature coefficient

Step response time
Sampling rate
Ambient temperature / Storage temperature
EMC standards
Approvals

Dimensions

Clamping range (nominal / min. / max.) mm²
Length x width x height mm

Note**Ordering data**

Current input

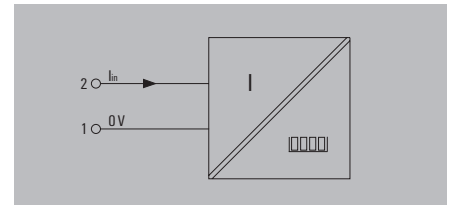
Note**Accessories****Note****LPD350****Current input****Connections**

Terminal	Signal
1	Input -
2	Input +

4...20 mA
2.5 V @ 20 mA
125 Ω
100 mA constant / 500 mA for 10 s
500 mA constant

3.5 digits, black LCD with clear background, 12.7 mm
-1999...1999
Single-line

± 1999 digital steps in two switching ranges
0...3998 in three switching ranges

± 0.05 % from signal range ± 1 digital step
± 0.05 % of signal range
Offset ± 0.1 digital steps per °C
adjustment range ± 0.1 digital steps per °C

200 ms (10...90 %)
2,5 x pro s
-20 °C...+70 °C / -25 °C...+85 °C
DIN EN 61326

CE; cULus; cULusEX; GOSTME25

Screw connection

1.5 / 0.5 / 2.5
75 / 96.6 / 48.8

Type	Qty.	Order No.
LPD350 4-20mA/0-100.0	1	7940010163

Configurable IP 67 field-mounted LCD indicator LPD405F

4½-digit display, loop powered

The display is loop powered by the 4...20 mA current loop with no external supply required. The twenty-mm LCD displays can be read even under poor light conditions.

A sheet of perforated self-adhesive labels is included. They include standard engineering units and can be used for all label needs.

The electronic subassembly is housed in a rugged, glass reinforced polycarbonate, IP 67 case. This housing is suitable for any industrial environment.

Optionally available is a pipe mounting bracket which can be used for horizontal and vertical mounting.

Technical features:

- Big 20 mm LCD display
- 4...20 mA inputs (two-wire loop-powered)
- Integrated signal linearisation ($\sqrt{\quad}$, $x^{3/2}$, $x^{5/2}$ or user-defined)
- Min./max. value display feature
- IP 67 protection
- Pipe mount bracket option
- Hazardous area approved cULus Ex (Class 1 Div. 2, Groups A, B, C & D)

Typical application of LPD405F

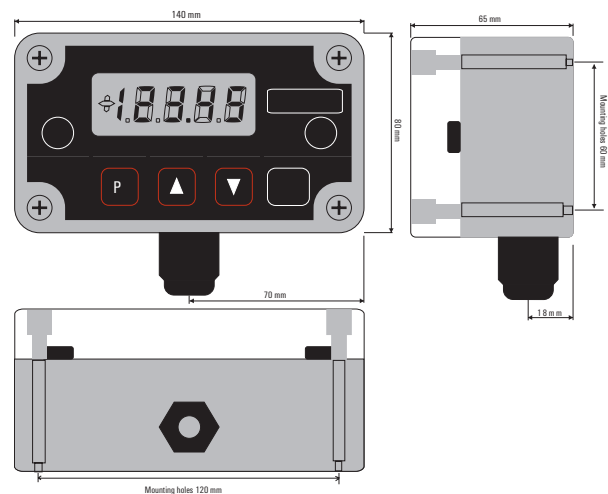
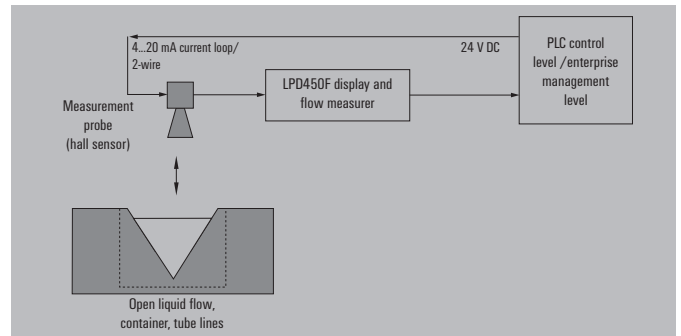

LPD450F

- Display instrument for outdoor use
- 4½ Digits
- IP 67 fully insulated
- Optionally available with fixing clips for pipe mounting

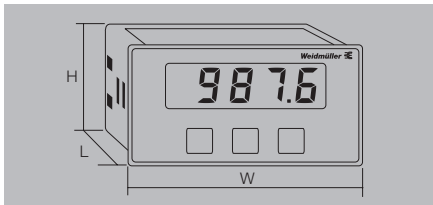

Technical data

Input	
Input current	4...20 mA
Transmit function	$\sqrt{\quad}$, $x^{3/2}$, $x^{5/2}$ or programmable (2-21 steps)
Display	
Type	4.5-character, black LCD with clear background, 20 mm
Display value	Percentage or real value display
Display range	± 19.999 (0.00...100.00 factory setting)
Decimal point	18888, 1.8888, 18.888, 188.88, 1888.8
General data	
Supply voltage	Loop powered, via 4...20 mA input
Voltage drop	< 4.3 V
Accuracy	$\pm 0.05\%$ from signal range ± 1 digital step
Repeat accuracy	$\pm 0.01\%$ of signal range
Temperature coefficient	Offset $\pm 0.01\%$ / °C adjustment range ± 0.1 digital steps or 0.01% / °C
Humidity	10...90% (no condensation)
Step response time	Programmable in 99 steps from 1...30 sec.
Sampling rate	16 x pro s
Change of display	2 x per sec.
Ambient temperature / Storage temperature	0 °C...+60 °C / -25 °C...+70 °C
EMC standards	DIN EN 61326
Approvals	CE; cULus; cULusEX; GOSTME25

Dimensions	
Clamping range (nominal / min. / max.)	mm ²
Length x width x height	mm
Note	

Ordering data

Current input

Note

Accessories

Note

LPD450F

Current input



Input	
Input current	4...20 mA
Transmit function	$\sqrt{\quad}$, $x^{3/2}$, $x^{5/2}$ or programmable (2-21 steps)
Display	
Type	4.5-character, black LCD with clear background, 20 mm
Display value	Percentage or real value display
Display range	± 19.999 (0.00...100.00 factory setting)
Decimal point	18888, 1.8888, 18.888, 188.88, 1888.8
General data	
Supply voltage	Loop powered, via 4...20 mA input
Voltage drop	< 4.3 V
Accuracy	$\pm 0.05\%$ from signal range ± 1 digital step
Repeat accuracy	$\pm 0.01\%$ of signal range
Temperature coefficient	Offset $\pm 0.01\%$ / °C adjustment range ± 0.1 digital steps or 0.01% / °C
Humidity	10...90% (no condensation)
Step response time	Programmable in 99 steps from 1...30 sec.
Sampling rate	16 x pro s
Change of display	2 x per sec.
Ambient temperature / Storage temperature	0 °C...+60 °C / -25 °C...+70 °C
EMC standards	DIN EN 61326
Approvals	CE; cULus; cULusEX; GOSTME25

Screw connection	
1.5 / 0.5 / 2.5	
65 / 140 / 80	
Note	

Type	Qty.	Order No.
LPD450F 4-20mA	1	7940010236

Note

Note

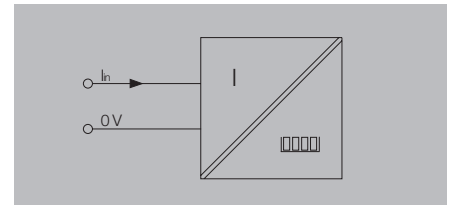

Mounting sketch

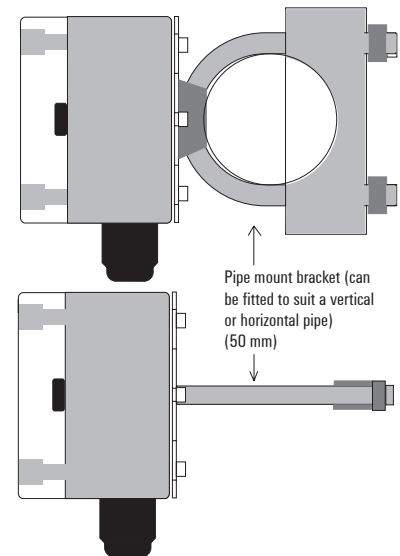

Accessories Analogue Signal Conditioning

Accessories Analogue Signal Conditioning	Accessories Analogue Signal Conditioning – Overview	G.2
	USB configuration adapter	G.4
	CH20M DIN rail bus	G.6
	ACT20 power-feed modules for rail bus	G.8
	ACT20X/ACT20C/ACT20P – Accessories	G.10
	MICROSERIES/ACT20M – Accessories	G.11
	MCZ/WAVE – Accessories	G.12
	Calibrators	G.14

Accessories Analogue Signal Conditioning

Configure, calibrate, mount, mark, (cross-) connect.

A comprehensive line of accessories is available for the analogue signal converter product family. The line includes configuration adapters for software-programmable products, interface modules, calibrators and mounting accessories (such as cross-connectors, end plates and terminal connectors) – all naturally in the top Weidmüller quality that you've come to expect.



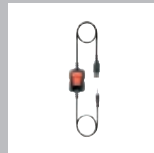

USB configuration interface



CH20M DIN rail bus



Power supply modules for rail bus



ACT20X/ACT20P – Accessories



**MICROSERIES ACT20M
Accessories**



MCZ/Wave Accessories



Calibrators

CBX200

- Interface converter for configuration, with galvanic isolation
- USB port for connecting to PC
- TX and RX status displays
- WI-Manager and TTA Set configuration software programs, download at www.weidmueller.com

CBX200 USB



Technical data

Input	
Type	USB 2.0 (USB type A plug)
Input current	≤ 100 mA
Input resistance	22 kΩ
Input voltage	1.6 ... 5.6 V
Output	
Type	RS232 (4-pole 2.5-mm jack plug)
Output voltage	3.3 V regulated
Output current	3 A
Level on interfaces	1.8...5.6 V (automatically adapted)
Baud rate	≤ 115 kBd
Activation signal	9...15 V typ. 12 V / 4 mA
Insulation coordination	
Insulation voltage	2.5 kV (input / output)

Type	USB 2.0 (USB type A plug)
Input current	≤ 100 mA
Input resistance	22 kΩ
Input voltage	1.6 ... 5.6 V
Output	
Type	RS232 (4-pole 2.5-mm jack plug)
Output voltage	3.3 V regulated
Output current	3 A
Level on interfaces	1.8...5.6 V (automatically adapted)
Baud rate	≤ 115 kBd
Activation signal	9...15 V typ. 12 V / 4 mA
Insulation coordination	
Insulation voltage	2.5 kV (input / output)

The CBX200 USB is a USB2.0/RS232-interface converter with galvanic isolation. It has additional functionality for controlling and supplying the connected RS232 device. The CBX200 USB makes it possible to configure the intrinsically safe ACT20X product line and the WAVE TTA signal converter.
The CBX200 USB is not compatible with the CBX100 USB.

Table for selecting a configuration adapter

Product	CBX100	CBX200
ACT20X		X
WAVE TTA	X	X
ITX+	X	

Pin assignments for jack plug



DTR*	Vcc
0	3,3 V
1	0 V

Control input	RTS*	RS232 interface
12 V	1	active
12 V	0	active
0 V	1	active
0 V	0	not active

* RTS and DTR are internal control signals

Installation notes

The power supply to the device comes from the USB port via a USB type-A plug. The output-side of the RS232 interface uses a four-pole 2.5-mm jack plug to connect. This jack plug is also capable of activating the RS232 interface when needed with a 12-V control voltage. With the assistance of the DTM, the USB interface is diverted to a COM interface. The RS232 interface can be activated with an RTS signal (RTS = 1 → output activated) via the diverted COM interface. The jack plug is also capable of supplying the RS232 node with a regulated voltage of 3.3 V at 4 mA current. The DTR signal (DTR = 0 → supply activated) is used for control. It is also possible to query the status using the DSR signal (DSR = 0 → output activated).

The "WI-Manager" software, the "TTA Set" and the DTM library can all be downloaded free of charge from www.weidmueller.com.

Note

Note

Ordering data

Type	Qty.	Order No.
CBX200 USB	1	8978580000

Type	Qty.	Order No.
CBX200 USB	1	8978580000

Note

Note

Accessories

Note

Note

CBX100

- USB interface configuration adapter for configuring
- USB port for connecting to PC
- Tx and Rx status displays
- Configuration software (T-Set) can be downloaded at www.weidmueller.com



CBX100 USB



Technical data

Display
Status indicator
General data
Insulation voltage
Ambient temperature / Storage temperature
Humidity
Approvals

LED (send / receive)
500 V for 60 s
-20 °C...+70 °C / -25 °C...+70 °C
10...90 % (no condensation)
cULus

Table for selecting a configuration adapter

Product	CBX100	CBX200
ACT20X		X
WAVE TTA	X	X
ITX+	X	

Wiring diagram

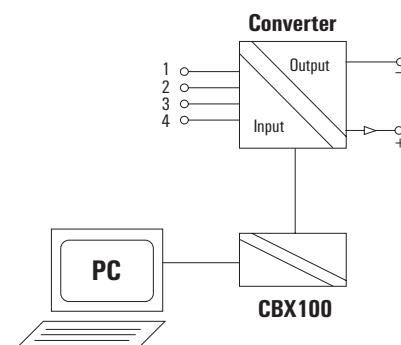

Note

Ordering data

--

Type	Qty.	Order No.
CBX100USB	1	7940025031

Note

Accessories

Note

CH20M DIN rail bus

Quick and safe power supply through the mounting rail.

This customer-friendly infrastructure solution brings power, signals and data to the rail in a quick and reliable manner. The DIN rail bus can replace the tedious individual wiring process with a flexible and uninterrupted system solution. As a result, the wiring overhead and the error rate are both reduced. The uninterrupted system bus is securely integrated within the 35 mm standard mounting rail. Whether 7.5 mm or 15 mm high, the custom-fit rail profiles are easy to install on all TS 35 standard rails in accordance with DIN EN 60715.

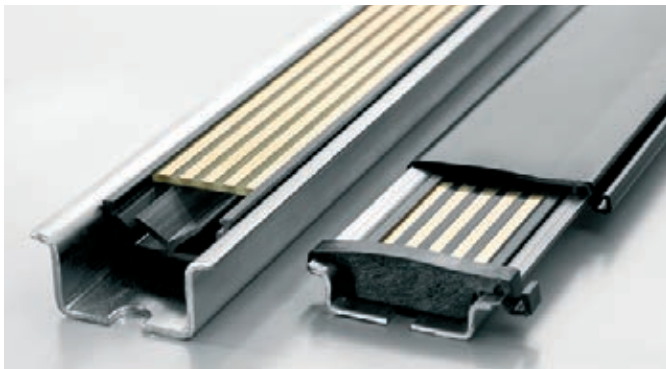

The resistant gold-plated contacts ensure a permanent and reliable contact. The ACT20M modules are simply snapped onto the mounting rail and are automatically in contact with the DIN rail bus.

The supply to the 24 V power supply can be from either one of the modules (up to 400 mA) or a separate power supply terminal (up to 4 A). This is sufficient for up to 120 modules. The ACT20-Feed-In-Basic provides a simple and compact (6 mm width) power supply terminal solution. The ACT20-Feed-In-Pro is a more powerful 22.5 mm wide solution. This makes a backup power supply that includes error messaging possible.

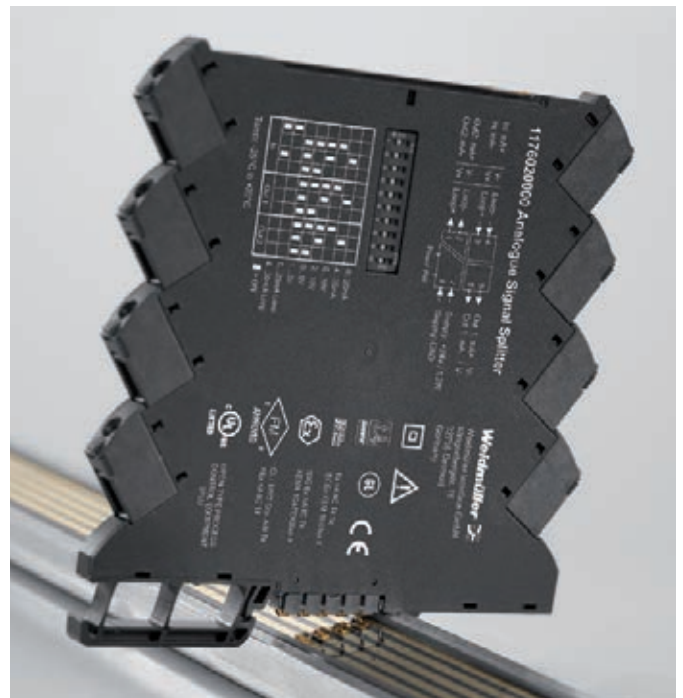

Rail bus accessories

CH20M BUS-PROFIL TS35x7.5/1000

Support section for bus circuit board



- Support section for TS 35 x 7.5
- Length: 250, 500 or 750 mm

Ordering data

Type	Qty.	Order No.
CH20M BUS-PROFIL TS35x7.5/250	10	1248150000
CH20M BUS-PROFIL TS35x7.5/500	10	1248160000
CH20M BUS-PROFIL TS35x7.5/750	5	1248170000

CH20M BUS-PROFIL TS35x15/1000

Support section for bus circuit board



- Support section for TS 35 x 15
- Length: 250, 500 or 750 mm

Ordering data

Type	Qty.	Order No.
CH20M BUS-PROFIL TS35x15/250	5	1248180000
CH20M BUS-PROFIL TS35x15/500	5	1248190000
CH20M BUS-PROFIL TS35x15/750	5	1248210000

CH20M BUS 4.50/05 AU/1000

Bus PCB



- Bus circuit board for use on TS 35 x 7.5 and TS 35 x 15
- Length: 250, 500 or 750 mm
- Five conductor paths, gold-plated
- Electrical rating: 63 V AC, 5 A/conductor path

Ordering data

Type	Qty.	Order No.
CH20M BUS 4.50/05 AU/250	10	1248220000
CH20M BUS 4.50/05 AU/500	10	1248230000
CH20M BUS 4.50/05 AU/750	5	1248240000

CH20M BUS-ADP TS35/1000

Cover plate



- Cover plate for DIN rail bus
- Length: 250, 500 or 750 mm

Ordering data

Type	Qty.	Order No.
CH20M BUS-ADP TS35/250	10	1248250000
CH20M BUS-ADP TS35/500	10	1248260000
CH20M BUS-ADP TS35/750	5	1248270000

CH20M BUS-AP LI TS35x7.5 & 15

End plate



- End plate for DIN rail bus
- Fits on TS 35 x 7.5 and TS 35 x 15
- left

Ordering data

Type	Qty.	Order No.
CH20M BUS-AP LI TS35x7.5 & 15	50	1193160000

CH20M BUS-AP RE TS35x7.5 & 15

End plate



- End plate for DIN rail bus
- Fits on TS 35 x 7.5 and TS 35 x 15
- right

Ordering data

Type	Qty.	Order No.
CH20M BUS-AP RE TS35x7.5 & 15	50	1193170000

SET CH20M BUS 250MM TS 35X15

Set

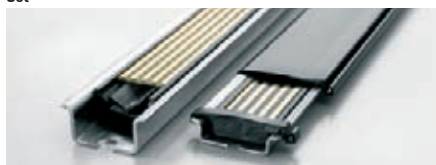

- SET consists of one each of
CH20M BUS 4.50/05 AU/250
CH20M BUS-ADP TS 35/250
CH20M BUS-AP LI TS 35X7.5 & 15
CH20M BUS-AP RE TS 35X7.5 & 15
CH20M BUS-PROFIL TS 35X15/250

Ordering data

Type	Qty.	Order No.
SET CH20M BUS 250MM TS 35X15	1	1335150000

SET CH20M BUS 250MM TS 35X7.5

Set

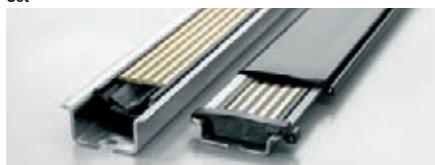

- SET consists of one each of
CH20M BUS 4.50/05 AU/250
CH20M BUS-ADP TS 35/250
CH20M BUS-AP LI TS 35X7.5 & 15
CH20M BUS-AP RE TS 35X7.5 & 15
CH20M BUS-PROFIL TS 35X7.5/250

Ordering data

Type	Qty.	Order No.
SET CH20M BUS 250MM TS 35X7.5	1	1335140000

TS 35x7.5 / TS 35x15

DIN rail

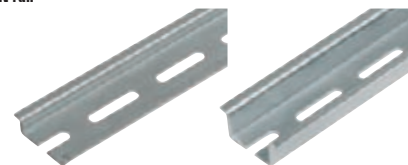

- DIN rail with slot
- Passivated galvanised steel

Ordering data

Type	Qty.	Order No.
TS 35X7.5/LL 1M/ST/ZN	10	0514510000
TS 35X15/LL 1M/ST/ZN	10	0236510000

Power-feed module for the CH20M DIN rail bus

4 A supply with backup supply and error analysis

The power-feed unit ACT20-FEED-IN-PRO-S supplies the devices on the CH20M DIN rail bus with 24 V DC. At the same time, the FEED-IN device reads the group error contact – optionally provided by the installed devices – from the CH20M rail bus and sends a message through the status relay to the external controller. Optionally, two power supplies can be connected for the primary and secondary supplies (backup). An installation in Zone 2 / Division 2 is also possible. Three LEDs show the status of the power supply and the error status.

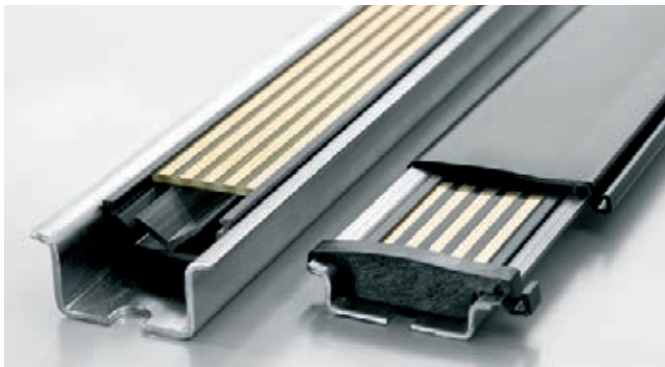

The FEED-IN-PRO can supply a maximum of 4 A to feed up to 120 devices mounted on a CH20M rail bus. Quick identification of errors on the DIN rail bus is through the internal status relay. The FEED-IN-PRO device immediately recognises and displays when a power supply has failed. The supply is then switched automatically to the redundant power supply.

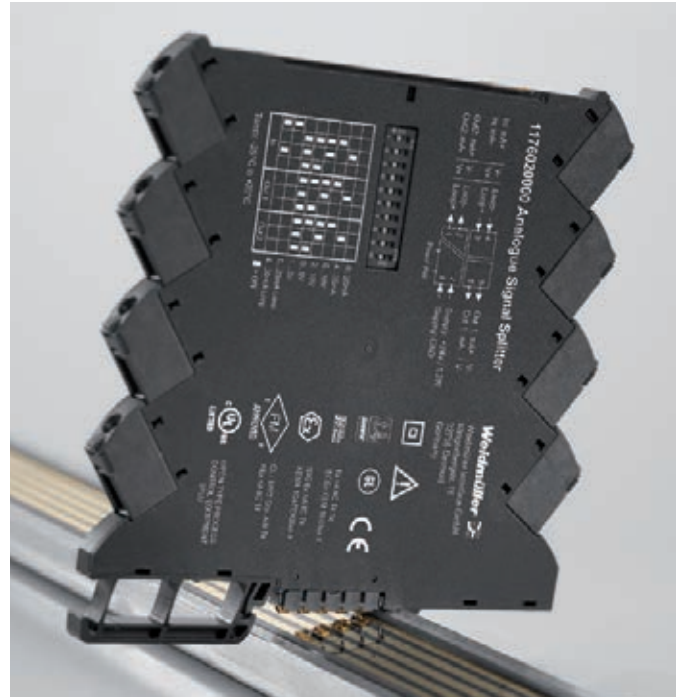

Weidmüller offers a compact and narrow 6 mm feed-in module as an alternative. This wires the terminal level directly to the DIN rail bus. Up to 80 modules can be fed with a maximum available current of 2.5 A.

ACT20 power-feed module

- Distributes the supply onto the busbar
- Compatible with Weidmüller CH20 DIN rail bus
- Optional connection for backup supply
- Approved for use in Ex-Zone 2 / Div. 2
- Monitoring of the supply voltage
- Alarm alerts via the status relay

ACT20-Feed-In-PRO-S

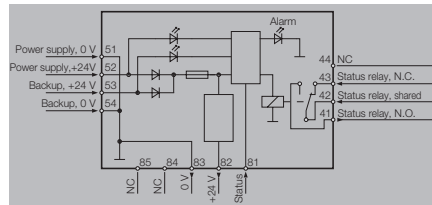

ACT20-Feed-In-BASIC-S

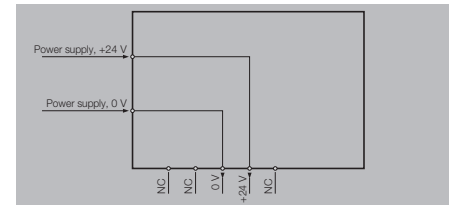

Technical data

Input	
Supply voltage	21.6...26.4 V DC
Input current	Max. 4 A
Trigger level for the power supply	21.6...26.4 V DC
	Fault < 21 V DC
Output, power supply	
Output voltage	Input voltage -0.5 V DC / 4 A
Output power	96 W
Output current	Max. 4 A
Output, status relay in safe zone	
Max. switching voltage, AC / Max. switching voltage, DC	250 V / 30 V
Continuous current	2 A AC / DC
AC power, max.	500 VA / 60 W
General data	
Degree of efficiency	0,976
Ambient temperature	< 2 W
Power consumption	IP 20
Protection degree	140
Weight	95 %, no condensation
Humidity	DEKRAATEX; DETNORVER; FMEX; GOSTME25; IECEXDEK
Approvals	

Input		
Supply voltage	21.6...26.4 V DC	
Input current	Max. 4 A	
Trigger level for the power supply	21.6...26.4 V DC	
	Fault < 21 V DC	
Output, power supply		
Output voltage	Input voltage -0.5 V DC / 4 A	
Output power	96 W	
Output current	Max. 4 A	
Output, status relay in safe zone		
Max. switching voltage, AC / Max. switching voltage, DC	250 V / 30 V	
Continuous current	2 A AC / DC	
AC power, max.	500 VA / 60 W	
General data		
Degree of efficiency	0,976	
Ambient temperature	< 2 W	
Power consumption	IP 20	
Protection degree	140	
Weight	95 %, no condensation	
Humidity	DEKRAATEX; DETNORVER; FMEX; GOSTME25; IECEXDEK	
Approvals		

Input		
Supply voltage	21.6...26.4 V DC	
Input current	0.5...2.5 A DC	
Trigger level for the power supply		
Output, power supply		
Output voltage	Corresponds to the input voltage	
Output power		
Output current	Equivalent to input current	
Output, status relay in safe zone		
Max. switching voltage, AC / Max. switching voltage, DC	250 V / 30 V	
Continuous current		
AC power, max.		
General data		
Degree of efficiency	100 %	
Ambient temperature	-20 °C...+60 °C	
Power consumption	IP 20	
Protection degree	70	
Weight	95 %, no condensation	
Humidity	cULus; DETNORVER; FMEX; GL; GOSTME25; IECEXKEM; KEMAATEX	
Approvals		

Dimensions	
Clamping range (nominal / min. / max.)	mm ²
Length x width x height	mm
Note	

Screw connection		
2.5 / 0.5 / 2.5		
119.2 / 22.5 / 113.6		
Note		

Screw connection		
2.5 / 0.5 / 2.5		
114.3 / 6.1 / 112.5		
Note		

Ordering data

Screw connection

Type	Qty.	Order No.
ACT20-FEED-IN-PRO-S	1	896550000

Type	Qty.	Order No.
ACT20-FEED-IN-BASIC-S	1	1282490000

Note

Note

Note

Accessories

Note

DIN mounting rail, see Accessories

DIN mounting rail, see Accessories

ACT20X/ACT20C/ACT20P



Connection terminals

Colour of housing	Release lever colour	Printing	Print colour	Type	Order No.	
black	blue	65/66/67/68	white	BHZ 5.00/04/90LH BK/BL PRT 65	1086480000	
		55/56/57/58	white	BHZ 5.00/04/90LH BK/BL PRT 55	1086470000	
		45/46/47/48	white	BHZ 5.00/04/90LH BK/BL PRT 45	1086460000	
		61/62/63/64	white	BHZ 5.00/04/90LH BK/BL PRT 61	1086420000	
		51/52/53/54	white	BHZ 5.00/04/90LH BK/BL PRT 51	1086410000	
		41/42/43/44	white	BHZ 5.00/04/90LH BK/BL PRT 41	1086400000	
	black	65/66/67/68	white	BHZ 5.00/04/90LH BK/BK PRT 65	1086240000	
		55/56/57/58	white	BHZ 5.00/04/90LH BK/BK PRT 55	1086230000	
		45/46/47/48	white	BHZ 5.00/04/90LH BK/BK PRT 45	1086220000	
		61/62/63/64	white	BHZ 5.00/04/90LH BK/BK PRT 61	1086180000	
		51/52/53/54	white	BHZ 5.00/04/90LH BK/BK PRT 51	1086170000	
		41/42/43/44	white	BHZ 5.00/04/90LH BK/BK PRT 41	1086160000	
	black	blue	35/36/37/38	white	BHZ 5.00/04/90LH BK/BL PRT 35	1086450000
			25/26/27/28	white	BHZ 5.00/04/90LH BK/BL PRT 25	1086440000
15/16/17/18			white	BHZ 5.00/04/90LH BK/BL PRT 15	1086430000	
31/32/33/34			white	BHZ 5.00/04/90LH BK/BL PRT 31	1086390000	
21/22/23/24			white	BHZ 5.00/04/90LH BK/BL PRT 21	1086380000	
11/12/13/14			white	BHZ 5.00/04/90LH BK/BL PRT 11	1086370000	
black		11/12	white	BHZ 5.00/02/90LH BK/BL PRT 11	1086250000	
		21/22	white	BHZ 5.00/02/90LH BK/BL PRT 21	1086260000	
		35/36/37/38	white	BHZ 5.00/04/90LH BK/BK PRT 35	1086210000	
		25/26/27/28	white	BHZ 5.00/04/90LH BK/BK PRT 25	1086200000	
		15/16/17/18	white	BHZ 5.00/04/90LH BK/BK PRT 15	1086190000	
		31/32/33/34	white	BHZ 5.00/04/90LH BK/BK PRT 31	1086150000	
		21/22/23/24	white	BHZ 5.00/04/90LH BK/BK PRT 21	1086140000	
		11/12/13/14	white	BHZ 5.00/04/90LH BK/BK PRT 11	1086130000	
41/42	white	BHZ 5.00/02/90LH BK/BK PRT 41	1086040000			

Cold-junction compensation terminals (optional for the ACT20X temperature modules)

1-channel					
black	blue	11/12/13/14	white		1160640000
2-channel					
black	blue	11/12/13/14	white		1160650000



Markers

Type	Version	Dimensions	Qty.	Order No.
ESG 66/20BHZ500/04	Individual markers	6.6 x 20 mm	200	1082540000
ESG 8/13,5/43,3 SAI AV	MultiCard (24 individual markers per MultiCard)	8 x 13.5 mm	5	1912130000

ACT20M



Ordering data markers

ACT20M marker
Note

Type	Qty.	Order No.
MS 5/7,5 MC NEUTRAL	320	1877680000
<small>The ACT20M voltage supply is cross-connected using the CH20M rail bus. Details are available on pages C.14 and G.6</small>		

ACT20P



Ordering data markers

ACT20M marker
Note

Type	Order No.
ESG 8/13.5/43.3 SAI AU	1912130000

Accessories MCZ



Ordering data end plates

Type	Qty.	Order No.
End plate		

Type	Qty.	Order No.
AP MCZ 1.5	50	8389030000



Ordering data cross-connection

Type	No. of poles
Plug-in cross-connection, yellow	2
Plug-in cross-connection, yellow	3
Plug-in cross-connection, yellow	4
Plug-in cross-connection, yellow	5
Plug-in cross-connection, yellow	10

Type	Qty.	Order No.
ZQV 4N / 2 GE	20	1758250000
ZQV 4N / 3 GE	20	1762630000
ZQV 4N / 4 GE	20	1762620000
ZQV 4N / 5 GE	20	7760711001
ZQV 4N / 10 GE	20	1758260000

G



Ordering data markers

Type	Qty.	Order No.
Multicard connector marker		

Type	Qty.	Order No.
WS10/6 MC	600	1828450000

WAVE Accessories



Ordering data cross-connection

Type	No. of poles
Plug-in cross-connection, black	2
Plug-in cross-connection, red	2
Plug-in cross-connection, blue	2
Plug-in cross-connection, yellow	2

Type	Qty.	Order No.
ZQV 2,5N/2 sw	60	1718080000
ZQV 2,5N/2 rt	60	1717900000
ZQV 2,5N/2 bl	60	1717990000
ZQV 2,5N/2 ge	60	1693800000



Ordering data markers

Type	Qty.	Order No.
Multicard connector marker		
Multicard connector marker		
Multicard connector marker		

Type	Qty.	Order No.
WS 10/5 MC NE WS	920	1635000000
WS15/5 MC	480	1609880000
WS10/6 MC	600	1828450000

Screw-connect connector strip for the WAVESERIES**3-pole**

Type	Printing	Order No.
BLZ 5.08/3 SN OR BEDR.	1, 2, 3	2242030000
BLZ 5.08/3 SN OR BEDR.	4, 5, 6	2242050000
BLZ 5.08/3 SN OR BEDR.	7, 8, 9	2242060000
BLZ 5.08/3 SN OR BEDR.	10, 11, 12	2242070000

2-pole

Type	Printing	Order No.
BLZ 5.08/02/180 SN OR BX	without labelling	1526460000
BLZ 5.08/02/180 SN OR PRT	1, 2	2246070000
BLZ 5.08/02/180 SN OR PRT	3, 4	2246080000
BLZ 5.08/02/180 SN OR PRT	5, 6	2246090000
BLZ 5.08/02/180 SN OR PRT	7, 8	2246100000

Portacal 1000EU

Calibration device for current and voltage signals

The Portacal 1000EU is a calibration device which is controlled by a microprocessor. It is used for current and voltage signals. It has three output modes for simulating signals:

- **Voltage source:** for the simulation of externally-supplied voltage transmitters
- **Current source:** for the simulation of externally-supplied current sensors
- **Current sink mode:** simulates the outputs of a two-wire (loop-powered) transmitter.

Commonly used calibration functions can be invoked for each mode by pressing a button. Up to 9 storage locations per mode are available to save the individual values.

Furthermore, the Portacal 1000EU can be programmed in a way that all modes can be cycled automatically. The corresponding values are controlled continually for a pre-defined time by means of a value storage. The following values can be checked and parameterised:

- Voltage outputs
- Current outputs
- Two-wire transmitter outputs

The Portacal 1000EU provides the necessary voltage supply for the sensor in order to check a two-wire transmitter.

Technical features:

- Complete diagnosis tool for current and voltage supply
- Measuring and simulating of voltage and current signals
- Simulation of function of signal transmitter, which can be auxiliary-powered or process-powered (two-wire type)
- Continually adjustable step and ramping function
- Accuracy < 0.05 % in all signal domains
- Light and portable
- Supply via NiMH rechargeable battery or comparable battery
- Signal tone at the press of a button

Typical application of Portacal 1000EU

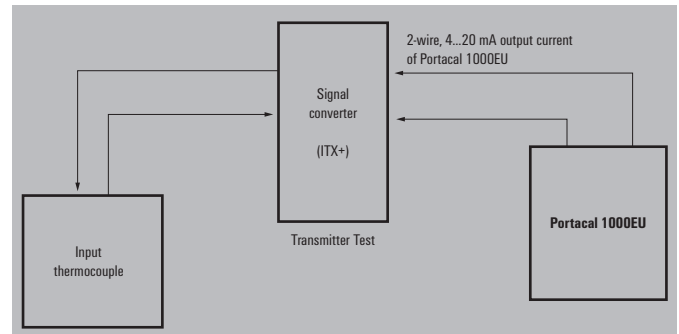

Portacal 1000EU

Instrument Calibrator

Technical data

Output voltage mode			
Output voltage	0...13 V		
Resolution	0.01 V		
Load current	0...10 mA		
Accuracy	±5 mV		
Residual ripple	< 1 mV		
Internal storage	Nine user-defined voltages		
Output current mode			
Output current	0...26 mA		
Resolution	0.01 mA		
Load resistance	600 Ω @ 20 mA (power source) 100 Ω (current sink)		
	9...45 V DC		
max. input voltage current sink	±5 μA		
Accuracy	< 1 μA		
Residual ripple	< 1 μA		
Internal storage	Nine user-defined currents		
Input voltage mode			
Input voltage	0...13 V		
Input resistance	200 kΩ		
Accuracy	±5 μA or ±1 digital step		
Input current mode			
Input current	0...26 mA		
Input resistance	47 Ω		
Accuracy	±5 μA or ±1 digital step		
Loop powered mode			
Type	Mode for loop-powered signal-converters		
Input current	0...26 mA		
Feed voltage	16 V ±10 %		
Accuracy	±5 μA or ±1 digital step		
Auto step/ramp mode			
Step	Output of each value within a certain time period		
Ramp	Output via a programmed ramp function		
Number of recorded values	2...9		
Time interval	10...4200 s		
Display			
Type	Four-digit display with LCD, 12 mm		
Status indicator	Five LEDs for output mode, signal amplification and reduction		
Display value	Percent or real-value displayed		
Keyboard			
Type	16 buttons with acoustic signal		
Calibration	Adjustable fixed values: 0, 2, 4, 8, 10, 12, 16, 18, 20 mA 0, 1, 2, 4, 5, 6, 8, 9, 10 V Nine freely-definable values 1 / 0.1 / 0.01 mA or V		
Memory			
Decimals			
General data			
Supply voltage	Battery, 4x type „AA“		
Temperature coefficient	< 0.01 % / °C at 100 %		
Ambient temperature (operational)/storage temperature	0 °C...60 °C / -25 °C...+70 °C		
Type of connection	Sockets		
EMC standard	DIN EN 61326		
Approvals	CE, cULus		
Dimensions			
Length x width x height	44 x 100 x 180 mm		
Note			
Ordering data			
Type	Type	Qty.	Order No.
	PORTACAL 1000EU	1	1439640000
Note	2 x 1 m test cable sw/rt with banana plug/terminal		
Accessories			
Note			

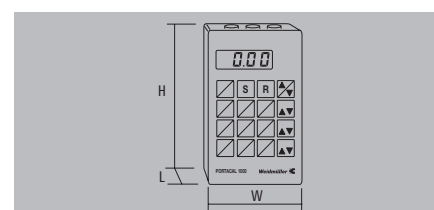

Portacal 275

Hand-held signal source and loop calibrator

The Portacal 275 is a precise hand-held signal source for current and voltage signals. It can be used in four modes which allows the calibration of standard current/voltage transmitters.

The operating mode "voltage source" simulates auxiliary-powered transmitters with proportional voltage outputs. The mode "current source" allows emulation of transmitters with proportional current outputs. The "mv source" mode simulates a variety of other analogue signals from many different applications. The "current sink" mode simulates the outputs of a two-wire (loop powered) transmitter.

The Portacal 275 is equipped with a scalable potentiometer (0 to 100 %) that can be adjusted in steps to an accuracy of 0.1 %. Together with the output-range switch, the potentiometer allows for a quick and precise adjustment of the signal value. A typical accuracy of ± 0.25 % is possible. An integrated test point, for connecting external measurement devices, allows for a higher accuracy of ± 0.1 %.

Technical features:

- Light and portable device
- Simulates loop-powered transmitter operation
- LED for indication of source/sink operating mode
- Current ranges: 0 to 20 mA / 4 to 20 mA / Voltage ranges: 0 to 5 V / 1 to 5 V / 0 to 200 mV
- 0.1 % accurate current source
- Test points for current output monitoring
- Switch select 0 %, 100 % or variable output
- Signal outputs can be adjusted with spindle potentiometer for high accuracy
- Powered from two 9 V block batteries

Portacal 275

Calibration device for current and voltage signals

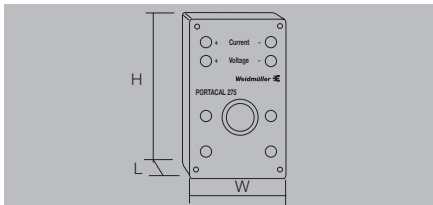

Portacal 275



Technical data

Output of voltage mode

Output voltage	0...5 V / 1...5 V; 0...200 mV / 40...200 mV
Resolution	0.01 V
Output resistance	250 Ω @ V / 10 Ω @ mV
Accuracy	< 0.2% (0% and 100%)

Output current mode

Output current	0 (4)...20 mA
Resolution	0.01 mA
Last resistor, max.	700 Ω (current source) ($V_{out} - 4$) / 0.02 Ω (current sink)

Output voltage, max. @ current sink	4...45 V DC
Accuracy	< 0.1% (0% and 100%)
Residual ripple	< 1 μA

Settings

Range of adjustment	0 (4)...20 mA / 0...200 mA (current source), 0...5 V (voltage source) or as current sink selectable with toggle switch
---------------------	--

Output, variable	0...100 % with precision potentiometer
Output, fixed	0 or 100 % with toggle switch

General data

Temperature coefficient	typ. 40 ppm @ °C
Accuracy	0.25 % of signal range
Supply voltage	Batteries, 2 x 9-V blocks 6...22 mA (current source) 2 mA (current sink)

Ambient temperature	0 °C...+60 °C
Storage temperature	-25 °C...+70 °C
Type of connection	Socket
EMC standards	DIN EN 61326
Approvals	CE, cULus

Dimensions

Length x width x height	mm	31 / 62 / 112
-------------------------	----	---------------

Note

Including two one-metre-long test leads sw/rt with banana plug/terminal and one bridge lead

Ordering data

Type	Qty.	Order No.
P275	1	7940010202

Note

Accessories

Note

Wiring diagram

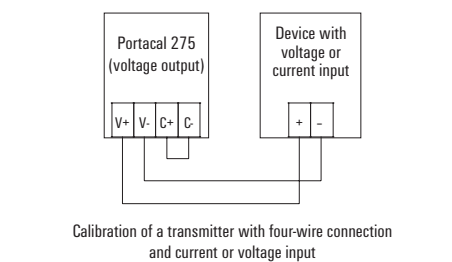
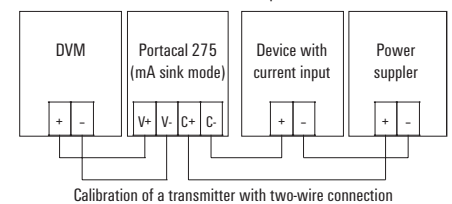
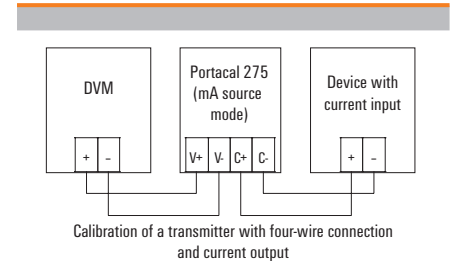

G

Technical appendix/Glossary

Technical appendix/Glossary	Dimensioned drawings	W.2
	Introduction	W.4
	Technical data	W.6
	FDT/DTM - The standard solution for device configuration	W.10
	EX basics	W.12
	ATEX	W.18
	Electrical data	W.20
	General technical information	W.22
	Glossary	W.26

Dimensioned drawings

ACT20M - Dimensioned drawings

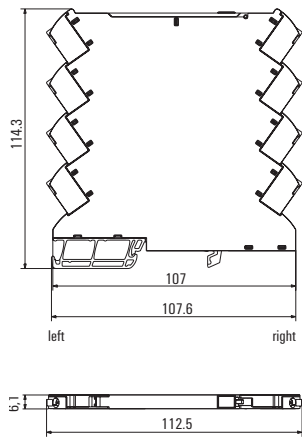

MICROSERIES

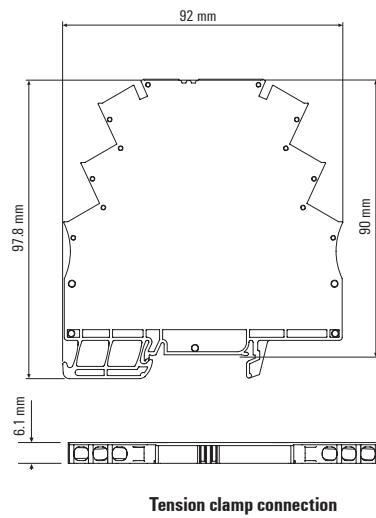
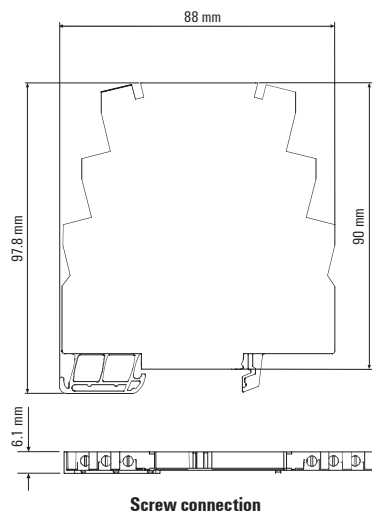

ACT20X/ACT20C/ACT20P

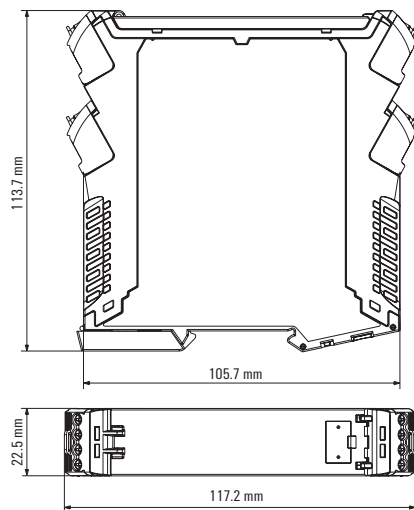

ACT20X HUI-SAO-LP-S

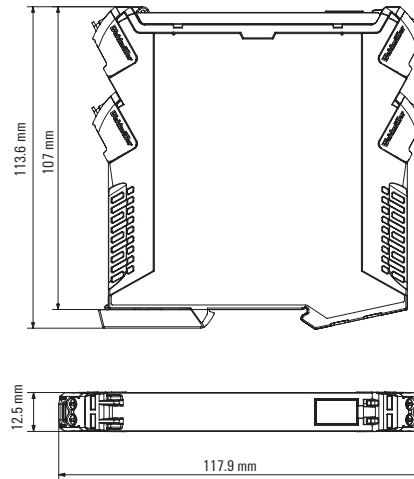

W

WAVEBOX S 22,5

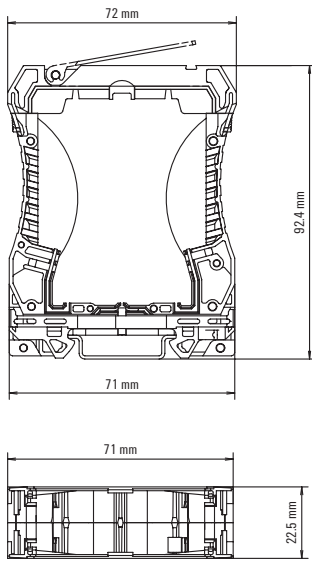

WAVEBOX L 22,5

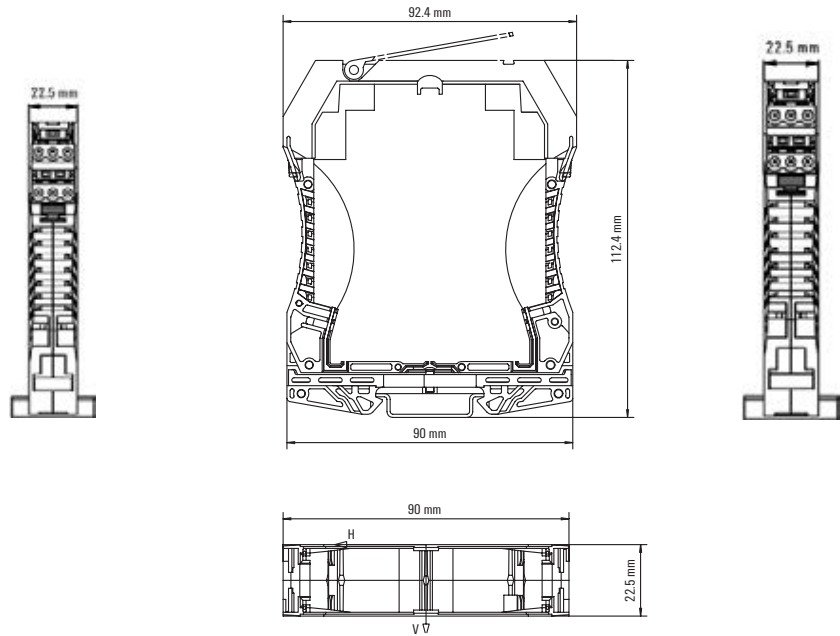

WAVEBOX 12,5

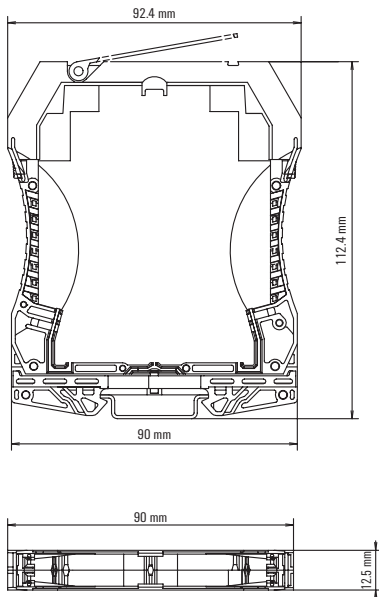

WAVEBOX 17,5

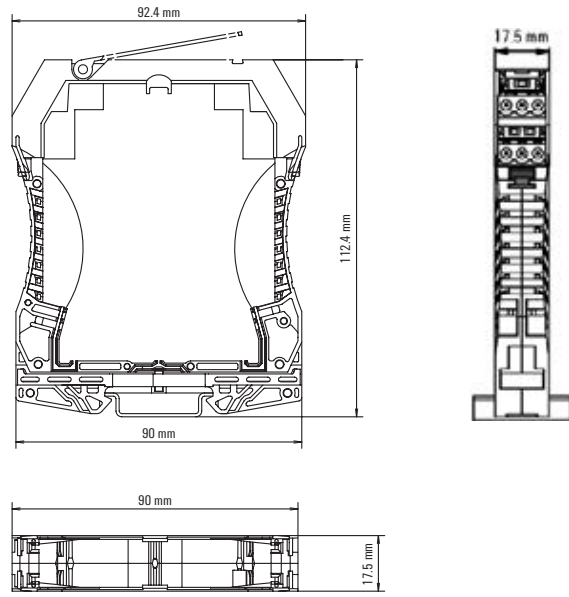

Different types of analogue signalling

The working environment can be measured in many different forms, e.g. in terms of temperature, humidity or air pressure. The values of these physical variables change constantly. Components that monitor the status and changes of a given environment and provide alerts of any changes must be able to continuously display the changes taking place.

In industrial and process automation, the outputs received from field sensors, switches and transmitters provides measurement and status data which becomes the analogue and digital inputs (AI and DI) for the control system. Similarly, control signals are passed from the control system to field control equipment such as analog and digital valves and actuators.

If automation processes are expected to reach certain statuses or keep them constant, then analogue signal conditioning is required. It is also important in areas where this has already been part of long established practice, e. g. in process engineering or the chemicals industry.

In process engineering, standardised electrical signals are normally used. Currents of 0 ... 20 mA, 4 ... 20 mA or voltages of 0 ... 10 V have become established as the output variables for sensors recording various different physical parameters.

Weidmüller takes account of the growing preference for automation – including and the resulting need for analogue signal conditioning – and offers a wide range of products tailor-made to the requirements involved in handling sensor signals. Units for the common signals (0 ... 20 mA, 4 ... 20 mA, 0 ... 10 V) generate an output signal as a proportional value of the variable input signal. "Protective separation", e.g. of the sensor circuit from the evaluation circuit, is also taken into account. "Protective separation" prevents mutual interference among several sensor circuits, e.g. as in the case of earth loops in interlinked measuring circuits.

The wide range of Weidmüller products completely covers the functions involved in signal conversion, signal separation and signal monitoring. The products can thus handle nearly all applications in industrial measuring technology, and safeguard elementary functions between field signals and further processing systems. The mechanical properties of the products are built up around a consistent concept.

Signal converters can be used with other Weidmüller products and combined with each other. They are designed to entail a minimum wiring workload and maintenance in both electrical and mechanical terms.

The product range contains the following functions:

- DC/DC converters
- Current converters
- Voltage converters
- Temperature converters for resistance thermometers (RTDs) and thermocouples
- Frequency converters
- Potentiometer transducers
- AC transducers
- Bridge transducers (strain gauges)
- Threshold monitoring modules
- AD/DA converters

The products are available as pure signal converters, or with 2-port or 3-port isolation and a choice of passive or output loop powered or auxiliary powered, depending on the application requirements.

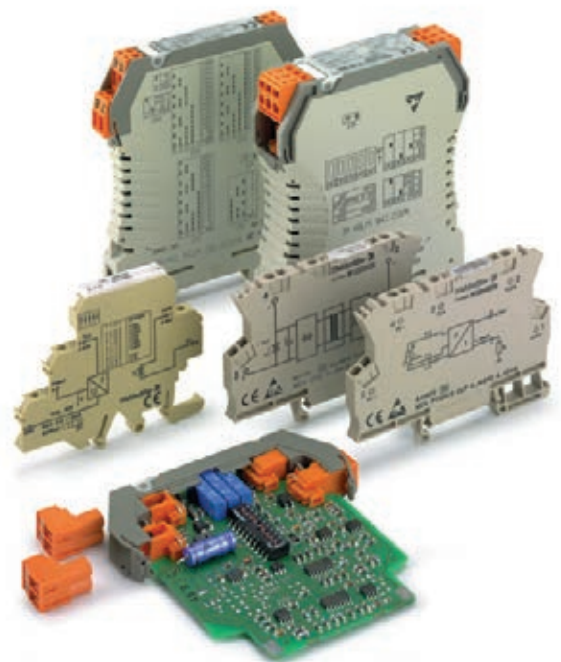

2-way isolation separates the signals from each other electrically and decouples the measuring circuits. Potential differences – caused by long line lengths and common reference points – are eliminated. Furthermore, the electrical separation protects against irreparable damage caused by overvoltages as well as inductive and capacitive interference.

3-way isolation decouples the supply voltage from the input and output circuits as well and enables the function to operate with just one operating voltage.

The **passive separator** offers an extra, decisive advantage – it requires no additional voltage supply. The power supply to the module is achieved via the input or output circuit and is transmitted to the input/output. This current loop feed is characterised by a very low consumption.

A number of products are available for temperature measurements. For example, **PT100** signals in 2-, 3- and 4-wire systems are converted into standard 0...20 mA, 4...20 mA and 0...10 V signals.

The modules for connecting conventional **thermoelements** are fitted with cold trap compensation as standard. Furthermore, they amplify and linearise the voltage signal provided by the thermocouple. This guarantees accurate analogue signal conditioning while eliminating sources of interference or error.

Frequency converters convert frequencies into standard analogue signals. Downstream controls can therefore directly process pulse strings for measuring rpm or speed.

AD or DA converters are required for bringing together the analogue signal forms mapping the local conditions and the digital processing in the process monitoring system. Weidmüller can supply such components for the customary 0...20 mA, 4...20 mA and 0...10 V input and output signals. 8-bit processors are available on the digital side.

Current-monitoring modules can be used to control DC and AC currents up to 60 amps. A switching operation is triggered when the set current values are not met or exceeded. Components with analogue outputs monitor the current load continuously via downstream controls.

Voltage monitoring modules can be used to monitor AC and DC voltages. Adjustable switching thresholds can be used to reliably detect and notify in the event of fluctuations caused by switching operations or mains overloads.

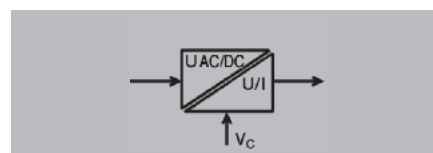
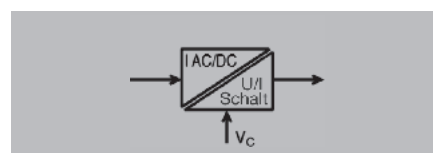
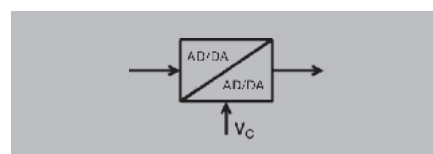
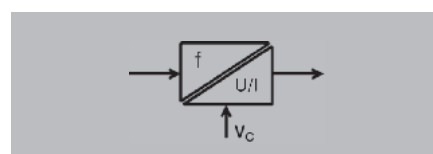
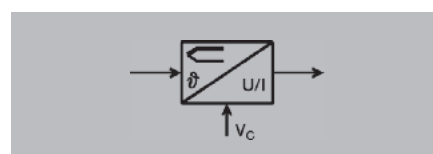
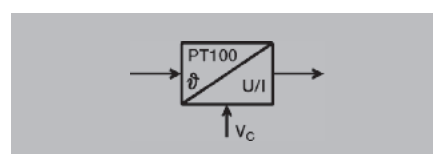
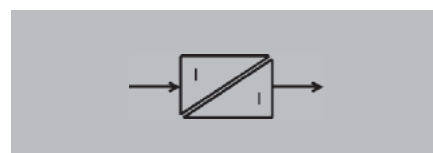
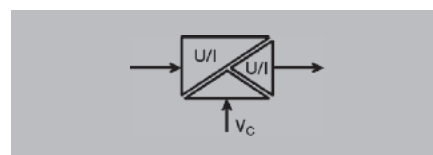
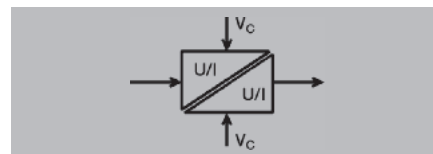

Technical data



Common Mode Noise Elimination

- Generally, signals emitted by sensors have low levels and are thus susceptible to capacitive and inductive interference, such as those generated by motors, frequency changers and other change processes. This noise contents the measuring value and frequently destroys expensive analog I/O cards in the control electronics. Through the utilisation of analogue signal isolators this interference, which usually actions both signal lines in common mode (push push), is effectively eliminated through the zero potential input.

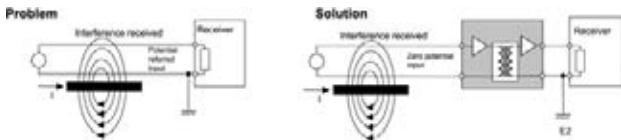

Active Isolator / Passive Isolator

- Active isolators draw their power supply from a separate supply terminal to ensure that they can operate perfectly. Depending upon the applications the input, output and additionally the power supply are isolated from each other. Only one supply is required for 3-port isolation. However, it is isolated from the input and output circuits. Thus even in the event of a short circuit, surge voltage or reverse polarity, the downstream control electronics cannot be damaged. Isolating the signals between the input and output can be conducted either optically or by transformer barrier depending upon the transfer rate. Active isolators are non interacting, i.e. a change in the load does not exert any influence on an input circuit.
- Passive isolators generate the current required for the supply from the measuring signal. The current required internally is so small that transfer problems do not occur here.
- The feed can be effected from either the input or the output side. Isolation is by transformer barrier. The advan-

tages are: cessation of network influences, outstanding accuracy, low signal delay and low potential requirement. Passive isolators are not interacting; a change in load in the output circuit will influence the input circuit.

Ground Loops

- The voltage supply's secondary side is earthed for the purpose of setting up fast and secure ground loop monitoring. If an analogue signal is fed in from a separate voltage supply or if the sensing device itself is earthed, then transient currents will flow between the ground potentials across the interconnected ground connectors, which in turn corrupts the measuring signal. Analogue signal isolating amplifiers prevent this form of measuring signal corruption and influence.

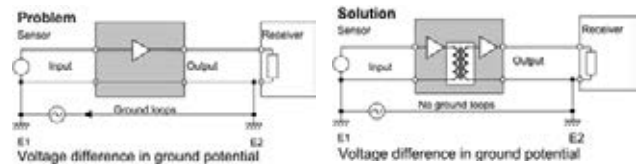

2-port Isolation

- The simplest form of analogue signal isolator is that of 2-port isolation. It serves to isolate the input circuit from the output circuit as well as the two auxiliary voltages from each other. Depending upon the isolator design and the observed isolation data one refers here to base isolation (galvanic isolation) or safe separation. ① For current signals, 4...20 mA input current loop fed modules are available. An additional auxiliary voltage for the input circuit is not required here. ② By connecting the input and output side voltage supplies, the 2-port isolation can be converted to operate as a simple signal converter. This is of particular interest where isolation is not required for an application, but a signal conversion has to be performed.



3-port Isolation

- 3-port isolation is the most universal form of signal isolator
- An optical coupler or transformer isolates the input from the output circuit. Together with the clearance and creepage distances it serves to define the isolation level. For example, the input signal is converted by means of pulse-width modulation into a frequency signal and demodulated again on the output side to form an analogue value. An amplifier then generates a standardised analogue signal. A galvanic isolated DC/DC converter feeds the input and output circuit with a potential free supply voltage. It also determines the isolation level through its data, air and creepage distances. In the case of these three isolation paths (input/output, input/auxiliary voltage, output/auxiliary voltage) one refers to 3-port isolation.

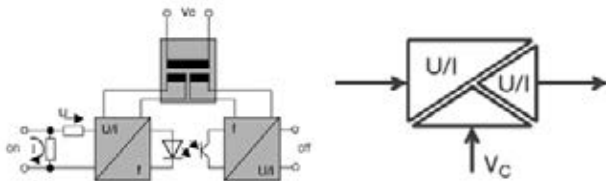

Temperature Signal Measuring Method

- Measurement using resistors (RTD)
When measuring with temperature-dependent resistors a current of approx. 1.5 mA is passed through the resistor from a constant current source in the signal converter.

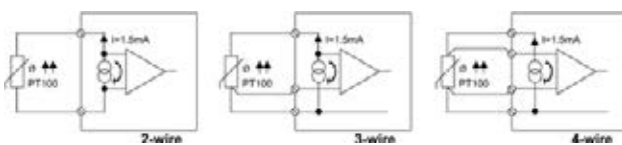

An operational amplifier is used to measure the potential drop at the resistor (2-wire circuit).

In order to take account of lead length, the voltage drop is measured at the return conductor and calculated with double the value (3-wire circuit). This simulates the wire resistances from the feed and return lines.

Accurate measurements are achieved by separately measuring the voltage drop at the feed and return lines (4-wire circuit). The values for the supply lines are calculated against the measured value.

Temperature Signal Measuring Method

- Measurements using thermocouples
When conducting measurements using thermocouples the voltage that is generated when two differently alloyed metals come into contact with each other is measured. A differential amplifier is then used to recondition the signal. The easiest (and the most cost-effective) method of subsequent processing is conducted by means of an amplifier circuit, which converts these signals into standard signals. High-end components process the measuring signal using a microprocessor, which simultaneously reconditions the signal (filtering, linearisation)

Cold Junction Compensation For Thermocouples

- Recording temperatures by using thermocouples encounters the problem of a thermal voltage forming at the clamping terminals on the signal converter on account of the different materials in the conductors and bus bar. This voltage then counteracts the thermal element's voltage.

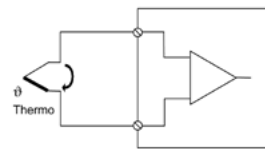

In order to compensate for the error to the measured value which arises here, the temperature is measured at the clamping terminal. The microprocessor in the signal converter reads the value measured there and calculates it against the measured value. This procedure is known as cold junction compensation.

$$\frac{\text{Voltage at the measuring point } (V_{\text{meas}}) + \text{Voltage at the terminal } (V_{\text{terminal}})}{\text{Voltage at the thermocouple } (V_{\text{thermo}})} \Rightarrow \text{Temperature at the thermocouple } (T_{\text{thermo}})$$

Linearisation

- Temperature-dependent components do not normally have linear characteristic curves. To ensure that further processing can take place with the necessary accuracy, these characteristic curves have to be linearised to some extent. The graph showing measurements of thermocouples, in particular, reveals significant deviations at some points from the "ideal graph". As a consequence, the signal which has been measured is worked up by microprocessor.

Technical data

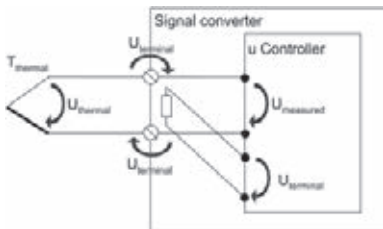

The microprocessor compares the value measured with the characteristic curve for the thermocouple in its memory and calculates the corresponding value on the "ideal characteristic curve". At the output, it supplies the latter to an amplifier, which produces the analogue value in linear form. The output stage converts this into a standardised value or into a switching output with a switching threshold.

The linearisation of PT100-elements can be undertaken via simple amplifier stages. The first stage corrects the peak value of the graph of the measurements. The deviation at the end of the graph resulting from this is corrected by a second stage. The under- and overshooting generated in this way is very slight and is covered by the tolerance for the module.

Current Measurement Using A Measuring Transformer

- Transformer principle: Each conductor through which current flows is surrounded by a magnetic field H, the intensity of which is proportional to the current. The field, which is bundled in a magnetic core, generates a magnetic flux B, through which suitable sensors are used to measure current.

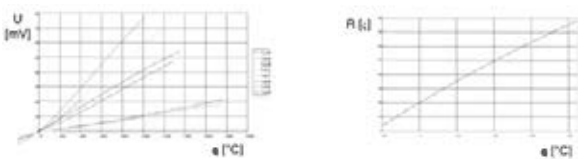

Converters with transformer-type couplings are used to establish the most cost effective measurement method for simple sinusoidal currents. The current to be measured flows directly through the measuring transformer's primary winding.

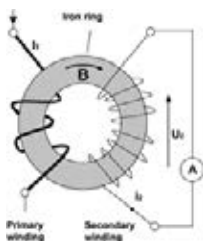

The secondary winding supplies the measuring electronics with a proportional current signal. Because of power loss this method of measuring current is limited to smaller currents up to 5 A. These converters react sensitively to peak loads and therefore have to be fused on the primary winding side.

Measuring Current Using A Hall-type Sensor

- Hall-type sensor principle: Hall-type sensors also measure the magnetic flux B and supply a proportional voltage at the measured output, which is then reconditioned to form a standard signal by an amplifier circuit.
- Components with Hall-type sensors are ideally suited to measuring higher currents, as any possible high residual currents from motors or peak loads cannot damage the component. Additionally, they are also ideal for measuring direct and alternating currents of various curve shapes.

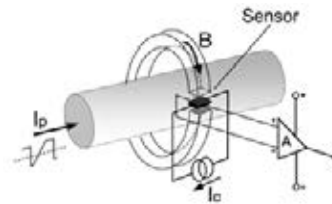

Root Mean Square Measurement / Crest Factor

- The root mean square value (r.m.s) of a sinusoidal shaped alternating current is the value, which in an ohmic resistor converts the same (effective) output as that of an equal sized direct current.
- Non sinusoidal shaped signals can only be measured with "True RMS" capable devices and/or further processed.
- True RMS = True root mean square
- Root mean square measurement is required where the (effective) output content of alternating voltages or currents are to be measured or evaluated.
- The crest factor indicates the ratio of the crest factor to the root mean square value.

W

Load / Load Resistor

- The load is a load resistor on the output side of a measuring transducer or isolating amplifier. The load is usually less than 500 Ω at the current outputs. Voltage outputs are normally under a load greater than 1 KΩ.

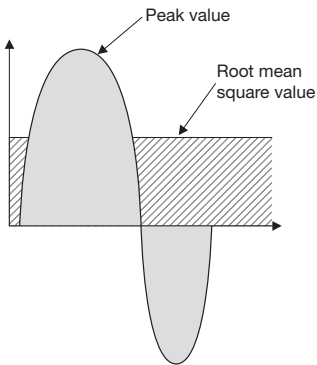

Galvanic Isolation / Safe Separation

- Galvanic isolation is understood to mean an electrical isolation between the input and output circuit and the circuit's supply voltage. It can be set up either optically using an opto coupler or with a transformer. The isolation serves to safeguard the measuring circuit against damage and to eliminate ground loops, which could cause the measured signal to be corrupted.
- Safe separation is specified under the German DIN VDE 0106 Section 101 standard. This fundamental safety standard is intended to safeguard persons against hazardous body currents and describes the basic requirements for safe separation in electrical operating equipment. Thus, for instance, the voltage supply of 50 V AC/ 75 V DC as under 50178 may not be exceeded. If this voltage is exceeded a reinforced or double insulated and thus an increase in the clearance and creepage distances is stipulated.

Cut-off Frequency

- Cut-off frequencies indicate the dynamic transfer characteristic of an isolation amplifier.
- The given frequency is the (-3dB-) limit, at which a distinct change occurs to the signal.
- An increased cut-off frequency leads to a transmission of higher-frequency alternating components, which corrupts the required signal.

Hysteresis

- Hysteresis indicates the percentage difference between the input and output points of a switching contact. It should not be lower than a given minimum value, as otherwise a specified chase can no longer be implemented.

Broken-wire Detection

- When measuring transformers with broken wire detection the input signal is monitored permanently. In the event of a fault (broken wire) the output signal exceeds its rated range. The downstream control circuit can then analyse the fault case.

Response Time

- Response time refers to the change in output signal for an input signal jump (10 ... 90 %). It is directly related to the cut-off frequency (inversely proportional).

Accuracy / Temperature Coefficient

- Accuracy describes the capability of a measuring device to deliver a measured value as accurately as possible. It relates to the end value and is given for ambient temperature (23 °C). Example:
An RTD is given with an accuracy of 1 %. The measuring range is set to 0 – 200 °C. The expected effective error of: $200 \cdot 1 \% = \pm 2K$ applies across the entire measurement range.
- Temperature coefficient describes the deviations in accuracy of the measuring devices dependent on the ambient temperature. It is given as a % or in parts per million / Kelvin (ppm /K).
Example:
An RTD with an accuracy of 1 % and a measuring range of 0 – 200 °C has a temperature coefficient of 250 ppm / K. If the device is operated at +40 °C, it will then contribute the following to an expected absolute error: $(([40 \text{ °C} - 23 \text{ °C}] \cdot 250 \text{ ppm/K}) + 1 \%) \cdot 200K = \pm 2,85K$ across the entire measurement range.



FDT/DTM – The standard solution for device configuration

Field Device Tool (FDT)

FDT technology specifies and standardises the integration of communicating devices from different manufacturers. It makes use of a superimposed device management program. The key feature is its independence from the communication protocol and software used by the device and the host system. FDT allows access to any device from any host using any protocol.

Device Type Manager (DTM)

Device manufacturers make available a Device Type Manager (DTM) software driver for each device or device group. The DTM specifies all device-specific information, functions and rules (such as the device structure, communication capabilities, internal dependencies and the human-machine interface (HMI)). DTMs define functions for access to device parameters, troubleshooting, configuration and operation of devices. DTMs are available which can be simple GUIs for setting device parameters or more complex applications that are capable of carrying out calculations for diagnostic or maintenance purposes.

There are several different types of DTMs:

- **Device DTM**
This is a “normal” field device that uses communication channels to communicate with the connected physical device.
- **Communication DTM**
This is a communications device that provides communication using communication channels. Communication channels provide access to the communications infrastructure (such as PC interface cards or modems). They are used by device DTMs or gateway DTMs for communication services.
- **Gateway DTM**
This is a gateway device. It allows data to be exchanged between two communication channels. For example, this could be a gateway between PROFIBUS-DP and PROFIBUS-PA.

The DTM is loaded and started up within a FDT container program or “frame” application.



FDT frame application

Frame applications can be used as a tool to configure devices, plan projects, operate consoles or administer facilities. The FDT frame application provides a PC software environment with the following functions:

- User administration
- DTM administration
- Data management
- Network configuration
- Navigation

Weidmüller offers their WI-Manager FDT frame program to the user for no cost. This certified software is compatible and works together with all certified DTMs. This screenshot shows the WI-Manager with an opened DTM for the ACT20X series.

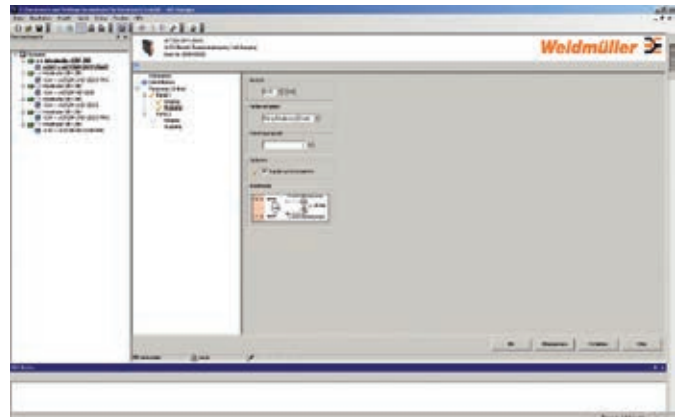

Download at www.weidmueller.com/



FDT User Group

The FDT User Group is an alliance of users and manufacturers interested in defining the specifications and moving the FDT/DTM technology forward. Weidmüller is a member of this group along with most process automation manufacturers and work towards advancing this standard further.

More details are available at <http://www.fdtgroup.org/>

Safety in hazardous areas

When operating electrical devices within hazardous areas, you must comply with the requirements regulating their use in such zones. Explosive atmospheres may be created from mixtures of flammable gases, mists, vapours or dusts. If their concentration is high enough in the surrounding air, any source of ignition or spark could trigger an explosion. Such explosions can cause death, serious injuries and significant property damages.

There are basically two strategies for reducing the risk of explosion. Firstly, no dangerous materials should be released into the air that could create an explosive atmosphere.

Secondly, there should be no mechanism present that could create a spark.

Many explosions in the past could have been avoided if only the international regulation governing the use of equipment in hazardous areas had been observed.

But what are the most important global regulations regarding the use of devices in hazardous areas?

In North America, the US National Electric Code (NEC) regulations (Articles 500 to 505 and the Canadian CEC (Canadian Electrical Code) Articles 18-000, -090, -100, -200 and -300 are all valid.

In Europe, both EU directives ATEX 95 (94/9/EG) and ATEX 137 (1992/92/EC) are relevant. They describe preparation (ATEX 95) and usage (ATEX 137) for facilities in potential Ex zones. Throughout the rest of the world, there is a mixture of national regulations (in Eastern Europe) and international IECEx conformity declarations (in Asia) that must be followed. In certain Asian countries, the European ATEX directives have been accepted and applied.

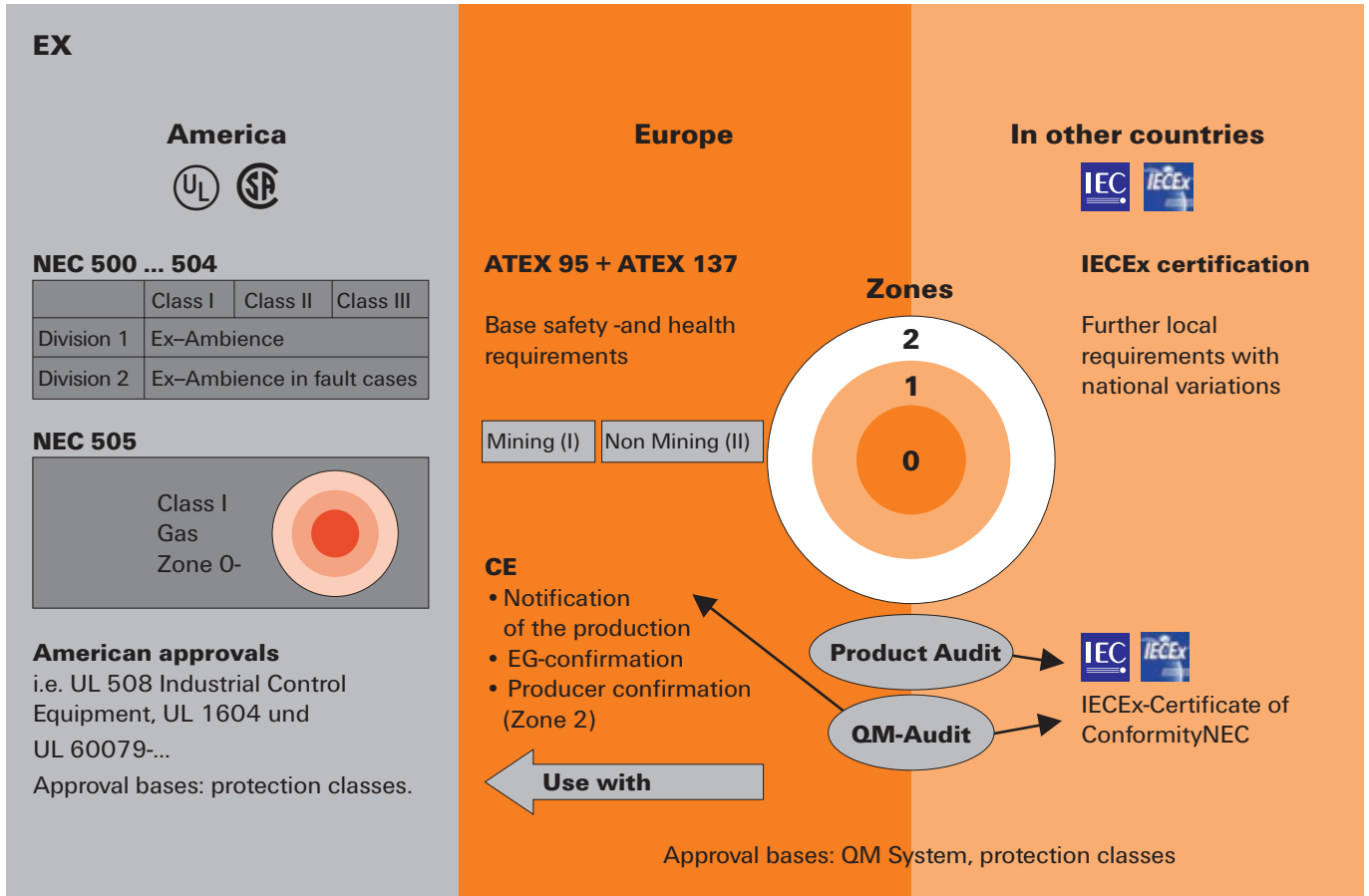

A brief overview of regulations used throughout the world and their basic content.

The European ATEX Regulation applies to facilities and their usage in hazardous areas.

The term "ATEX" derives from the French phrase "Atmospheres Explosive". The regulation currently includes two directives from the European Union concerning explosion protection. These are the ATEX operational directive 1999/92/EG (ATEX 137) and the ATEX product directive 94/9/EG (ATEX 95). The ATEX 137 operational directive specifies the minimum requirements for improving the protection of health and security of workers in environments at risk of explosions. The ATEX 95 product directive specifies the rules for introducing products on the market that will be used in zones where there is risk of explosion. This directive is the first to include non-electric devices within its jurisdiction.

The purpose of the directive is to protect personnel who work in hazardous areas. Appendix II of the directive contains the basic health and safety requirements. These must be followed by the manufacturer and compliance must be proven by declarations of conformity. Since June 30, 2003, all devices, components and protective systems brought to the market must be in compliance with the ATEX 95 product directive.

The ATEX 95 directive classifies devices and components for the Ex zone into two main groups:

Group I

=> Devices for use in mining, for underground and above-ground operations

- Coal dust
- Methane
- Harsh operating conditions

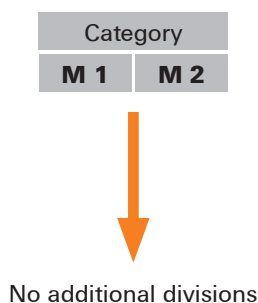

Group II

=> Devices for use in the other hazardous areas

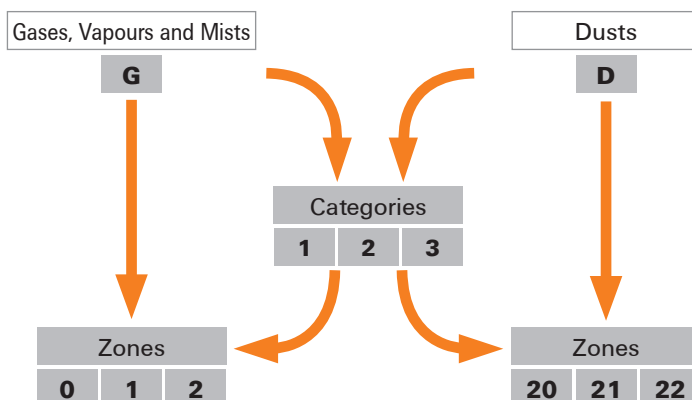

For applications in the oil, gas and chemical industries, it is particularly important to follow the Group-II "G" requirements concerning electrical or electronic devices and components.

W

Safety in hazardous areas

Group II "G" divides the Ex zone into three zones with different safety requirements.

- Zone 0** This zone applies to dangerous explosive atmospheres where the risk is present often or over long time periods.
 => > 50 % of the operational time, or more than 1.000 hours per year.
- Zone 1** This zone applies to situation where explosive atmospheres may occasionally be present during normal operations.
 => Occasionally, less than 10 hours per year.
- Zone 2** This zone applies to situation where explosive atmospheres are normally not present or only briefly present during normal operations.
 => Max. 30 min/year.

Hazardous areas

	Zone 0	Zone 1	Zone 2	Safe zone
Explosion risk	Continual, long-term, often	Occasionally	Rarely	None
Spark source	None	Rarely and short-term	Occasionally	Continual, long-term, often

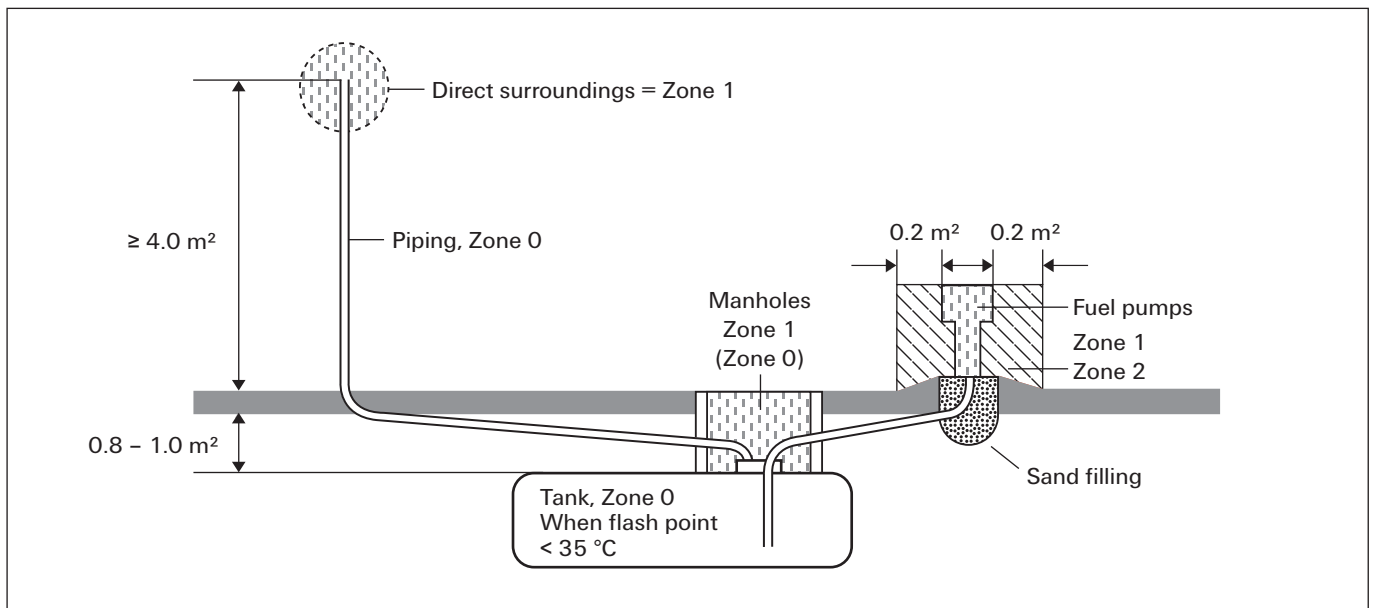

Typical division of zones at a fuelling station

W

In which operations are ATEX-certified electronic devices (such as signal converters, isolation amplifier, Namur switches and switching amplifiers) used?

ATEX-certified devices are used within industrial facilities and production halls where there is the possibility that explosive gases or dusts may be released.

Transportation and production applications which require the use of such certified devices are listed below:

- Off-shore oil and gas drilling
- Tanker ships which carry oil, gas or chemicals
- Ships which carry potentially explosive materials
- Refineries and other oil or gas production plants
- Transportation and filling stations for oil and gas
- Petro-chemicals

What are the differences between standard devices and intrinsically safe devices?

For electronic devices that are being used in Zone 0(20) or 1(21), none of the components or electrical circuitry are permitted to generate unallowable high temperatures or sparks, whether during normal operations or during malfunctions. In other words: "All of the circuits in intrinsically safe electrical devices (Ex i) are safe and are not capable of igniting explosive atmospheres".

What is the device category?

The device Group II (hazardous areas not including underground or above-ground mining operations) is divided into device categories 1, 2 and 3. They have the following safety levels:

Surroundings	Device category	Occurrence and duration of explosive atmosphere	Ignitable materials	Safety levels Permitted errors	Groups and zones Comparison
Group II	1	Constantly occurring Long-term Regularly	Gases, vapours, mist, dust	Very high safety level 2 different protection classes or 2 independent errors	Group II Zone 0 (gas) Zone 20 (dust)
Group II	2	Occurrence probable over a limited time period	Gases, vapours, mist, dust	High safety level 1 protection class For which no more than one error may occur	Gruppe II Zone 1 (gas) Zone 21 (dust)
Group II	3	Occurrence improbable Only for short periods	Gases, vapours, mist, dust	Normal I safety level Required protective measures	Group II Zone 2 (gas) Zone 22 (dust)

Safety in hazardous areas

Which explosion protection categories are most commonly used?

- **Pressure-resistant encapsulation (Ex d) in compliance with EN60079-1:**

Components that are capable of triggering an explosion are enclosed in a housing that is capable of withstanding the explosion. Openings in the housing are designed to prevent the explosion from being transmitted externally.

- **Increased safety (Ex e) in compliance with EN60079-1:**

This explosion protection category is normally applied to transformers, motors, batteries, terminal blocks, electrical lines and cables. It is not suitable for the protection of electronic components and spark-generating components (such as switches, relays or surge protection). Additional measures and an increased safety level are implemented in order to prevent any sparks, electrical arcing or unallowable high temperatures which could trigger ignitions. Increased safety is made possible by housing that prevents dusts from penetrating within.

- **Explosion protection methods (Ex n):**

This explosion protection category may only be used in the hazardous areas 2/22. Here there is no danger of an explosion from the electrical equipment during normal operations or during defined malfunctions. This includes all electrical devices and components that have no spark-forming contacts and that have a water-proof or dust-proof housing. Larger creepage and clearance distances are not required as long as the maximum rated voltage of 60 V AC / 70 V DC is maintained.

- **Intrinsic safety (Ex i) in compliance with EN60079-11:**

Power supply to electrical equipment is carried out through a safety barrier which functions to limit the current and voltage so that the minimum power and temperature levels for creating an explosive mixture are not reached. Intrinsic safety for electrical and electronic devices is specified so that their circulating or stored power (even in event of malfunction) is never strong enough to trigger an explosion in an explosive atmosphere. You must also remember that not only the electrical device but also all other components connected to the circuit may be exposed to the explosive atmosphere. All switching circuits in intrinsically safe devices must be designed so that they are also intrinsically safe.

These devices are divided into the category groups <ia> and <ib> which differ in the number of occurring malfunctions.

Category <ia>

=> Switching circuits within category <ia> electrical devices must not be able to cause a spark even if two independent malfunctions take place.

Category <ib>

=> Switching circuits in electrical devices must not be able to cause a spark when a malfunction.

Electrical devices for use in explosive gas, vapour and mist atmospheres – in accordance with CENELEC

Explosion protection type	Identification	Protective design
Pressure-resistant encapsulation	Ex d	Encloses the explosion and prevents fire from spreading
Increased safety	Ex e	No spark formation or hot surfaces
Method of explosion protection	Ex n	No spark formation or hot surfaces
Intrinsic safety	Ex i	Limited energy for preventing spark formation or overheated surface temperatures

CENELEC classification of gases, dusts and the maximum permitted surface temperatures of devices and components

Gas group	Temperature classes					
	T1	T2	T3	T4	T5	T6
I	Methane	-	-	-	-	-
IIA	Ammonia	Ethyl alcohol	Benzene, Kerosene	Acetaldehyde	-	-
	Methane	Cyclohexane				
	Ethane	n-Butane				
	Propane	n-Hexane				
IIB	Lighting gases, Acrylonitrile	Ethylene, Ethylene oxide	Ethylene glycol, Hydrogen sulphide	Ethyl ether	-	-
	IIC	Hydrogen	Ethine (Acetylen)	-	-	Hydrocarbons

IEC (group II) Classification	Max. surface temperature	Comment
T1	450 °C (842 °F)	The temperature is relevant to all parts of the devices that can come into contact with potentially explosive materials.
T2	300 °C (572 °F)	
T3	200 °C (392 °F)	
T4	135 °C (275 °F)	
T5	100 °C (212 °F)	
T6	85 °C (185 °F)	
Tx	Max. surface temperature undefined	Valid for the closed tank systems used on container ships where the individual contents cannot be monitored in event of a fire. It is the responsibility of the operator to assess each temperature class.

What labelling is considered proper?

An example of device labelling:

CE 0539		II	2	G	Ex ia	IIA	T4
↓	↓	↓	↓	↓	↓	↓	↓
Certification authority ex. DEMKO	European Commission mark for Ex devices	Device group "Surface"	Device category zone 1	Gas	Protection explosion type: intrinsically safe category <ia>	Gas group	Surface temperature: max 135 °C

ATEX directives

Since July 1, 2003, all new facilities in hazardous areas must be certified according to ATEX Directive 94/9/EG or ATEX 95 (ATEX: ATmosphère EXplosive = explosive atmosphere). This directive is one of the “New-Approach” directives. It is valid in all European Union countries, as well as Iceland, Lichtenstein and Norway. In these countries, the directive refers to the sale and commissioning of products which have been designed particularly for high explosion risk environments (where explosive atmospheres exist due to gases, vapours, mists, or dusts). It now also covers the mining sector and purely mechanical devices.

Class of protection

Type of protection	Code	CENELEC EN	IEC	Product category explosion protect.
General requirements	-	60079-0	60079-0	-
Oil immersion	o	60079-6	60079-6	2
Pressurised apparatus	p	60079-2	60079-2	2
Powder filling	q	60079-5	60079-5	2
Flameproof enclosure	d	60079-1	60079-1	2
Increased safety	e	60079-7	60079-7	2
Intrinsic safety	ia	60079-11	60079-11	1
Intrinsic safety	ib	60079-11	60079-11	2
Intrinsic safety	ic	60079-11	60079-11	3
Typ n (Ex n)	n	60079-15	60079-15	3
Encapsulation	m	60079-18	60079-18	2

Classification for potentially hazardous areas

CENELEC classification IEC60079-10	Presence of potentially explosive atmosphere	Product-category	US classification NEC 500	Combustible media
Zone 0	permanent, long-term	1G	Class I, Div 1	gases, vapours
Zone 20	or frequently	1D	Class II, Div 1	dust
Zone 1	occasionally	2G	Class I, Div 1	gases, vapours
Zone 20		2D	Class II, Div 1	dust
Zone 2	rarely and	3G	Class I, Div 2	gases, vapours
Zone 22	briefly	3D	Class II, Div 2	dust

Explosion groups

Gas (e.g.)	CENELEC	NEC 500
Propane	IIA	D
Ethylene	IIB	C
Hydrogen	IIC	B
Acetylene	IIC	A
Methane (mining)	I	mining (MSHA)

Temperature classes

Max. surface temperatur (°C)	Temperature class CENELEC	Temperature class NEC 500-3
450	T1	T1
300	T2	T2
280	-	T2A
260	-	T2B
230	-	T2C
215	-	T2D
200	T3	T3
180	-	T3A
165	-	T3B
160	-	T3C
135	T4	T4
120	-	T4A
100	T5	T5
85	T6	T6

Labelling for ATEX approval of a signal converter

II 3 G Ex nAnCnL IIC T4

- II** = Device group 2: devices for use in hazardous areas (except for mines and above-ground mining facilities that are exposed to flammable dusts or methane)
- 3** = Device category 3: the danger occurs rarely or only for short periods. The requirement is for normal security, suitable for use in zone 2.
- G** = Intended for the gas zone
- Ex** = Explosion protection
- nA** = Non-sparking equipment
- nC** = Enclosed facility (suitable protection)
- nL** = Equipment with limited power
- IIC** = Explosion groups: typical gas for C is hydrogen
- T4** = Temperature class: The max. permitted surface temperature for T4 is 135 °C

Zone 2 a zone for which, during normal operations, there is at most, only a short-term occurrence of dangerous hazardous atmospheres (mixtures of air and flammables gases, vapours or mists).

II (1) G [Ex ia] IIC/IIB/IIA

- II** = Device group 2: devices for use in hazardous areas (except for mines and above-ground mining facilities that are exposed to flammable dusts or methane)
- (1)** = Device category (1): Equipment from category 1 can be connected to this signal converter. The signal converter must be operated in the safe zone or in zone 2 (II 3 G ...).
- G** = Intended for the gas zone.
- [Ex ia]** = Explosion protection type: protected with intrinsic safety. This signal converter, as accompanying equipment, is intended to be used for the connection of intrinsically safe circuits.
- IIC/IIB/IIA** = Explosion groups – typical gases: propane for A, Ethylene for B, and hydrogen for C.

II (1) D [Ex iaD]

- II** = Device group 2: devices for use in hazardous areas (except for mines and above-ground mining facilities that are exposed to flammable dusts or methane)
- (1)** = Device category (1): Equipment from category 1 can be connected to this signal converter. The signal converter must be operated in the safe zone or in zone 2 (II 3 G ...).
- D** = Designed for the dust zone.
- [Ex iaD]** = Explosion protection type: protected with intrinsic safety. This signal converter, as accompanying equipment, is intended to be used for the connection of intrinsically safe circuits.



Design of clearance and creepage distances in electrical equipment – influencing factors

Rated impulse withstand voltage

The rated impulse withstand voltage is derived from:

- **Voltage conductor – earth**
(the rated voltage of the network, taking into account all networks)
- **Surge category**

Table 1: Rated impulse withstand voltages for electrical equipment

Rated voltage of power supplies system *) in V		Rated impulse withstand voltage in kV			
Three-phase systems	Single-phase systems with neutral point	Electrical equipment at the supplies point of the installation (Surge category IV)	Electrical equipment as part of the permanent installation (Surge category III)	Electrical equipment to be connected to the permanent installation (Surge category II)	Specially protected electrical equipment (Surge category I)
	120 to 240	4.00	2.50	1.50	0.80
230/400					
277/480		6.00	4.00	2.50	1.50
400/690		8.00	6.00	4.00	2.50
1000		Values depend on the particular project of, if no values are available, the values of the preceding line apply.			

*) to IEC 38

Surge categories

are stipulated in accordance with the German standard DIN VDE 0110-1 (for electrical equipment fed directly from the low-voltage network).

Surge category I

- Equipment that is intended to be connected to the permanent electrical installation of a building. Measures to limit transient surges to the specific level are taken outside the equipment, either in the permanent installation or between the permanent installation and the equipment.

Surge category II

- Equipment to be connected to the permanent electrical installation of a building, e.g. household appliances, portable tools, etc.

Surge category III

- Equipment that is part of the permanent electrical installation and other equipment where a higher degree of availability is expected, e.g. distribution boards, circuit-breakers, wiring systems (including cables, busbars, junction boxes, switches, power sockets) in the permanent installation, and equipment for industrial use and some other equipment, e.g. stationary motors with permanent connections to the permanent installation.

Surge category IV

- Equipment for use at or near the power supplies in the electrical installations of buildings, between the principal distribution and the mains, e.g. electricity meters, circuit-breakers and centralised ripple controllers.

Pollution severity categories

Pollution severity category 1

- No pollution, or only dry, non-conductive pollution that has no influence.

Pollution severity category 2

- Non-conductive pollution only; occasional condensation may cause temporary conductivity.

Pollution severity category 3

- Conductive pollution, or dry, non-conductive pollution that is liable to be rendered conductive through condensation.

Pollution severity category 4

- Contamination results in constant conductivity, e.g. caused by conductive dust, rain or snow.

Unless explicitly stated otherwise, the measurement of clearance and creepage distances and the resulting rating data for electromechanical components is based on pollution severity 2 and surge category III, taking account of all network types.

Derating curve (current-carrying capacity curve)

The **derating curve** shows which currents may flow continuously and simultaneously via all possible connections when the component is subjected to various ambient temperatures below its upper limit temperature.

The **upper limit temperature** of a component is the rated value determined by the materials used. The total of the ambient temperature plus the temperature rise caused by the current load (power loss at volume resistance) may not exceed the upper limit temperature of the component, otherwise it will be damaged or even completely ruined.

The current-carrying capacity is hence not a constant value, but rather decreases as the component ambient temperature increases. Furthermore, the current-carrying capacity is influenced by the geometry of the component, the number of poles and the conductor(s) connected to it.

The current-carrying capacity is determined empirically according to DIN IEC 60512-3. To do this, the resulting component temperatures t_{b1} , t_{b2} and the ambient temperatures t_{u1} , t_{u2} are measured for three different currents I_1 , I_2 .

The values are entered on a graph with a system of linear coordinates to illustrate the relationships between the currents, the ambient temperatures and the temperature rise in the component.

Base curve

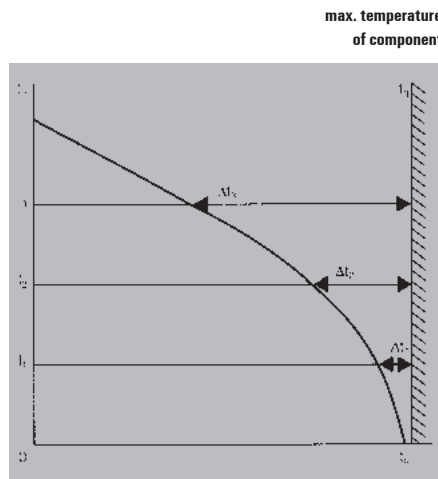

t_g = maximum temperature of component
 t_u = ambient temperature
 I_n = current

The **loading currents** are plotted on the y-axis, the **component ambient temperatures** on the x-axis.

A line drawn perpendicular to the x-axis at the upper limit temperature t_g of the component completes the system of coordinates.

The associated average values of the temperature rise in the component, $\Delta t_1 = t_{b1} - t_{u1}$, $\Delta t_2 = t_{b2} - t_{u2}$, are plotted for every current I_1 , I_2 to the left of the perpendicular line.

The points generated in this way are joined to form a roughly parabolic curve.

As it is practically impossible to choose components with the maximum permissible volume resistances for the measurements, the base curve must be reduced.

Derating curve

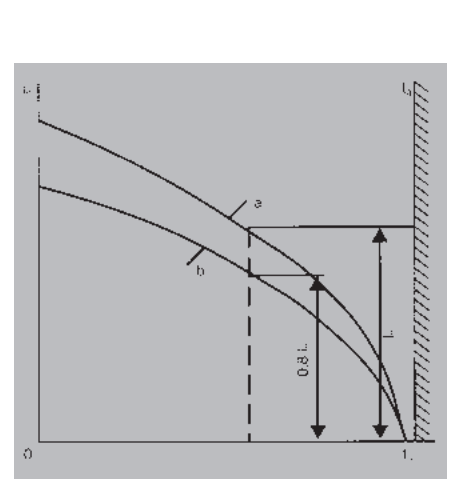

t_g = maximum temperature of component
 t_u = ambient temperature
 I_n = current
 a = base curve
 b = reduced base curve (derating curve)





Reducing the currents to 80 % results in the **"derating curve"** in which the maximum permissible volume resistances and the measuring uncertainties in the temperature measurements are taken into account in such a way that they are suitable for practical applications, as experience has shown. If the derating curve exceeds the currents in the low ambient temperature zone, which is given by the current-carrying capacity of the conductor cross-sections to be connected, then the derating curve should be limited to the smaller current in this zone.

IP class of protection to DIN EN 60529

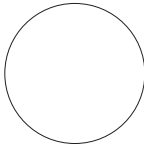

The class of protection is indicated by a code consisting of the two letters IP and two digits representing the class of protection.

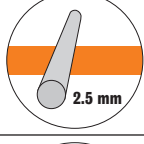
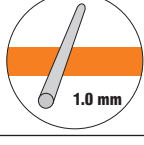
Example: **I P 6 5**
 | |
 2nd digit: protection from liquids
 1st digit: protection from solid bod

Protection against intrusion of external particle matter (1st digit)

Digit		
0		No protection
1		Protection against ingress of large solid bodies with diameter > 50 mm. (Protection to prevent dangerous parts being touched with the back of the hand.)
2		Protection against ingress of large solid bodies with diameter > 12.5 mm. (Protection to prevent dangerous parts being touched with the fingers.)
3		Protection against ingress of large solid bodies with diameter > 2.5 mm. (Protection to prevent dangerous parts being touched with a tool.)
4		Protection against ingress of large solid bodies with diameter > 1 mm. (Protection to prevent dangerous parts being touched with a piece of wire.)
5		Protection against harmful deposits of dust, which cannot enter in an amount sufficient to interfere with satisfactory operation.
6		Complete protection against ingress of dust.

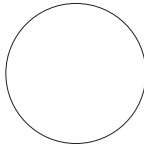
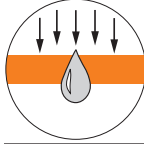
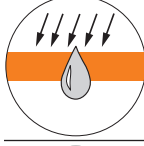
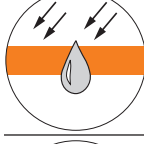
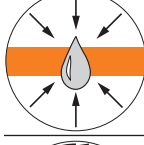
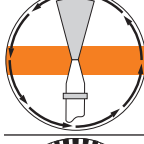
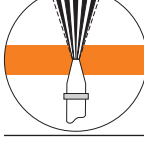
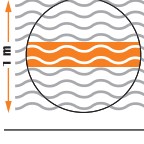
Protection against penetration of liquids (2nd digit)

Digit		
0		No protection
1		Protection against drops of condensed water falling vertically.
2		Protection against drops of liquid falling at an angle of 15° with respect to the vertical.
3		Protection against drops of liquid falling at an angle of 60° with respect to the vertical.
4		Protection against liquids splashed from any direction.
5		Protection against water jets projected by a nozzle from any direction.
6		Protection against water from heavy sea on ships' decks.
7		Protection against immersion in water under defined conditions of pressure and time.
8		Protection against indefinite immersion in water under defined conditions of pressure (which must be agreed between manufacturer and user and must be more adverse than number 7).

CE marking / EMC directives

Overview of CE labelling

The CE marking, seen on various products and their packaging, is neither a sign of quality nor safety. The CE marking is a conformity marking that was introduced to ensure the unhindered movement of goods throughout the Single European Market.

It is not intended to be a reference for end consumers. The CE marking merely shows that the manufacturer has complied with all the EU directives applicable to that product. Therefore, the CE marking should be regarded as verification of conformity with the relevant directives and is aimed at the monitoring authorities responsible. For goods crossing the political borders of the European Union, the CE marking is like a "passport". Weidmüller takes into account all the relevant EU directives according to the best of its knowledge and belief.

Currently the following directives apply:

2006/95/EG – Electrical equipment for use within specific voltage ranges (Low-voltage Directive)

2004/108/EG – Electromagnetic compatibility (EMC Directive)

2006/42/EG – Safety of machines (Machinery Directive)

The standards cited in the directives have long since been intrinsic to Weidmüller's development standards. This provides the guarantee of conformity with the EU directives. Our testing laboratory, accredited to EN 45001, performs the tests in accordance with the standards. The test reports are recognised within Europe within the framework of the accreditation process.

2006/95/EC Low Voltage Directive – Electrical equipment in this directive means all electrical equipment with a nominal voltage between 50 and 1000 V AC and between 75 and 1500 V DC. For an electrical product to be given the CE marking, it must fulfil the requirements of the EMC Directive and, if applicable, the Low-voltage Directive (50 V AC or 75 V DC). According to the Low-voltage Directive, a conformity assessment procedure has to be carried out for the product. Conformity with the directive is deemed to be given if there is a reference to a harmonised European standard or another "technical specification", e.g. IEC standards or national standards.

2004/108/EG EMC directives – With the decree of the directive of the European Council dated 3 May 1989 for the alignment of the legal requirements of the member states concerning „**Electromagnetic Compatibility**“, the European Union has declared **EMC** as a protection objective. The former EMC directive 89/336/EWG was replaced on December 31, 2004 by the revised version 2004/108/EG which has been valid since July 20, 2009.

CE marking / EMC directives

The safety goals are defined in Article 5 of the EMC regulation of December, 31 2004. They state the following:

- The electromagnetic disturbance generated must not exceed a level allowing radio and telecommunications equipment and other apparatus to operate as intended.
- The apparatus has an adequate level of intrinsic immunity to electromagnetic disturbance to enable it to operate as intended.

Apparatus is defined in the EMC Directive as follows:

- All electrical and electronic appliances together with equipment and installations containing electrical and/or electronic components.

This applies to the active/passive components and intelligent modules produced and stocked by Weidmüller. Compliance with this directive is deemed to be given for apparatus that conforms with the harmonised European standards that are published in, for example, in Germany, in the Gazette of the Federal Minister for Post and Telecommunications.

Such apparatus is utilised in the following areas:

- industrial installations,
- medical and scientific equipment and devices
- information technology devices.

Weidmüller tests its electronic products according to the relevant standards in order to fulfil the agreed protection objectives.

Electronic products from Weidmüller with respect to EMC directives

Category 1

All passive components such as:

- terminals with status displays
- fuse terminals with status indicators
- passive interface units with and without status indicators
- surge protection

These products cause no interference and they have a suitable immunity to interference. These products are not labelled with the CE marking concerning the EMC Directive or the German EMC Act.

Category 2

These products are labelled with the CE marking after the conformity assessment procedure has been carried out which includes the reference to the harmonised European standards.

The following are harmonised standards:

EN 61000-6-3 – Generic Emission Standard – Part 1: residential, commercial and light industry

EN 61000-6-1 – Generic Immunity Standard – Part 1: residential, commercial and light industry

EN 61000-6-4 – Generic Emission Standard – Part 2: industrial environment

EN 61000-6-2 – Generic Immunity Standard – Part 2: industrial environment

EN 55011 – Industrial, scientific and medical (ISM) radio-frequency equipment – Radio disturbance characteristics – Limits and methods of measurement

EN 55022 – Information technology equipment – Radio disturbance characteristics – Limits and methods of measurement

EN 61000-3-2 – Electromagnetic compatibility (EMC) – Part 3-2: Limits for harmonic current emissions (equipment input current up to and including 16 A per phase).

EN 61000-3-3 – Electromagnetic compatibility (EMC) – Part 3-3: Limitation of voltage fluctuations and flicker in low-voltage supplies systems for equipment with rated current less than or equal to 16 A per phase and not subject to conditional connection

Use of Tests

Generic standards are always used when no specific product standard for the particular devices exist. The generic standards EN 61000-6-X are used as the basis for Weidmüller products.

Note:

The relevance of EN 61000-6-1 for certain products must be checked as well as and how far generic standards EN 61000-6-3 or EN 61000-6-2 were considered during testing. The environment phenomena and test interference levels are specified in the generic immunity standards. In addition, Weidmüller considers the assessment criteria A, B and C.

Extract from the generic standard EN 61000-6-2:

Criterion A

The equipment shall continue to operate as intended. No degradation of performance or loss of function is allowed below a minimum performance level as specified by the manufacturer, when the equipment is used as intended. In certain cases the nominal performance level can be replaced by a permissible loss of performance. If the minimal performance level or permissible loss of performance is not specified by the manufacturer, both of these specifications can be derived from the description of the product, the relevant documentation and from what the operator expects from the equipment during its intended operation.

Criterion B

The equipment shall continue to operate as intended after the test. No degradation of performance or loss of function is allowed below a minimum performance level as specified by the manufacturer, when the equipment is used as intended. In certain cases the minimal performance level can be replaced by a permissible loss of performance. During testing degradation of the performance level is permitted; however, changes to the specified operation mode or data loss are not permitted. If the minimal performance level or permissible loss of performance is not specified by the manufacturer, both of these specifications can be derived from the description of the product, the relevant documentation and from what the operator expects from the equipment during its intended operation.

Criterion C

Temporary loss of function is allowed, provided the loss of function is self-recoverable or can be restored by the operation of the controls.

Criterion B is most frequently specified in the generic standards and is used by Weidmüller.

Taking the example of a WAVEANALOG analogue coupler: During testing, the analogue coupler may convert values that lie outside the permissible tolerances. After testing, however, the values must lie within the given tolerances.

General installation instructions

In conformity with the performance level and criteria A and B, the products may and can be affected by external influences during a fault. However, the aim should be to suppress this as far as possible by means of an optimum installation.

Measures

- Install the products in a metal enclosure (control cabinet, metal housing).
- Protect the voltage supplies with a surge protection device
- Use only shielded cables for analogue data signals.
- Apply ESD measures during installation, maintenance and operation.
- Maintain min. 200 mm clearance between electronic modules and sources of interference (e.g. inverters) or power lines.
- Ensure ambient temperature and relative humidity values do not exceed those specified.
- Protect long cables with surge protection devices.

For safety reasons, do not operate walkie-talkies and mobile telephones within a radius of 2 m of the equipment.

Glossary

1-9

2-way isolation	The input and output signals are separated electrically from each other and decoupled. Potential differences caused by long wire lengths and common reference points are eliminated.
3-way isolation	Also decouples the power supply to the input and output circuit and enables supply with only one operating voltage.

A

A/D converter	Converts standardised analogue current and voltage signals into an 8-bit, 12-bit or 16-bit digital signal. It may be necessary to convert analogue signals into digital signals when you need the analogue signal from the surroundings to work with the typical digital processing requirements of process monitoring.
AC	Alternating current
Accuracy	Describes the ability of an analogue signal isolating converter to transmit a measured value as precisely as possible. It is specified in the percent deviation from the measuring range end value at room temperature.
Active sensor	In an active sensor, an electrical signal is generated from the measurement itself, for example dynamometric or piezo-electric. Thus no auxiliary power source is required. Because of their physical operating principals (since energy cannot be sent during the static and quasi-static states), only a change in the measured variable can be detected.
Actuator	The actuator is a sensor counterpart – it converts electrical current into another form of energy.
Alarm contact	A switching contact that activates when a disturbance occurs (for example, an overload or short circuit).
Ambient temperature	DIN EN 60204-1 uses this term to refer to the temperature of the surrounding air or medium at which the equipment can be properly and safely operated. This is a part of the surrounding physical and operational conditions. Failure to maintain this temperature level can invalidate the product warranty.
Analogue signal	A signal is designated as an analogue signal if it transmits parameter information that is infinitely variable between a minimum and maximum value (this includes instantaneous values such as current, voltage or temperature). This applies to practically all real-world processes or states. It is theoretically possible to register any small signal changes (there is a very large dynamic range).

ATEX	<p>The ATEX directive from 23.4.1994 is valid within the EU and the EFTA Western European nations. It applies to devices, machinery components, controllers and protective systems that are to be used in hazardous areas. This directive harmonises the different national regulations from the EU member nations concerning the proper and intended use of machines and facilities in hazardous areas.</p> <p>ATEX is derived from the phrase “ATmosphere EXplosive”. It stipulates that operators should prevent explosions and ensure protection.</p> <p>Regarding explosion protection in a potentially explosive atmosphere, the ATEX directive 94/9/EC has precedence over machinery directives and must be followed. The directive describes the following steps:</p> <ul style="list-style-type: none"> • Describe how often a potentially explosive atmosphere occurs and where it occurs. • These areas are then divided into zones according to the specifications. • Make sure that only properly categorised equipment is present within each different zone. As soon as an area is classified as being dangerous, steps must be taken to limit the potential ignition sources that are present there.
-------------	--

C

Calibration device	A special instrument used for the calibration and configuration of analogue signal conditioning devices. The calibration device produces highly precise standardised signals. It is equipped with a load indicator for quick loop diagnostics.
CE	Abbreviation for C ommunauté E uropéenne (the European Community). Manufacturers use the CE label to confirm that their products comply with the corresponding EC directives and the “essential requirements” therein.
Cold-junction compensation	Thermocouples require a temperature reference point to compensate for unwanted “cold junctions”. The usual method for achieving this is by measuring the temperature at the reference junction with a temperature sensor that can be read immediately. The interfering voltage can then be compensated for in the measurement results. This process is referred to as cold-junction compensation (CJC).
Common-mode interference	Interfering currents and voltages that can occur on the connecting cables between electrical devices and facility components. These can then spread with similar phase and current direction to the feed line and the return line.
Counter	A counter can be used for measuring flow or for counting events. Analogue or digital input signals (pulses) may also be processed. Integrated function such as linearisation, interference suppression, hysteresis configuration and reference values expand the range of use of a counter. Switching contacts are available on the output side for monitoring threshold.

Creepage and clearance distances

The safety gaps between two current-carrying wires. The creepage distance is the shortest path along an insulating surface between two live components. The clearance distance is the shortest path in the air between two points of reference.

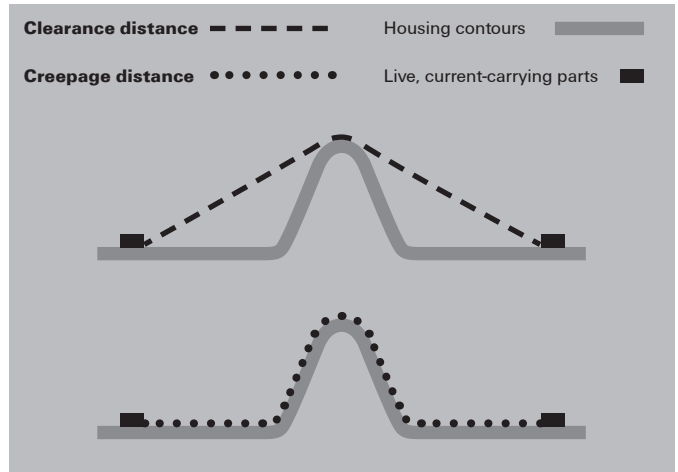

D

D/A converter

D/A converters convert standardised digital signals (for example, with an 8-bit structure) into analogue current and voltage signals. It may be necessary to convert digital signals into analogue signals when you need the analogue signal from the surroundings to work with the typical digital processing requirements of process monitoring.

DC

Direct current

Derating

The continuous current level reduction in relation to an ambient temperature increase, represented as a derating curve (a load reduction curve).

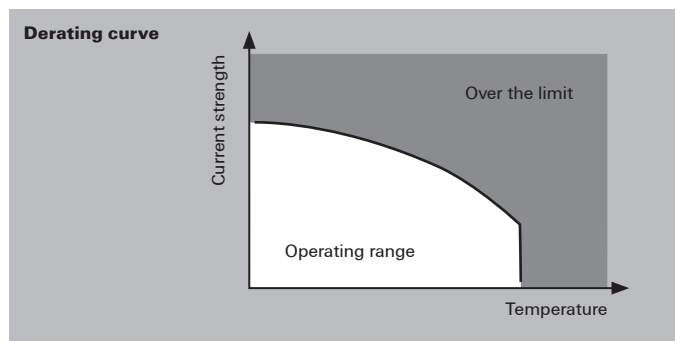

Device categories	The device category determines which equipment can be used in which zone. There are six device categories. The categories 1 G, 2 G and 3 G are classifications for gas explosion protection (G = Gas). Equipment with 1 G is suitable for zones 0, 1 and 2. Equipment with 2 G is suitable for zones 1 and 2. Equipment with 3 G is suitable for zone 2. The categories 1 D, 2 D and 3 D are classifications for dust explosion protection (D = Dust). Equipment with 1 D is suitable for zones 20, 21 and 22. Equipment with 2 D is suitable for zones 21 and 22. Equipment with 3 D is suitable for zone 22.
Device groups	Equipment is divided into groups I and II. Group I concerns underground mining while group II concerns explosion protection for gas and dust in all other applications.
DTM	DTMs (D evice T ype M anager) are software drivers that are vendor- and device-neutral. DTMs define functions for access to device parameters, troubleshooting, configuration and operation of devices The DTM specifies all device-specific information, functions and rules (such as the device structure, communication capabilities, internal dependencies and the human-machine interface (HMI)). Device manufacturers make available a Device Type Manager (DTM) software driver for each device or device group.

E

EIA-232/ RS232	The term EIA-232 (originally RS232) refers to a serial interface standard developed by a U.S. standards committee (now known as the EIA – Electronic Industries Alliance) in the early 1960s. EIA-232 specifies the connection between the data terminal equipment (DTE) and the modem (data communication equipment or DCE). It defines timing, voltage level, plug and protocol details. EIA-232 defines a voltage interface. The information bits are encoded using electrical voltage. The data lines (TxD and RxD) use a negative logic whereby a voltage level between -3 V and -15 V (ANSI/EIA/TIA-232-F-1997) represents a logical one and a voltage level between +3 V and +15 V represents a logical zero. Signal levels between -3 V and +3 V are undefined.
EIA-422/ RS422	EIA-422 (also known as RS422) is an interface standard for cable-based differential, serial data transmission. In contrast to the asymmetric serial interface specified by the EIA-232 standard, the EIA-422 interface is designed for symmetric transmissions. This means that two sets of twisted pair wires are required to carry the positive and negative signals from the sender to the receiver. This minimises common-mode interferences and also increases the data rates in comparison to the asymmetric EIA-232 interface. EIA-422 can be used to establish a full-duplex, point-to-point connection. Multi-drop networks with one sender and up to ten receivers are also possible. The sender and receiver in multi-drop networks can only be operated in half-duplex (in one direction). Because of the high data rate (up to several MBit/s), a wire pair on the EIA-422 interface must be terminated with a terminating resistor (normally 120 ohm).

EIA-485/ RS485	EIA-485, also referred to as RS485, is an interface standard for digital, cable-based, differential, serial data transmissions. EIA-485 uses a wire pair for transmitting inverted and non-inverted levels for a single-bit data signal. The original data signal is reconstructed by the receiver as the difference between the two voltage levels. This has the advantage of increasing the resistance to interference, since common-mode interference then has no effect on the transmission. The EIA-485 interface operates with a voltage differential of +/-200 mV, so that the voltage interface has a differential related to half of the operational voltage. It normally uses a single wire pair and is operated in half-duplex. However full-duplex operations are possible with two wire pairs. This connection has multi-point capabilities; up to 32 nodes can be connected to an EIA-485 bus. Standard cable lengths run up to 1.2 km in length and support transmission speeds up to 10 MBit/s. The wire pairs must be terminated with resistors (typically 120 Ohm) because of the cable length and high data rates.
Electrical equipment	All of the electrical and electronic components and circuits within an enclosure.
Explosion groups	Depending on the ignition protection, explosion-protected equipment intended for gases, vapours and mists are divided into three explosion groups (IIA-IIB-IIC). The explosion group provides a measure of the explosive break-through capability of gases (in an explosive atmosphere). The requirements for the equipment increase in strictness from II A to II C.
Explosion protection types	<p>The ignition protection type is a term used in explosion protection that refers to the various types of protective construction designed into the product. Ignition protection types are formulated to minimise the risk that an ignition source will be present in an explosive atmosphere.</p> <p>The following ignition protection types are specified:</p> <ul style="list-style-type: none"> • For electrical equipment in a gas <ul style="list-style-type: none"> • Intrinsic safety Ex i • Pressure-resistant Ex d encapsulation • Increased safety Ex e • Pressurization encapsulation Ex p • Oil immersion Ex o • Moulded encapsulation Ex m • Sand encapsulation Ex q • Ignition protection type for zone 2 Ex n • Special ignition protection type Ex s • For electrical equipment in dust <ul style="list-style-type: none"> • Pressurization encapsulation Ex pD • Intrinsic safety Ex iD • Moulded encapsulation Ex mD • Protection provided by housing Ex tD

Explosive atmospheres	This is defined as a mixture of flammable materials and oxygen. An ignition leads to a explosive burning process throughout the entire mixture. Usually the oxygen is supplied by the surrounding air. Flammable materials may be gases, liquids, vapours, mists or dusts. Explosion protection considers this to be normal atmospheric conditions. The explosiveness of the mixture depends of the flammability of the materials and the concentration of air or oxygen.
------------------------------	---

F

Flammability rating	Flammability class specification according to the American UL 94 specification. Duration of burning, annealing time and the burning drop formation are all taken into account. The highest category is V-0.
Frequency converter	Converts frequencies into analogue signals (or vice versa). In-line control systems can then directly process pulse strings from speed or rotational measurements.

G

Galvanic isolation	Potential-free isolation between electrical components. Normally, the inputs circuit, output circuit and power supply are designed so that they are electrically isolated from each other. The isolation can be achieved using optical means (an optocoupler) or by using a transformer. The electrical isolation of measurement signals ensures that the differences in earth potentials and common-mode interference are suppressed
GOST-R	The Russian certification for products, materials and technical facilities.

H

Hall sensor current measurement	Hall sensors can measure the magnetic field of a conducting wire. They then generate a proportional voltage on the measurement output (the Hall voltage). This can be converted to a standardised signal by means of an amplifier circuit. Such a measurement is well suited for measuring high DC and AC currents with frequencies up to 1 kHz. Start-up currents and current peaks cannot damage a Hall sensor.
--	---

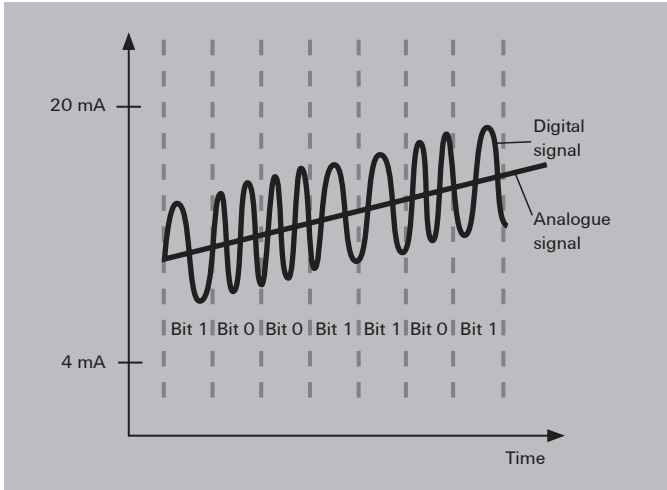
HART®	<p>HART® (Highway Addressable Remote Transducer) is a communications protocol for bus-addressed field devices used in process automation. In HART®-based communications, field devices and controllers are connected together over 4–20 mA current loops. This analogue signal is superimposed with a digital signal by using the FSK process (Frequency Shift Keying). The process allows additional measurements, configuration and device data to be transmitted without influencing the analogue signal. Ex isolators can also be used in hazardous areas.</p> 
Hazardous area	<p>According to the ATEX directive, an hazardous area is where the extent of the explosive atmosphere mandates that extra measures must be taken to safeguard health and protect surrounding machinery. Hazardous areas are classified according to the frequency and duration of the occurrence of the explosive atmosphere (refer to the sub-divided zones).</p>
Hysteresis	<p>Specifies the percent difference between the switch-on and switch-off points of a switching contact. The hysteresis must not fall below a minimal value. Otherwise it would no longer be possible to carry out specific switching during the monitoring of threshold.</p>
I	
IECEx	<p>An international directive regarding the creation of declarations of conformity by the manufacturers of facilities, devices and components that are intended for use in explosion risk zones. This directive is valid throughout the globe but is only currently used in some Asian nations.</p>
Impulse withstand voltage	<p>The high pulse voltage of a specified form and polarity that does not lead to an insulation breakthrough or flashover, under the specific conditions defined in EN 60664-1.</p>

Initiator PNP/NPN switched	Two wires in a three-wire sensor are responsible for keeping the supply activated. The third connecting wire is used for transferring commands (NO/NC contact). Initiators with NPN outputs switch the load in active mode towards the minus potential. Proximity switches with PNP outputs switch toward the plus potential.
Insulation voltage	For electronics components with electrical isolation, this is the maximum AC test voltage that can be applied for a specified time interval (5 s / 60 s) without causing a break-through.
Intrinsic safety "i"	Electrical equipment for hazardous areas with the ignition protection type "Intrinsic safety Ex i" Intrinsic safety is divided into ignition protection types "ia" or "ib" The ignition protection type "intrinsic safety" is a protective strategy that requires a complex analysis of electronic devices. So it is not only important to protect intrinsically safe current from the other unsafe circuits. It is also important to limit the open-circuit voltage, short-circuit current, power, stored energy and the surface temperature of components that will be exposed to the explosive atmosphere. Intrinsically safe circuits are circuits where a spark or thermal effect (as may occur under the testing conditions specified by EN 60079-11) is not capable of igniting an explosive atmosphere (of sub-groups IIA, IIB or IIC) or a dust-air mixture. The testing conditions cover normal operations and certain error conditions as specified in the standard.
IP protection classes	Equipment is assigned an IP protection class to indicate which environmental conditions it can be used in.
Isolation amplifier (active isolator)	An isolation amplifier is used to provide electrical isolation for analogue standard signals. They are designed with 2-way or 3-way isolation. The isolation of the potentials eliminates interference on the measurement signal that can be caused by earth loops or common-mode noise. The active isolator makes use of a separate voltage source for its power supply. It functions without feedback; a change on the output side load does not influence the input circuit.

L

Leakage current	The current on the load side of an optocoupler that flows towards the output circuit while in a closed state.
Limiting frequency	The limiting frequency of an analogue signal isolating converter is that frequency where the output signal is reduced to $1/\sqrt{2}$ of the value of the input signal (approx. 70.7 % = -3 dB).
Line break monitoring	Analogue measuring transducer with wire-break detection capability that permanently monitors the input signal. In the event of a fault (a wire break), the output signal jumps up to a defined value over the nominal range so that a controller wired further down the circuit can evaluate the error.

Linearisation	Temperature-dependent components normally do not have a linear characteristic curve. Their characteristic curves must be linearised so that they can be evaluated as precisely as possible. The measurement curves of thermocouples and temperature-dependent resistors (NTC/ PTC), in particular, exhibit significant deviation from an "ideal curve". In the linearisation process, the measurement signal is processed by a microprocessor and an ideal characteristic curve is generated which can then be analysed or processed further.
Load cell	A load cell is a special type of force sensor used in weighing systems (i.e., with scales). They are calibrated in grams (g), kilograms (kg) or tons (t). Load cells usually have a spring mechanism used as a force sensor. The spring is a specially shaped piece of metal whose shape changes slightly when under the influence of weight. This elastic deformation is recorded by strain gauges and converted into an electrical signal. Weights can be recorded ranging from a few hundred grams to several thousand tons.
Load resistance (load)	This is the load resistance on the output side of a measuring transducer or transmitter. For analogue current outputs, the load is 500–600 ohms maximum. Voltage outputs normally have a load of at least 10 kOhm.

M

Measurement isolating transformer	Converts electric and non-electric input signals into standard analogue signals. At the same time it provides electrical isolation between the input and output (2-way isolation) or between the input, output and supply (3-way isolation). Measurement isolators are typically used to record temperatures (RTD, thermocouples) or for measuring current, voltage, power, frequency, resistance and conductivity.
Measuring bridge	Sensors based on Wheatstone bridge circuitry can capture force, pressure and torque. Relatively small length changes under 10 – 4 mm can be recorded using DMS strain gauges in the form of resistance changes. A typical application is for capturing measurements in load cells.

N

Namur sensor	NAMUR-compliant sensors (The standardization commission for measuring and control technology in the German chemical industry) operate with a load-independent current. They have four modes so that an analogue evaluative unit can detect a sensor malfunction. 1) Current of 0 mA => wire break, circuit is open 2) Current of approx. 20 % of the max. value => Sensor ready, activated 3) Current of approx. 60 % of the max. value => Sensor ready, not activated 4) Current at max. value => short circuit, max. current NAMUR sensors are suited for use in hazardous areas.
---------------------	--

NEC 500 – 505	The relevant directives for the classification of explosion protection in the USA. NEC 500 regulates the standard Ex classifications (class – division – model). The NEC 505 defines the zone model based on the European and IEC classifications.
----------------------	--

Nominal switching current – load side	The permitted load current of a relay contact or semiconductor contact when in continuous operations.
Nominal switching voltage – load side	The switching voltage that a relay contact or semiconductor contact uses in relation to its application.

O

Output-current loop-powered	Output loop powered 2-wire transmitters have a 4 – 20 mA output. The transmitter is supplied with power via the current loop on the output side. A typical loop consists of a regulated DC power supply, the 2-wire transmitter and a receiving device.
Overvoltage category	<p>The overvoltage categories are described in DIN EN 60664-1. The category dictates the insulation clearance gaps required. Category III is the default specification (EN 50178).</p> <ul style="list-style-type: none"> • Overvoltage category I Devices that are intended to be connected to the permanent electrical building installation. The measures for limiting transient surge voltages to the proper level are taken outside of the device. The protective mechanisms can either be in the permanent installation or between the permanent installation and the device. • Overvoltage category II Devices that are intended to be connected to the permanent electrical building installation (such household appliances or portable tools). • Overvoltage category III Devices that are a part of the permanent installation and other devices where a higher degree of availability is required. This includes the distributor panels, power switches, distribution systems (including cable, busbars, distributor boxes, switches and outlets) that are part of the permanent installation, devices intended for industrial use, and devices that are continually connected to the permanent installation (such as stationary motors). • Overvoltage category IV Devices that are intended to be used on or near the power feed in a building's electrical installation – ranging from the main distribution to the mains power system. This includes electrical meters, surge protection switches and ripple control equipment.

P

Passive isolator/ input loop powered	<p>Generates its power supply from the input signal (0/4–20 mA). The amount of current needed internally is so small that the measurement signal is not influenced. Transformers are used to provide the isolation between the input and the output.</p> <p>The advantages include: eliminates the influence of the mains power system, highly accurate, minimal signal delay, and minimal power used. Passive isolators do not function free from feedback; so a load change on the output circuit will automatically effect the input circuit as well.</p>
Passive sensor	<p>Contains passive components whose parameters can be changed by the measured variables. A primary electronic mechanism converts these parameters into electric signals. An auxiliary external power source is needed for the passive sensor. Passive sensors can be used to determine both static and semi-static measured variables. For this reason, the majority of sensors have a passive construction. Examples of this type include load cells and resistance thermometers.</p>
Pollution severity level	<p>The pollution severity level specifies the conditions of the immediate surroundings. It is defined in DIN EN 50178, Section 5.2.15.2. The pollution (contamination) severity level should be used to determine the required creepage distance for the insulation. Pollution degree 2 is the default specification.</p> <ul style="list-style-type: none"> • Pollution severity level 1 There is no contamination or only dry occurrences of non-conductive pollution. This pollution has no influence. • Pollution severity level 2 There is only non-conductive pollution. Temporary occurrences of conductivity caused by condensation may also occur. • Pollution severity level 3 Conductive pollution or dry, non-conductive pollution that can become conductive due to condensation is likely to occur. • Pollution severity level 4 The contamination leads to continual conductivity which can be caused by such contaminants as conductive dust, rain or snow.

R

Rated voltage	<p>Specified by the insulation coordination – the rated voltage is the voltage level at which the product can be safely operated, in relation to the corresponding pollution severity level and the surge voltage category.</p>
Relative humidity	<p>The relationship between the actual moisture and the maximum possible quantity of water in the air. Expressed as a percentage.</p>

W

RoHS	The EC directive 2002/95/EC – concerning the restriction of the use of certain hazardous substances in electrical and electronic equipment – regulates the use of hazardous materials within devices and components. This directive, and its various implementations into national laws, are referred to by the abbreviation RoHS (Restriction of Hazardous Substances).
RTD/ PT100/ 1000	<p>RTD sensors are temperature probes that operate based on the resistance changes which take in metal as the temperature changes. They are resistance thermometers based on PTC resistors. The electrical changes in resistance of a platinum wire or platinum film is often used for measuring temperatures ranging from -200 °C to 850 °C. The platinum temperature sensors are characterised by their nominal resistance R₀ at a temperature of 0 °C. The standard types include:</p> <ul style="list-style-type: none"> • PT100 (R₀= 100 Ohm) • PT1000 (R₀= 1 kOhm) <p>A two-wire, three-wire or four-wire electrical connection can be used to electrically connect the PT/RTD sensor to the evaluative electronics. A three-wire or four-wire method eliminates any errors caused by the inherent resistance of the sensor connecting wires.</p> <p>In the three-wire method, one end is equipped with two pigtail connectors. In the four-wire method, both ends are equipped with two pigtail connectors.</p>

S

Self-heating	Self-heating refers to the temperature increase in an operating device caused by the internal power loss.
Sensor	A sensor is a physical component capable of capturing certain physical or chemical properties (such as thermal radiation, temperature, humidity, pressure, noise, brightness or acceleration) as a measurement. It may also be able to analyse the quality of the composition of the material surroundings. These values are captured using physical or chemical phenomena and then converted into another form (usually electrical signals) so they can be post-processed.
Signal distributorsplitter	A signal isolator that accepts an analogue input signal and delivers at least two signals on the output side. This permits the signal to be transmitted to a PLC/DCS system and to a separate display. A signal multiplier is designed either as an active isolator with an external power feed or as an output loop powered version.
SIL	<p>Safety Integrity Level.</p> <p>The components must meet the requirements of IEC 61508 in order to reduce risk. This standard provides general requirements for avoiding and minimising device and equipment outages. It stipulates organization and technical requirements concerning device development and operation. Four safety levels are defined (from SIL1 for minimal risk to SIL4 for very high risk) for classifying facilities and risk-reduction measures. Risk-reduction measures must be more reliable when the classified risk level is higher.</p>
Status indicator	An LED that displays the operational status, such as operational (yellow), switching (green), and alarm/malfunction (red).
Step response time	This is the time delay in the output signal change when there is a signal jump ranging from 10 to 90 % on the input side. The step response time is inversely proportional to the limiting frequency
Storage temperature	The permitted ambient temperature, related to a specific relative humidity level, for which the product should be stored while in a current-free state.

Switching threshold	The switch-on or switch-off point.
----------------------------	------------------------------------

T

Temperature classes	<p>Explosion-protected equipment that is to be installed into the Ex zone is subdivided into six temperature classes (T1 to T6).</p> <p>These temperature classes define the maximum surface temperature permitted for the equipment. The definition is based on an ambient temperature of +40 °C. This temperature may not be exceeded on any part of the equipment at any point in time. In all cases, the maximum surface temperature must be lower than the ignition temperature of the surrounding medium. The requirements placed on the equipment become stricter from class T1 to T6.</p>
----------------------------	---

Temperature coefficient	<p>The temperature coefficient describes the relative change of a physical variable based on the temperature change relative to a reference temperature (room temperature). It directly influences the precision of an analogue signal converter. The coefficient is specified in ppm/K of the corresponding measuring range end value.</p>
--------------------------------	---

Thermocouple	<p>A thermocouple is a component made of two different materials which are connected to each other at one end. An electrical voltage is created (based on the principle of the Seebeck effect) along a wire that connects the unattached ends when there is a temperature differential.</p> <p>The juncture point and the unattached ends must have different temperatures for a voltage to be generated.</p>
---------------------	---

The following thermocouples are used for industrial applications:

Thermal pair	Short name	Type	Temperature range in °C
Nickel/Chrome-Nickel/Al	NiCr-Ni/Al	K	-200 ... +1372
Iron-constantan	Fe-CuNi	J	-200 ... +1200
Copper-constantan	Cu-CuNi	T	-200 ... +400
Nickel/Chrome constantan	NiCr-CuNi	E	-200 ... +1000
Platinum/10 % Rhodium-Platinum	Pt10Rh-Pt	S	-50 ... +1760
Platinum/13 % Rhodium-Platinum	Pt13Rh-Pt	R	-50 ... +1760
Nickel/Chrome-Nickel/Magnesium	NiCr-NiMg	N	-200 ... +1300
Platinum/30 % Rhodium - Platinum/6 % Rhodium	Pt30Rh - Pt6Rh	B	0 ... +1820

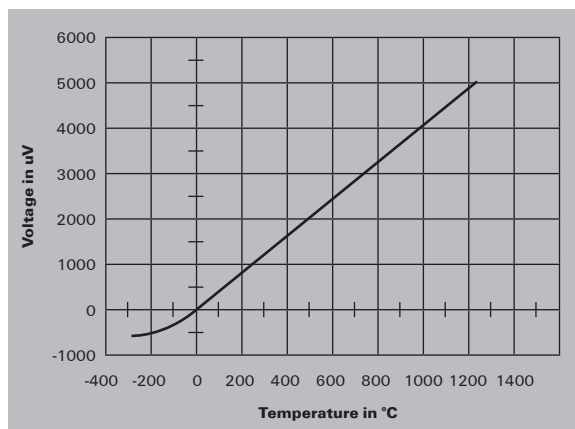

Threshold monitoring	The limiting values of physical variables must be continually monitored for industrial processes. This includes fill levels, temperatures, speed, positions, weights and frequencies. Specialised threshold monitoring components are used for this purpose. The sensor signals are captured on the input side, evaluated electronically and converted. The corresponding threshold (min/max) are then made available via the digital switching outputs (relays or transistors) to the external devices. Potentiometers can be used to customise each switching point and its minimum/maximum threshold as well as the switching hysteresis.
Transformer-based current measurement	Signal converters with transformer coupling are used for taking cost-effective measurements of sinusoidal currents (50/60 Hz). The current being measured flows directly through the primary coil of the measurement transformer. It is then stepped down and electronically processed in the converter.
True RMS value	True RMS is the measure of the active component of alternating current and voltages. The root mean square (RMS) is a measure of the magnitude of varying quantities (such as alternating current and voltage). It is a constant value that relates to the power consumed by a resistive load in a specified time period. The RMS is dependent on the amplitude and the curve slope. Non-sinusoidal signals can only be measured and processed with "true RMS"-compliant devices.
TTY	<p>The TTY interface is a serial interface. This interface is often referred to as a 20-mA-current interface since a constant DC current of 20 mA flows through it during the idle state. In contrast to RS232, the data transmission for the asymmetric signal connection is not controlled by voltage changes but by a load-independent line current (typically 20 mA for High and 0 mA for Low). Thus there is no significant length-dependent voltage loss to take into consideration. Here the cable lengths can run up to several kilometres.</p> <p>TTY interfaces are currently used mostly where dedicated connections are required: for exchanging data between electronic scales, for large industrial displays, or for log printers.</p>
Type of contact	<p>A contact is called normally open (NO) or a make contact if it is open when the armature is dropped out (no current in coil) and closed when the armature is picked up (current flowing in coil). A contact is called a break contact or normally closed (NC) contact if it interrupts the circuit when the armature is picked up. A combination of NC and NO is called a changeover (CO) contact. A relay may have one or more of such contacts:</p> <p>NC – Normally Closed = break contact (11, 12: NC contact) NO – Normally Open = make contact (13, 14: NO contact) CO – Change Over contact (11, 12, 14: CO contact (11 is the shared (root) contact))</p>

Z

Zone division

Hazardous areas are divided into zones. These divisions take into account the various risks from explosive atmospheres. The corresponding explosion protection can then be implemented economically and safely in accordance with the particular conditions of the zone. The zone definitions in the ATEX directive provide comprehensive regulations for the European Community.

IEC 60079-10 is valid for gases and vapours. A similar classification is used for facilities in the USA which are covered by the US standard NEC 505.

IEC 61241-3 covers the division into zones according to the dust level.

Explosion risk areas are classified into zones according to likelihood of explosive atmospheres occurring and their persistence:

Zone 0: this zone has an explosive atmosphere that is a mixture of air and flammable gases, vapours or mists. The mixture is present frequently or over long periods.

Zone 1: an explosive atmosphere may occasionally occur in this zone under normal operating conditions.

Zone 2: an explosive atmosphere is not likely to occur in this zone or may only occur briefly.

Zone 20: this zone has an explosive atmosphere that is a flammable mixture of air and dust. The mixture is present often or over long periods.

Zone 21: an explosive atmosphere, in the form of a flammable dust/air mixture, may occasionally occur in this zone under normal operating conditions.

Zone 22: an explosive atmosphere, in the form of a flammable dust/air mixture, is not likely to occur in this zone or may only occur briefly.

W

Glossar

W

Index

Index	Index Type	X.2
	Index Order No.	X.3

Type	Order No.	Page
A		
ACT20-FEED-IN-BASIC-S	1282490000	C.29
ACT20-FEED-IN-BASIC-S	1282490000	G.9
ACT20-FEED-IN-PRO-S	8965500000	C.29
ACT20-FEED-IN-PRO-S	8965500000	G.9
ACT20C-AI-AD-MTCP	1334490000	D.7
ACT20M-2CI-2CO-ILP-S	1176080000	C.18
ACT20M-2CI-2CO-OLP-S	1176050000	C.19
ACT20M-AI-2AO-S	1176020000	C.11
ACT20M-AI-AO-E-S	1176010000	C.15
ACT20M-AI-AO-S	1176000000	C.14
ACT20M-BAI-2AO-S	1375470000	C.12
ACT20M-BAI-AO-S	1375450000	C.16
ACT20M-CI-2CO-S	1175990000	C.10
ACT20M-CI-CO-ILP-S	1176070000	C.18
ACT20M-CI-CO-OLP-S	1176040000	C.19
ACT20M-CI-CO-S	1175980000	C.13
ACT20M-RTCI-CO-OLP-S	1435690000	C.20
ACT20M-RTI-AO-E-S	1375620000	C.23
ACT20M-RTI-AO-S	1375510000	C.22
ACT20M-RTCI-EOLP-S	1435610000	C.21
ACT20M-TCI-AO-E-S	1375500000	C.25
ACT20M-TCI-AO-S	1375480000	C.24
ACT20M-UI-AO-S	1176030000	C.17
ACT20P-2CI-2CO-12	7760054117	D.13
ACT20P-BRDGE-S	1067250000	D.17
ACT20PCI-2CO	7760054115	D.11
ACT20PCI-CO	7760054114	D.12
ACT20X-2HAI-2SAO-S	8965440000	B.7
ACT20X-2HDI-2SDO-RNC-S	8965380000	B.17
ACT20X-2HDI-2SDO-RNO-S	8965370000	B.19
ACT20X-2HDI-2SDO-S	8965390000	B.18
ACT20X-2HTI-2SAO-S	8965480000	B.11
ACT20X-2SAI-2HAO-S	8965460000	B.9
ACT20X-2SDI-2HDO-S	8965420000	B.21
ACT20X-CJC-HTI-S PRT 11	1160640000	G.10
ACT20X-CJC-HTI-S PRT 21	1160650000	G.10
ACT20X-HAI-2AO-S	8965430000	B.7
ACT20X-HDI-SDO-RNC-S	8965350000	B.17
ACT20X-HDI-SDO-RNO-S	8965340000	B.17
ACT20X-HDI-SDO-S	8965360000	B.19
ACT20X-HTI-2AO-S	8965470000	B.11
ACT20X-HUI-2AO-LP-S	1318220000	B.15
ACT20X-HUI-2AO-S	8965490000	B.13
ACT20X-SAI-2HAO-S	8965450000	B.9
ACT20X-SDI-HDO-H-S	8965410000	B.23
ACT20X-SDI-HDO-L-S	8965400000	B.21
AMS400A 4-20mA/AO	7940011895	F.17
AP MCZ1.5	8389030000	G.12

B		
BHZ 5.00/02/90LH BK/BK PRT 41	1086040000	G.10
BHZ 5.00/02/90LH BK/BL PRT 11	1086250000	G.10
BHZ 5.00/02/90LH BK/BL PRT 21	1086260000	G.10
BHZ 5.00/04/90LH BK/BK PRT 11	1086130000	G.10
BHZ 5.00/04/90LH BK/BK PRT 15	1086190000	G.10
BHZ 5.00/04/90LH BK/BK PRT 21	1086140000	G.10
BHZ 5.00/04/90LH BK/BK PRT 25	1086200000	G.10
BHZ 5.00/04/90LH BK/BK PRT 31	1086150000	G.10
BHZ 5.00/04/90LH BK/BK PRT 35	1086210000	G.10
BHZ 5.00/04/90LH BK/BK PRT 41	1086160000	G.10
BHZ 5.00/04/90LH BK/BK PRT 45	1086220000	G.10
BHZ 5.00/04/90LH BK/BK PRT 51	1086170000	G.10
BHZ 5.00/04/90LH BK/BK PRT 55	1086230000	G.10
BHZ 5.00/04/90LH BK/BK PRT 61	1086180000	G.10
BHZ 5.00/04/90LH BK/BK PRT 65	1086240000	G.10
BHZ 5.00/04/90LH BK/BL PRT 11	1086370000	G.10
BHZ 5.00/04/90LH BK/BL PRT 15	1086430000	G.10
BHZ 5.00/04/90LH BK/BL PRT 21	1086380000	G.10
BHZ 5.00/04/90LH BK/BL PRT 25	1086440000	G.10
BHZ 5.00/04/90LH BK/BL PRT 31	1086390000	G.10
BHZ 5.00/04/90LH BK/BL PRT 35	1086450000	G.10
BHZ 5.00/04/90LH BK/BL PRT 41	1086400000	G.10
BHZ 5.00/04/90LH BK/BL PRT 45	1086460000	G.10
BHZ 5.00/04/90LH BK/BL PRT 51	1086410000	G.10
BHZ 5.00/04/90LH BK/BL PRT 55	1086470000	G.10
BHZ 5.00/04/90LH BK/BL PRT 61	1086420000	G.10
BHZ 5.00/04/90LH BK/BL PRT 65	1086480000	G.10
BLZ 5.08/02/180 SN OR BX	1526460000	G.13
BLZ 5.08/02/180 SN OR PRT	2246070000	G.13
BLZ 5.08/02/180 SN OR PRT	2246080000	G.13
BLZ 5.08/02/180 SN OR PRT	2246090000	G.13
BLZ 5.08/02/180 SN OR PRT	2246100000	G.13
BLZ 5.08/03/180 SN OR PRT	2242030000	G.13
BLZ 5.08/03/180 SN OR PRT	2242050000	G.13
BLZ 5.08/03/180 SN OR PRT	2242060000	G.13
BLZ 5.08/03/180 SN OR PRT	2242070000	G.13

C		
CBX100USB	7940025031	G.5
CBX200 USB	8978580000	G.4
CH20M BUS 4.50/05 AU/250	1248220000	C.27
CH20M BUS 4.50/05 AU/250	1248220000	G.7
CH20M BUS 4.50/05 AU/500	1248230000	C.27
CH20M BUS 4.50/05 AU/500	1248230000	G.7
CH20M BUS 4.50/05 AU/750	1248240000	C.27

Type	Order No.	Page
CH20M BUS 4.50/05 AU/750	1248240000	G.7
CH20M BUS-ADP TS 35/250	1248250000	C.27
CH20M BUS-ADP TS 35/250	1248250000	G.7
CH20M BUS-ADP TS 35/500	1248260000	C.27
CH20M BUS-ADP TS 35/500	1248260000	G.7
CH20M BUS-ADP TS 35/750	1248270000	C.27
CH20M BUS-ADP TS 35/750	1248270000	G.7
CH20M BUS-AP LI TS 35X7.5 & 15	1193160000	C.27
CH20M BUS-AP LI TS 35X7.5 & 15	1193160000	G.7
CH20M BUS-AP RE TS 35X7.5 & 15	1193170000	C.27
CH20M BUS-AP RE TS 35X7.5 & 15	1193170000	G.7
CH20M BUS-PROFIL TS 35X15/250	1248180000	C.27
CH20M BUS-PROFIL TS 35X15/250	1248180000	G.7
CH20M BUS-PROFIL TS 35X15/500	1248190000	C.27
CH20M BUS-PROFIL TS 35X15/500	1248190000	G.7
CH20M BUS-PROFIL TS 35X15/750	1248210000	C.27
CH20M BUS-PROFIL TS 35X15/750	1248210000	G.7
CH20M BUS-PROFIL TS 35X7.5/250	1248150000	C.27
CH20M BUS-PROFIL TS 35X7.5/250	1248150000	G.7
CH20M BUS-PROFIL TS 35X7.5/500	1248160000	C.27
CH20M BUS-PROFIL TS 35X7.5/500	1248160000	G.7
CH20M BUS-PROFIL TS 35X7.5/750	1248170000	C.27
CH20M BUS-PROFIL TS 35X7.5/750	1248170000	G.7

D		
DI350 0-10V/0-100.0	7940011570	F.19
DI350 4-20mA/0-100.0	7940010185	F.19

E		
ESG 6.6/20 BHZ 5.00/04	1082540000	G.10
ESG 8/13.5/43.3 SAI AU	1912130000	G.10
ESG 8/13.5/43.3 SAI AU	1912130000	G.11

I		
ITXplus	7940016563	D.25

L		
LPD350 4-20mA/0-100.0	7940010163	F.21
LPD450F 4-20mA	7940010236	F.23

M		
MCZ CCC 0-20mA/0-20mA	8411190000	C.32
MCZ CFC 0-20MA	8461480000	C.34
MCZ PT100/3 CLP 40C..100C	8604430000	C.33
MCZ PT100/3 CLP 50C..+150C	8473000000	C.33
MCZ PT100/3 CLP 0..100C	8425720000	C.33
MCZ PT100/3 CLP 0..120C	8483680000	C.33
MCZ PT100/3 CLP 0..150C	8604420000	C.33
MCZ PT100/3 CLP 0..200C	8473010000	C.33
MCZ PT100/3 CLP 0..300C	8473020000	C.33
MCZ SC 0-10V	8260280000	C.35
MCZ SC 0-20MA	8227350000	C.35
MCZ VFC 0-10V	8461470000	C.34
MF 5/7.5 MC NE WS	1877680000	G.11

P		
P275	7940010202	G.17
PAS CMR 0,5...2,5 A DC	8742610000	E.6
PAS CMR 2,0...5,0 A DC	8742620000	E.6
PAS CMR 4,5...10 A DC	8742630000	E.7
PMX400HXZ	7940015595	F.15
PMX400HXZ RO/AO	7940011979	F.15
PMX400TMP	7940017862	F.14
PMX420	7940018956	F.11
PMX420Plus	7940018957	F.10
PORTACAL 1000EU	1439640000	G.15
PTX800A 4-20mA	7940010243	F.7
PTX800A 4-20mA/RO/AO	7940014374	F.7
PTX800D	7940011133	F.6
PTX800D RO/AO	7940012323	F.6

S		
SET CH20M BUS 250MM TS 35X15	1335150000	C.27
SET CH20M BUS 250MM TS 35X15	1335150000	G.7
SET CH20M BUS 250MM TS 35X7.5	1335140000	C.27
SET CH20M BUS 250MM TS 35X7.5	1335140000	G.7

T		
TS 35X15/LL 1M/ST/ZN	0236510000	C.27
TS 35X15/LL 1M/ST/ZN	0236510000	G.7
TS 35X7.5/LL 1M/ST/ZN	0514510000	C.27
TS 35X7.5/LL 1M/ST/ZN	0514510000	G.7

W		
WAS1 CMA 1/5/10A ac	8523400000	D.58
WAS1 CMA LP 1/5/10A ac	8528650000	D.58
WAS1 CMA LP 1/5/10A EX	8975590000	D.59
WAS2 CMA 20/25/30A uc	8545830000	D.56
WAS2 CMA 40/50/60A uc	8513330000	D.57
WAS2 CMA 5/10A uc	8526610000	D.56

Type	Order No.	Page
WAS2 CMR 1/5/10A ac	8516560000	E.5
WAS2 CMR 20/40/60A ac	8513340000	E.5
WAS2 VMA V ac	8581220000	D.60
WAS2 VMR 3ph	8705630000	E.9
WAS4 CCC DC 4-20/0-20MA	8445010000	D.38
WAS4 CCC DC 4-20/4-20MA	8444980000	D.38
WAS4 CVC DC 4-20/0-10V	8445040000	D.39
WAS4 PRO DC/DC	8560740000	D.26
WAS4 PRO Freq	8581180000	D.55
WAS5 CCC 0-20/4-20mA	8540250000	D.32
WAS5 CCC 0-20/0-20mA	8540180000	D.32
WAS5 CCC 20LP	8581160000	D.40
WAS5 CCC 20LP EX	8975640000	D.41
WAS5 CCC 4-20/0-20MA	8540200000	D.34
WAS5 CCC HF 0-20/0-20MA	8447160000	D.28
WAS5 CCC HF 4-20/0-20MA	8447250000	D.29
WAS5 CCC LP 0-20/0-20mA	8444950000	D.43
WAS5 CCC LP 0-20/0-20mA	8463580000	D.43
WAS5 CVC 0-20mA/0-10V	8540270000	D.33
WAS5 CVC 4-20mA/0-10V	8540230000	D.34
WAS5 CVC HF 0-20/0-10V	8447220000	D.28
WAS5 CVC HF 4-20/0-10V	8447280000	D.29
WAS5 DC/Alarm	8543820000	E.4
WAS5 OLP	8543720000	D.42
WAS5 PRO RTD	8560700000	D.44
WAS5 PRO RTD 1000	8679490000	D.46
WAS5 PRO RTD Cu	8638950000	D.48
WAS5 PRO Thermo	8560720000	D.52
WAS5 VCC 0-10V/0-20MA	8540310000	D.35
WAS5 VCC 0-10V/4-20MA	8540290000	D.35
WAS5 VCC HF 0-10/0-20MA	8447310000	D.30
WAS5 VCC HF 0-10/4-20MA	8447340000	D.30
WAS5 VMR 1ph	8705640000	E.8
WAS5 VVC 0-10V/0-10V	8540330000	D.36
WAS5 VVC HF +-10V/+10V	8561610000	D.31
WAS5 VVC HF 0-10/0-10V	8447370000	D.31
WAS6 TTA	8939670000	D.22
WAS6 TTA EX	8964310000	D.23
WAVEPak DC/DC	7940024139	D.27
WAZ1 CMA 1/5/10A ac	8523410000	D.58
WAZ1 CMA LP 1/5/10A ac	8528660000	D.58
WAZ2 CMA 20/25/30A uc	8545840000	D.56
WAZ2 CMA 40/50/60A uc	8528590000	D.57
WAZ2 CMA 5/10A uc	8526620000	D.56
WAZ2 CMR 1/5/10A ac	8516570000	E.5
WAZ2 CMR 20/40/60A ac	8526600000	E.5
WAZ2 VMA V ac	8581230000	D.60
WAZ4 CCC DC 4-20/4-20MA	8444990000	D.38
WAZ4 CVC DC 4-20/0-10V	8445050000	D.39
WAZ4 PRO DC/DC	8560750000	D.26
WAZ4 PRO Freq	8581190000	D.55
WAZ5 CCC 0-20/0-20mA	8540190000	D.32

Order No.	Type	Page
-----------	------	------

1060000000

1067250000	ACT20P-BRIDGE-S	D.17
------------	-----------------	------

1080000000

1082540000	ESG 6.6/20 BHZ 5.00/04	G.10
1086040000	BHZ 5.00/02/90LH BK/BK PRT 41	G.10
1086130000	BHZ 5.00/04/90LH BK/BK PRT 11	G.10
1086140000	BHZ 5.00/04/90LH BK/BK PRT 21	G.10
1086150000	BHZ 5.00/04/90LH BK/BK PRT 31	G.10
1086160000	BHZ 5.00/04/90LH BK/BK PRT 41	G.10
1086170000	BHZ 5.00/04/90LH BK/BK PRT 51	G.10
1086180000	BHZ 5.00/04/90LH BK/BK PRT 61	G.10
1086190000	BHZ 5.00/04/90LH BK/BK PRT 15	G.10
1086200000	BHZ 5.00/04/90LH BK/BK PRT 25	G.10
1086210000	BHZ 5.00/04/90LH BK/BK PRT 35	G.10
1086220000	BHZ 5.00/04/90LH BK/BK PRT 45	G.10
1086230000	BHZ 5.00/04/90LH BK/BK PRT 55	G.10
1086240000	BHZ 5.00/04/90LH BK/BK PRT 65	G.10
1086250000	BHZ 5.00/02/90LH BK/BL PRT 11	G.10
1086260000	BHZ 5.00/02/90LH BK/BL PRT 21	G.10
1086370000	BHZ 5.00/04/90LH BK/BL PRT 11	G.10
1086380000	BHZ 5.00/04/90LH BK/BL PRT 21	G.10
1086390000	BHZ 5.00/04/90LH BK/BL PRT 31	G.10
1086400000	BHZ 5.00/04/90LH BK/BL PRT 41	G.10
1086410000	BHZ 5.00/04/90LH BK/BL PRT 51	G.10
1086420000	BHZ 5.00/04/90LH BK/BL PRT 61	G.10
1086430000	BHZ 5.00/04/90LH BK/BL PRT 15	G.10
1086440000	BHZ 5.00/04/90LH BK/BL PRT 25	G.10
1086450000	BHZ 5.00/04/90LH BK/BL PRT 35	G.10
1086460000	BHZ 5.00/04/90LH BK/BL PRT 45	G.10
1086470000	BHZ 5.00/04/90LH BK/BL PRT 55	G.10
1086480000	BHZ 5.00/04/90LH BK/BL PRT 65	G.10

1160000000

1160640000	ACT20X-CJCHTS-PR1	G.10
1160650000	ACT20X-CJCHTS-PR2	G.10

1170000000

1175980000	ACT20M-CI-CO-S	C.13
1175990000	ACT20M-CI-2CO-S	C.10
1176000000	ACT20M-AI-AO-S	C.14
1176010000	ACT20M-AI-AO-E-S	C.15
1176020000	ACT20M-AI-2AO-S	C.11
1176030000	ACT20M-AI-AO-S	C.17
1176040000	ACT20M-CI-CO-OLP-S	C.19
1176050000	ACT20M-2CI-2CO-OLP-S	C.19
1176070000	ACT20M-CI-CO-ILP-S	C.18
1176080000	ACT20M-2CI-2CO-ILP-S	C.18

1190000000

1193160000	CH20M BUS-AP LI TS 35X7.5 & 15	C.27
1193160000	CH20M BUS-AP LI TS 35X7.5 & 15	G.7
1193170000	CH20M BUS-AP RE TS 35X7.5 & 15	C.27
1193170000	CH20M BUS-AP RE TS 35X7.5 & 15	G.7

1240000000

1248150000	CH20M BUS-PROFIL TS 35X7.5/250	C.27
1248150000	CH20M BUS-PROFIL TS 35X7.5/250	G.7
1248160000	CH20M BUS-PROFIL TS 35X7.5/500	C.27
1248160000	CH20M BUS-PROFIL TS 35X7.5/500	G.7
1248170000	CH20M BUS-PROFIL TS 35X7.5/750	C.27
1248170000	CH20M BUS-PROFIL TS 35X7.5/750	G.7
1248180000	CH20M BUS-PROFIL TS 35X15/250	C.27
1248180000	CH20M BUS-PROFIL TS 35X15/250	G.7
1248190000	CH20M BUS-PROFIL TS 35X15/500	C.27
1248190000	CH20M BUS-PROFIL TS 35X15/500	G.7
1248210000	CH20M BUS-PROFIL TS 35X15/750	C.27
1248210000	CH20M BUS-PROFIL TS 35X15/750	G.7
1248220000	CH20M BUS 4.50/05 AU/250	C.27
1248220000	CH20M BUS 4.50/05 AU/250	G.7
1248230000	CH20M BUS 4.50/05 AU/500	C.27
1248230000	CH20M BUS 4.50/05 AU/500	G.7
1248240000	CH20M BUS 4.50/05 AU/750	C.27
1248240000	CH20M BUS 4.50/05 AU/750	G.7
1248250000	CH20M BUS-ADP TS 35/250	C.27
1248250000	CH20M BUS-ADP TS 35/250	G.7
1248260000	CH20M BUS-ADP TS 35/500	C.27
1248260000	CH20M BUS-ADP TS 35/500	G.7
1248270000	CH20M BUS-ADP TS 35/750	C.27
1248270000	CH20M BUS-ADP TS 35/750	G.7

1280000000

1282490000	ACT20-FEED-IN-BASIC-S	C.29
1282490000	ACT20-FEED-IN-BASIC-S	G.9

1310000000

1318220000	ACT20X-HUI-SAO-ILP-S	B.15
------------	----------------------	------

1330000000

1334490000	ACT20C-AI-AO-MTCP	D.7
------------	-------------------	-----

Order No.	Type	Page
-----------	------	------

1335140000	SET CH20M BUS 250MM TS 35X7.5	C.27
1335140000	SET CH20M BUS 250MM TS 35X7.5	G.7
1335150000	SET CH20M BUS 250MM TS 35X15	C.27
1335150000	SET CH20M BUS 250MM TS 35X15	G.7

1370000000

1375450000	ACT20M-BAI-AO-S	C.16
1375470000	ACT20M-BAI-2AO-S	C.12
1375480000	ACT20M-TCH-AO-E-S	C.24
1375500000	ACT20M-TCH-AO-E-S	C.25
1375510000	ACT20M-RTH-AO-S	C.22
1375520000	ACT20M-RTH-AO-E-S	C.23

1430000000

1435590000	ACT20M-RTCI-CO-OLP-S	C.20
1435610000	ACT20M-RTCI-CO-OLP-S	C.21
1439640000	PORTACAL 1000EU	G.15

1520000000

1526460000	BLZ 5.08/02/180 SN OR BX	G.13
------------	--------------------------	------

1600000000

1609880000	WS 15/5 MC NE WS	G.12
------------	------------------	------

1630000000

1635000000	WS 10/5 MC NE WS	G.12
------------	------------------	------

1690000000

1693800000	ZQV 2.5N/2 GE	G.12
------------	---------------	------

1710000000

1717900000	ZQV 2.5N/2 RT	G.12
1717990000	ZQV 2.5N/2 BL	G.12
1718080000	ZQV 2.5N/2 SW	G.12

1750000000

1758250000	ZQV 4N/2 GE	G.12
1758260000	ZQV 4N/10 GE	G.12

1760000000

1762620000	ZQV 4N/4 GE	G.12
1762630000	ZQV 4N/3 GE	G.12

1820000000

1828450000	WS 10/6 MC NE WS	G.12
------------	------------------	------

1870000000

1877680000	MF 5/7.5 MC NE WS	G.11
------------	-------------------	------

1910000000

1912130000	ESG 8/13.5/43.3 SAI AU	G.10
1912130000	ESG 8/13.5/43.3 SAI AU	G.11

2240000000

2242030000	BLZ 5.08/03/180 SN OR PRT	G.13
2242050000	BLZ 5.08/03/180 SN OR PRT	G.13
2242060000	BLZ 5.08/03/180 SN OR PRT	G.13
2242070000	BLZ 5.08/03/180 SN OR PRT	G.13
2242070000	BLZ 5.08/02/180 SN OR PRT	G.13
2246070000	BLZ 5.08/02/180 SN OR PRT	G.13
2246080000	BLZ 5.08/02/180 SN OR PRT	G.13
2246090000	BLZ 5.08/02/180 SN OR PRT	G.13
2246100000	BLZ 5.08/02/180 SN OR PRT	G.13

7760000000

7760054114	ACT20P-CI-CO	D.12
7760054115	ACT20P-CI-2CO	D.11
7760054117	ACT20P-2CI-2CO-12	D.13
7760711001	ZQV 4N/5	G.12

7940000000

7940010163	LPD350 4-20mA/0-100.0	F.21
7940010185	DI350 4-20mA/0-100.0	F.19
7940010202	P275	G.17
7940010236	LPD450F 4-20mA	F.23
7940010243	PTX800A 4-20mA	F.7
7940011133	PTX800D	F.6
7940011570	DI350 0-10V/0-100.0	F.19
7940011895	AMS400A 4-20mA/AO	F.17
7940011979	PMX400HZX RO/AO	F.15
7940012323	PTX800D RO/AO	F.6
7940014374	PTX800A 4-20mA/RO/AO	F.7
7940015595	PMX400HZX	F.15
7940016563	ITXPlus	D.25
7940017862	PMX400T1MP	F.14

Order No.	Type	Page
-----------	------	------

7940018956	PMX420	F.11
7940018957	PMX420Plus	F.10
7940024139	WAVEPak DC/DC	D.27
7940025031	CBX100USB	G.5

8220000000

8227350000	MCZ SC 0-20MA	C.35
8260280000	MCZ SC 0-10V	C.35

8380000000

8389030000	AP MCZ1.5	G.12
------------	-----------	------

8410000000

8411190000	MCZ CCC 0-20mA/0-20mA	C.32
------------	-----------------------	------

8420000000

8425720000	MCZ PT100/3 CLP 0...100C	C.33
------------	--------------------------	------

8430000000

8432130000	WTZ4 PT100/3 V 0-10V	D.50
8432160000	WTZ4 PT100/3 C 0/4-20mA	D.50
8432169999	WTZ4 PT100/3 C 0/4-20mA variabel	D.50
8432190000	WTZ4 PT100/2 V 0-10V	D.51
8432199999	WTZ4 PT100/2 V 0-10V variabel	D.51
8432220000	WTZ4 PT100/2 C 0/4-20mA	D.51
8432229999	WTZ4 PT100/2 C 0/4-20mA variabel	D.51
8432250000	WTZ4 PT100/4 V 0-10V	D.49
8432259999	WTZ4 PT100/4 V 0-10V variabel	D.49
8432280000	WTZ4 PT100/4 C 0/4-20mA	D.49
8432289999	WTZ4 PT100/4 C 0/4-20mA variabel	D.49
8432300000	WTS4 THERMO	D.53
8432310000	WTZ4 THERMO	D.53

8440000000

8444950000	WAS5 CCC LP 0-20/0-20mA	D.43
8444960000	WAZ5 CCC LP 0-20/0-20mA	D.43
8444980000	WAS4 CCC DC 4-20/4-20MA	D.38
8444990000	WAZ4 CCC DC 4-20/4-20MA	D.38
8445010000	WAS4 CCC DC 4-20/0-20MA	D.38
8445040000	WAS4 CVC DC 4-20/0-10V	D.39
8445050000	WAZ4 CVC DC 4-20/0-10V	D.39
8447160000	WAS5 CCC HF 0-20/0-20MA	D.28
8447170000	WAZ5 CCC HF 0-20/0-20MA	D.28
8447220000	WAS5 CVC HF 0-20/0-10V	D.28
8447250000	WAS5 CCC HF 4-20/0-20MA	D.29
8447280000	WAS5 CVC HF 4-20/0-10V	D.29
8447310000	WAS5 VCC HF 0-10/0-20MA	D.30
8447340000	WAS5 VCC HF 0-10/4-20MA	D.30
8447370000	WAS5 VVC HF 0-10/0-10V	D.31
8447380000	WAZ5 VVC HF 0-10/0-10V	D.31

8460000000

8461470000	MCZ VFC 0-10V	C.34
8461480000	MCZ CFC 0-20MA	C.34
8463580000	WAS5 CCC LP 0-20/0-20mA	D.43
8		

Order No.	Type	Page
-----------	------	------

0236510000	TS 35X15/LL 1M/ST/ZN	G.7
------------	----------------------	-----

051000000

0514510000	TS 35X7.5/LL 1M/ST/ZN	C.27
0514510000	TS 35X7.5/LL 1M/ST/ZN	G.7

We cannot guarantee that there are no mistakes in the publications or software provided by us to the customer for the purpose of making orders. We try our best to quickly correct errors in our printed media.

X

All orders are based on our general terms of delivery, which can be reviewed on the websites of our group companies where you place your order. On demand we can also send the general terms of delivery to you.

Weidmüller – Your partner in Industrial Connectivity

As experienced experts we support our customers and partners around the world with products, solutions and services in the industrial environment of power, signal and data. We are at home in their industries and markets and know the technological challenges of tomorrow. We are therefore continuously developing innovative, sustainable and useful solutions for their individual needs. Together we set standards in Industrial Connectivity.

Weidmüller Interface GmbH & Co. KG
Klingenbergstraße 16
32758 Detmold, Germany
T +49 5231 14-0
F +49 5231 14-292083
info@weidmueller.com
www.weidmueller.com

Your local Weidmüller partner can
be found on our website:
www.weidmueller.com/countries

Made in Germany



Order number: 1460730000/10/2013/SMDM